



Revision Solutions

ATTUNE® REVISION
KNEE SYSTEM
FIXED BEARING
SURGICAL TECHNIQUE



Introduction

This surgical technique provides guidelines for the implantation of the ATTUNE® Revision Knee System.

ATTUNE Revision Knee System Fixed Bearing (FB) Implants include the following components:

- ATTUNE Revision Femoral Component
- ATTUNE Revision Fixed Bearing Insert
- ATTUNE Revision Fixed Bearing Tibial Base
- ATTUNE Revision Press-Fit and Cemented Stems
- ATTUNE Revision Femoral Augments
- ATTUNE Revision Tibial Augments
- ATTUNE Revision Offset Adaptors
- ATTUNE Revision Femoral Sleeves



INFORMATION

Use of supplemental fixation components (Stems and/or Sleeves) is recommended when using Augments or a constrained (Revision) Insert. Use of the Revision Insert or Augments without supplemental fixation may lead to a loss of construct fixation.



INFORMATION

The ATTUNE Revision Femoral Component is compatible with the ATTUNE PS Fixed Bearing Tibial Insert and the ATTUNE Revision Fixed Bearing Tibial Insert. The ATTUNE PS FB Insert can be used with the ATTUNE Revision Femoral Component when less constraint is desired.

Contents

Abbreviations	6
Icons	7
Key Surgical Steps Summary	8
Pre-operative Planning	10
1. Incision and Exposure	
Initial Incision, Capsular Incision and Implant Extraction from the Primary Procedure	11
2. ATTUNE Revision Knee General Instrumentation	
Pinning	12
Touch-points	13
Angled Pin Holes	14
Reamer Reference Tools	15
Canal Reamers	18
Torque Limiting Screwdriver and System Hex Attachment	21
Modular Stop	22
Stem Trial Assembly	23
Stem Trial and Stem Stabilizer Extraction	24
3. Tibial Preparation	
Tibial Trial Assembly	25
Anterior Pins	26
Tibial Preparation - Solutions	27
■ Solution 1: Revision Fixed Bearing (FB) Base alone or with Short Cemented Stem Preparation (Extramedullary Preparation)	28
■ Solution 2: Revision Fixed Bearing (FB) Base with Straight Stem or Offset Stem Preparation (Intramedullary Preparation)	40
4. Revision Femoral Preparation	
General Femoral Instrumentation	54
Revision Femoral Preparation - Solutions	62
■ Solution 1: Revision Femoral Component with Short Cemented Stem (With Cut Through Trials)	63
■ Solution 2: Revision Femoral Component with Short Cemented Stem (With Solid Femoral Trials)	68
■ Solution 3: Revision Femoral Component with Intramedullary Preparation (With Conventional Cut Guide)	74
Revision Femoral Component with Intramedullary Preparation (With FE Guide)	74
■ Solution 4: Revision Femoral Component with Intramedullary Preparation (With Cut Through Trials)	74
5. Trialing and Final Preparation	
Setting Tibial Base Rotation	151
Tibial Augment Preparation	155
Keel Preparation	157
6. Patella Resection and Preparation	
Patella Resection and Preparation – Instrument Assembly	158
Patella Resection	160
Patella Implant Options	162
Patella Drill Trialing	163
Lug Hole Preparation	165

7. Final Trial Assessment	
Final Trial Assessment	166
8. Trial Removal	
Femoral Trial Removal	167
Tibial Trial Removal	168
9. Implant Assembly	
Implant Assembly	169
Augment Assembly	170
Tibial Augment Assembly	171
Femoral Augment Assembly	172
Revision FB Tibial Base and Straight Stem Implant Assembly	173
Revision Femoral Component and Straight Stem Implant Assembly	176
Alternative Revision Femoral Component and Straight Stem Implant Assembly	180
Revision FB Tibial Base and Offset Stem Implant Assembly	182
Revision Femoral Component and Offset Stem Implant Assembly	190
Revision Femoral Component and Femoral Sleeve Assembly	199
10. Cementing Technique	
Cementing Technique	203
Revision FB Tibial Construct alone or with Cemented Stems or Augments	204
Revision FB Tibial Construct with Press-Fit Stems or Augments	205
Revision Femoral Construct with Cemented Stems, Augments, and/or Cemented Sleeves	206
Revision Femoral Construct with Press-Fit Stems and Augments	207
Revision Femoral Construct with Press-Fit Stems and Porous Coated Sleeves and Augments	208
11. Final Implantation	
Seating the Tibial Construct	209
Seating the Femoral Construct	210
Solid Tibial Trial Extraction	211
Tibial Insert Implantation	212
PS or CR Tibial Insert Implantation	213
Final Patella Preparation	214
Patella Component Implantation	215
Final Cement Curing	216
12. Sleeve Disassembly	
Femoral Sleeve Disassembly	217
13. Appendices	
Appendix A: KINCISE™ Surgical Automated System Femoral Broaching	219
Compatibility Information	223
Symbols on Surgical Instruments	224

Abbreviations

Abbreviations used in the surgical technique:

- FB - Fixed Bearing
- TKA - Total Knee Arthroplasty
- MRI - Magnetic Resonance Imaging
- CT - Computerized Tomography
- M/L - Medial/Lateral
- V/V - Varus/Valgus
- A/P - Anterior/Posterior
- EM - Extramedullary
- IM - Intramedullary
- CR - Cruciate Retaining
- CS - Cruciate Sacrificing
- PS - Posterior Stabilized
- PCL - Posterior Cruciate Ligament

Icons

The below icons are utilized within the different preparation solutions to indicate the type of preparation that is being described on the specific page. These are an aid to navigate through a given workflow solution.



Straight Stem



Conventional Cut Guide



Femoral Sleeve and Stem



Cut Through Trial



Offset Stem



Solid Femoral Trial

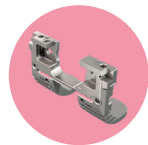

FE Guide

Key Surgical Steps Summary



General Revision
Instrumentation Information



Tibial Preparation

Two Solutions:

- Revision Fixed Bearing (FB) Base alone or with Short Cemented Stem Preparation (Extramedullary Preparation)
- Revision Fixed Bearing (FB) Base with Straight Stem or Offset Stem Preparation (Intramedullary Preparation)



Final Trial Assessment



Implant Assembly

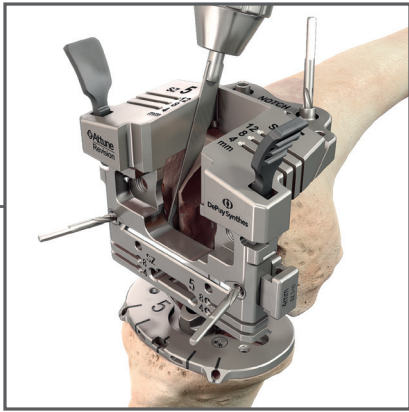

Revision Femoral Preparation



Trialing and Final Preparation

Four Solutions:

- Revision Femoral Component with Short Cemented Stem (With Cut Through Trials)
- Revision Femoral Component with Short Cemented Stem (With Solid Femoral Trials)
- Revision Femoral Component with Intramedullary Preparation (With Conventional Cut Guide)
- Revision Femoral Component with Intramedullary Preparation (With FE Guide)
- Revision Femoral Component with Intramedullary Preparation (With Cut Through Trials)

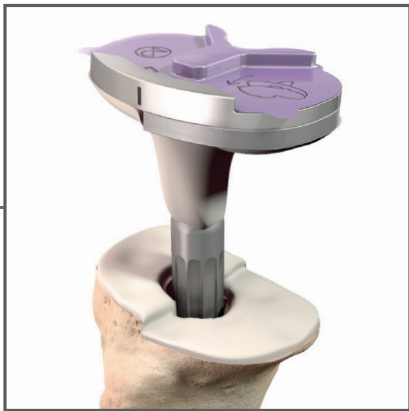

Cementing Technique



Final Implantation

Pre-operative Planning

Revision Total Knee Arthroplasty begins with thorough clinical and X-ray evaluation. Templates are employed to establish replacement implant size and the alignment of bone resections, to indicate augmentation of skeletal deficits, and to confirm the joint line.

Pre-operative X-ray evaluation for the long-axis of tibial and femoral curvature is recommended prior to determining the surgical path for appropriately addressing the needs of the patient. Anatomical curvature should be taken into consideration when determining the Stem length with or without augmentation. The construct length and/or offset should be selected to avoid the area where extreme curvature occurs.

Initial Incision, Capsular Incision and Implant Extraction from the Primary Procedure

Incision and exposure should be performed using the surgeon's preferred surgical technique. When removing/extracting an implant from previous procedure, take care to preserve as much bone as possible.

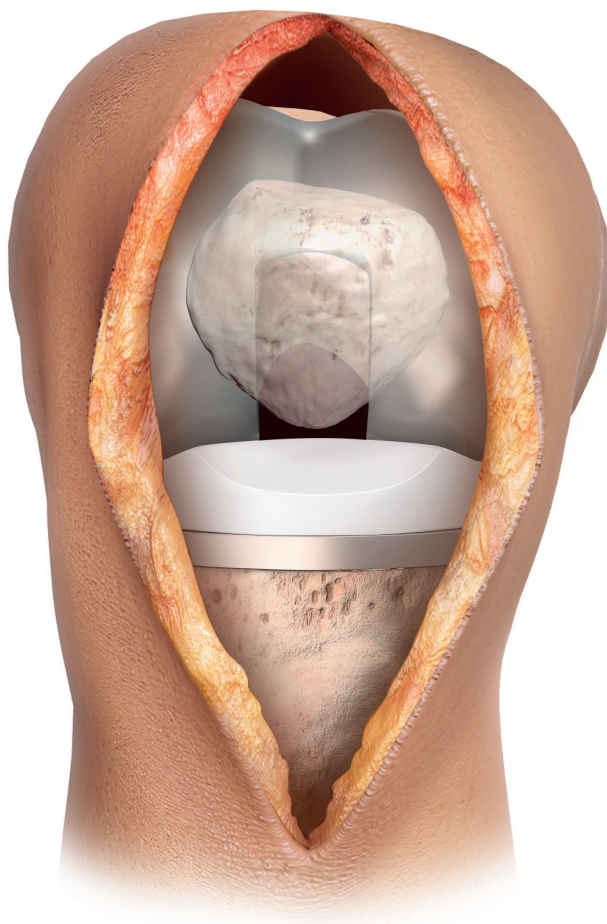

Pinning

The ATTUNE Revision Knee Instrument System is designed to be used with the ATTUNE Knee Pinning System that contains Universal Pins and Threaded Headed Pins. Threaded Non-Headed Pins are also shown but are not available in the Pin Pack.

The Universal Pin can be drilled in or hammered in, and drilled out or pulled out using the Pin Jack.

The Threaded Headed Pin is designed to be inserted and removed with a Power Driver. These Pins are best used to secure blocks against a flat surface such as resected bone. 

The Threaded Non-Headed Pin is also available and is designed to be inserted and removed with a Power Driver.



Universal Pin

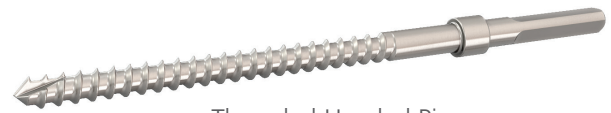

Threaded Headed Pin



Threaded Non-Headed Pin



CAUTION

Care should be taken to not over tighten these Pins with the ATTUNE Revision Knee System Instrumentation as it may change the angle of the Cut Block. Additionally, care should be taken to be aware of the position of the Pin with respect to cortical bone, as cortical perforation with a Pin can be the source of a stress riser.



INFORMATION

Steinmann Pins are compatible with all Pin holes throughout the ATTUNE Revision Knee Instrumentation.



Pin Jack



Power Driver

Touch-points

The Revision Instrumentation System has identified touch-points through a number of methods: Instruments may have the touch-points highlighted red or black.

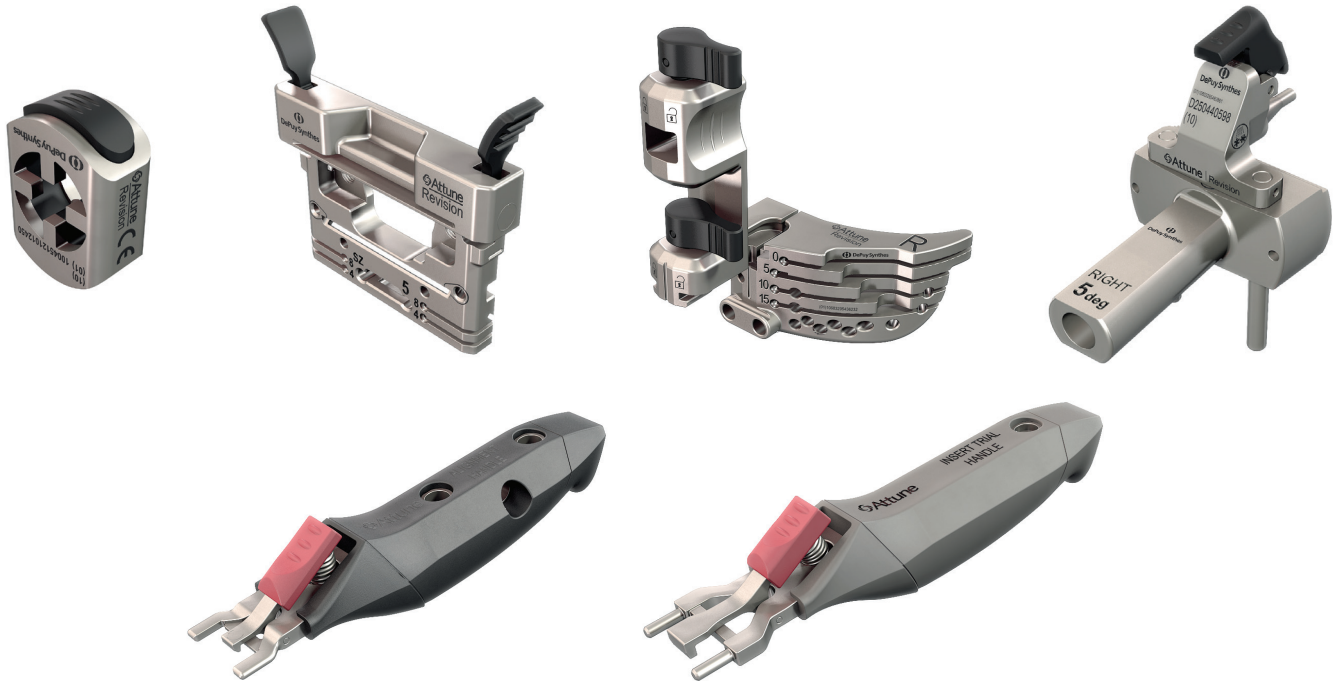

In some instances a marking pattern has been applied to metal components to indicate the touch-points.

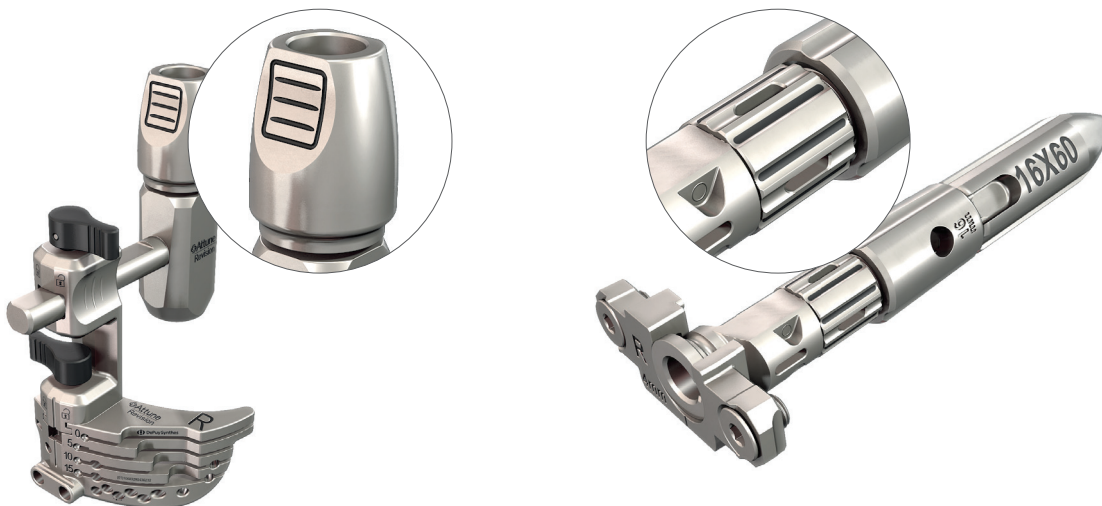

Angled Pin Holes

The following symbol  has been applied over holes to indicate the angled orientation of the Pin hole.

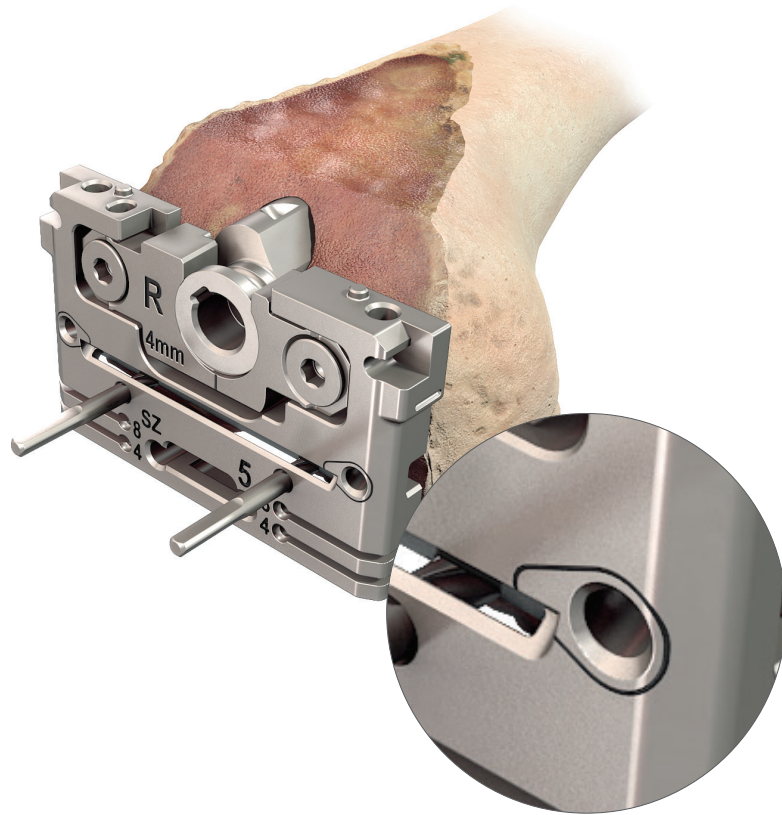

Reamer Reference Tools

Reamer Reference Tools come in three lengths in order to differentiate the various construct configurations for:



- Tibia (shortest Reference Tool)
- Femur (medium length Reference Tool)
- Offset (longest Reference Tool)

The Reference Tools are dual sided:

- Tibia: Fixed Bearing
- Femur: 1) Cemented Stem 2) Press-Fit Stem
- Offset: 1) Tibia 2) Femur
 - The Offset Adaptor adds an additional 25 mm to the overall construct length

The Reference Tools have general depth indication lines sequentially numbered and spaced 20 mm apart.

- The Canal Reamers have grooves that correspond with the depth indication lines

The 3rd, 6th and 9th depth lines are wider in both the Canal Reamers and the Reference Tools to aid in visual identification while reaming.

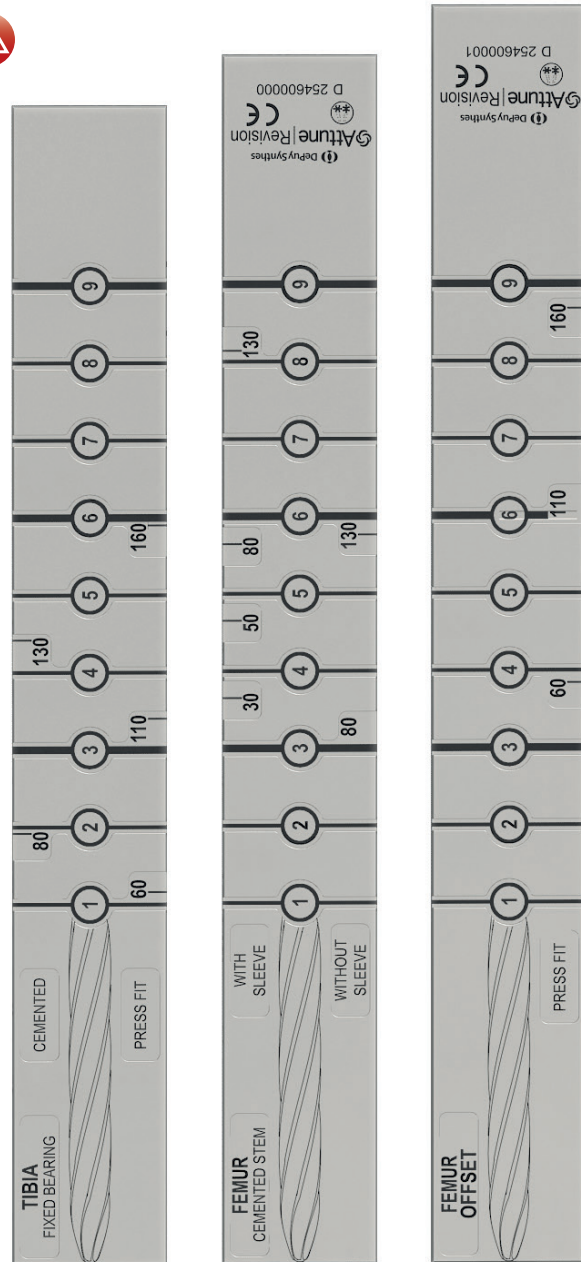

CAUTION

It should be noted that depth lines do not represent the exact construct lengths but rather the ream depth to prevent underpreparation.

Reamer Reference Tools

Select the appropriate side of the desired Reamer Reference Tool to prepare the canal.

Align the Canal Reamer with the scribed image on the Reference Tool. Using the scale, identify the appropriate engraved mark and corresponding number on the Reamer as reference for reaming the canal. If the construct is between Reamer markings, **ream to the next deeper groove.**

If it is determined that Femoral Sleeve Preparation is appropriate to manage the defect, utilize the indicated depth from the Sleeve and Stem markings on the Femur Reference Tool. An example of the Femoral Sleeve and Stem markings are on the following page.

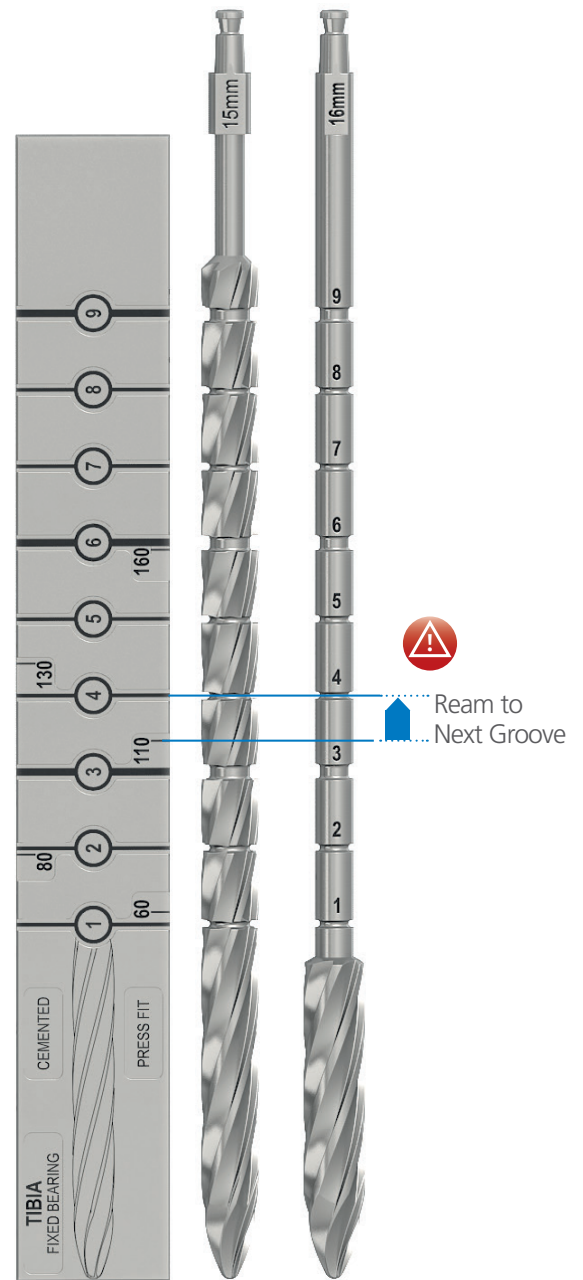

INFORMATION

For the Femur Preparation, the Femoral Box is variable in depth and therefore the depth of reaming is dependent on the size of the femur used. To avoid under-reaming, the Femur Reamer Reference Tools indicate a reaming depth that corresponds to the largest Femoral Box size, and thus for smaller femurs, this could result in slight over-preparation of approximately 9 mm.



CAUTION

Always ream to the next largest groove. If a stem length is very close to or just past or just before a groove, ream to the next groove; as in the example above, which reams to Groove 4 when anticipating a 110 mm Tibial Stem.

Reamer Reference Tools

Example of Reamer Reference Tool use for Press-Fit Stem and Femoral Sleeve:

Either

1. Pre-operative Planning suggested use of 55 mm Sleeve with 60 mm Stem. Ream to Groove 6.

or

2. The Cut Through Trial assessment was performed with a 110 mm Stem Trial and Pre-operative Planning suggested use of a 55 mm Sleeve. To accommodate the Sleeve within the overall construct length, a 60 mm Stem should now be used instead of the 110 mm Stem. Ream to Groove 6. The resultant implant construct (Femoral Component, 60 mm Stem, 55 mm Femoral Sleeve) will align with the Femoral Sleeve Trial construct but will be slightly longer than the 110 mm Stem Trial *without Sleeve* as can be seen by comparing the position of the 55 mm Sleeve and 60 mm Stem versus the 110 mm Stem without Sleeve on the Reamer Reference Tool. Refer to **page 140** for more information on the Cut Through Trial to Femoral Sleeve workflow.

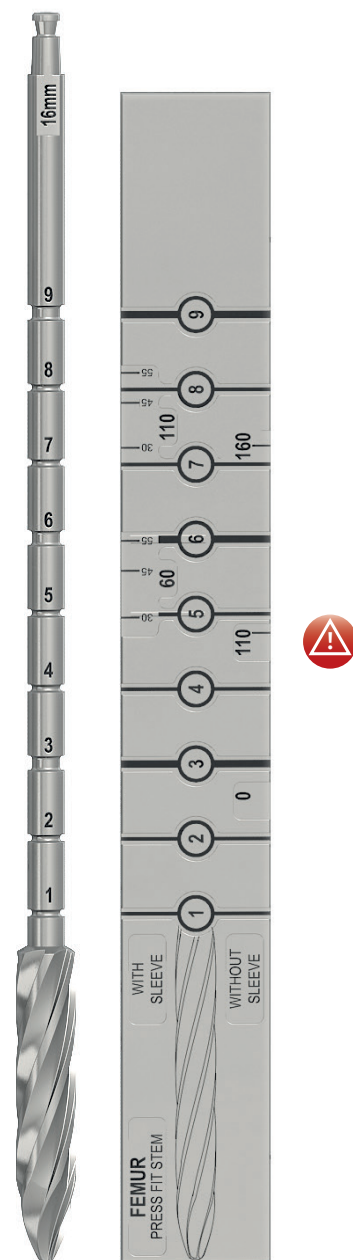

Reference Tool
on Press-Fit Side



CAUTION

Ensure that the Sleeve scale is being referenced. The appropriate ream depth is dependent on the final Sleeve size. If it is not apparent what the final Sleeve size is, ream to the depth corresponding to the largest Sleeve to avoid not having the canal fully prepared.

Canal Reamers

The Canal Reamers come in alternating designs: the odd diameters are fully fluted and the even diameters are stepped down. The even diameter Reamers correspond with definitive Stem Implants (10, 12, 14, 16, 18, 20, 22, 24 mm) and allow the Tibial Cutting Block instruments to be adjusted along the length to set the desired resection height.

The canal may be opened with the fully fluted, end cutting, 9 mm Canal Reamer. 

Canal Preparation

The Canal Reamers have a standard Hudson connection and can attach to the Reamer T-Handle for Hand Reaming or can be used with standard power equipment.

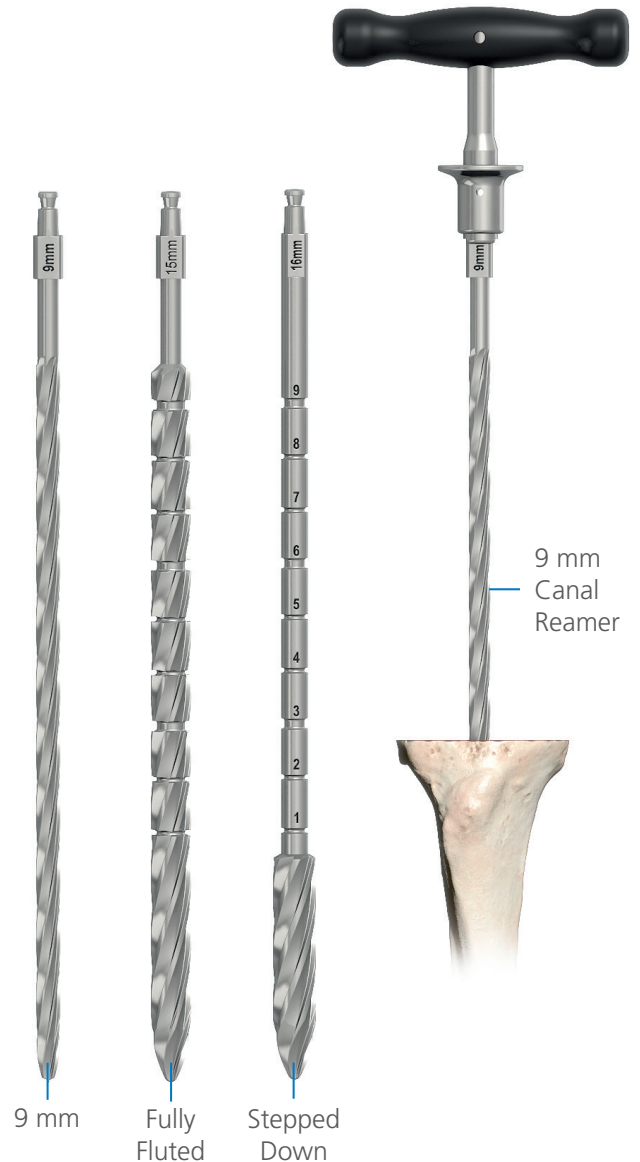

Introduce the Canal Reamer into the canal to the appropriate depth.



CAUTION

The 9 and 10 mm Canal Reamers in the system are end resecting. Be cautious to avoid eccentric reaming or extensive engagement of the cortex.



INFORMATION

Reaming should be done based on bone anatomy and size. Hand reaming is recommended, however, power reaming is available. If power reaming, some tactile feel may be hindered.

Canal Reamers

For Cemented Stem Preparation

Cemented Stems are available in the following sizes:

- 14 mm diameter x 30, 50, 80, 130 mm length
- 16 mm diameter x 80 and 130 mm length

Sequentially open the canal to the same depth with progressively larger Reamers until reaching the 14 mm or 16 mm diameter Reamer for the 14 or 16 mm Cemented Stem respectively to prepare for a line-to-line cement mantle for the shorter stem lengths.

Avoid cortical contact.

The 80 and 130 mm long Cemented Stems are tapered 4 mm diametrically, with the 14 mm diameter Stems tapering to 10 mm and the 16 mm diameter Stems tapering to 12 mm. The line-to-line cement mantle occurs on the parallel section of the stem prior to the taper.



14 x 80 mm
Cemented Stem



16 x 80 mm
Cemented Stem

Canal Reamers

For Press-Fit Stem Preparation

Press-Fit Stems are available in the following sizes:

- 10 - 24 mm diameter (2 mm increments) x 60, 110, 160 mm length

Sequentially open the canal to the same depth with progressively larger Reamers until firm endosteal engagement is established. Remove any native/sclerotic bone at the joint surface that could influence the orientation of the reaming in to the isthmus of the femur or tibia. Canal reaming should end on an even diameter to correspond with the Stem Implant offering. The same diameter final Press-Fit Stem Implant is designed to have a 1.25 mm diametric press-fit with respect to the Reamer.

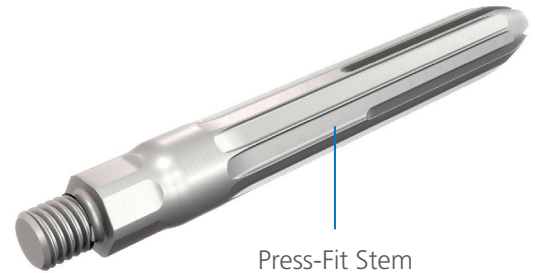

Press-Fit Stem

For Offset Stem Preparation

Sequentially open the canal with progressively larger Reamers to the indicated depth from the Offset Reamer Reference Tool. For a Press-Fit Stem, ream until firm cortical engagement is established. Remove any native/sclerotic bone at the joint surface that could influence the orientation of the reaming in to the isthmus of the femur or tibia. Canal reaming should end on an even diameter Reamer to correspond with the Stem Implant Offering.

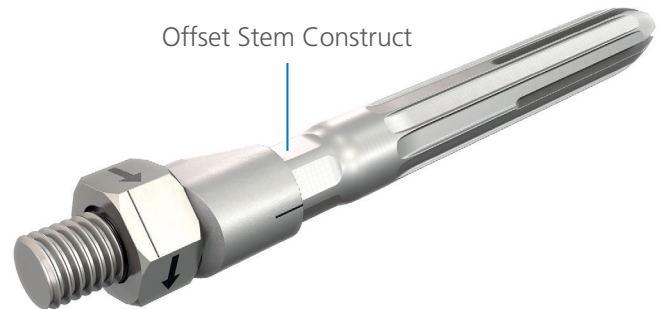

Offset Stem Construct



INFORMATION

Simple cortical contact should not be construed as engagement.

Torque Limiting Screwdriver and System Hex Attachment

The Torque Limiting Screwdriver attaches to the System Hex Attachment *via* an AO connection.



The Torque Limiting Screwdriver Assembly applies a 2 Nm torque to aid in assembly of various instruments throughout the ATTUNE Revision Knee Instrumentation set.

Tighten to “click” when assembling instruments with the Torque Limiting Screwdriver Assembly to ensure solid assembly throughout preparation and trialing.



CAUTION

Not torquing to the “click” may result in trial components loosening during use or extraction.

Modular Stop

The Modular Stop attaches to the Reamers of the Revision System (excluding Canal Reamers) to aid in controlling depth when reaming through a Tower or Bushing.

Slide the Stop over the Hudson end of the Reamer.

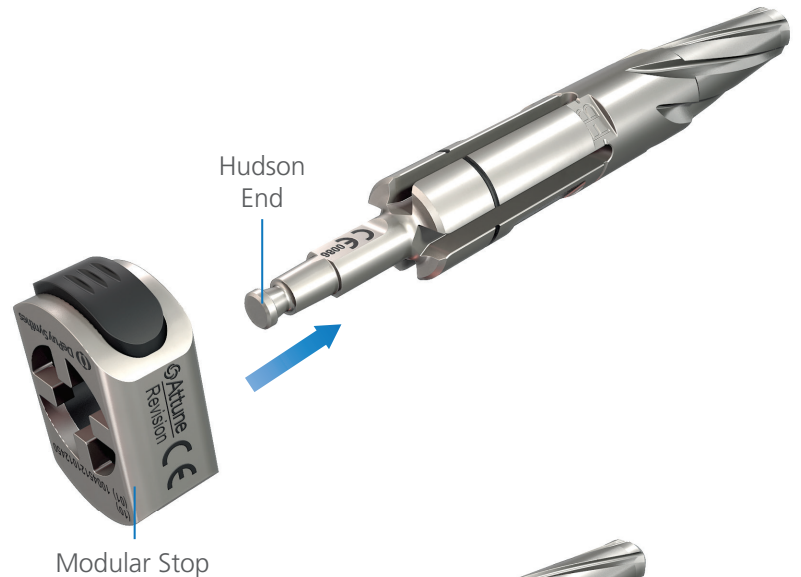

Depress the button on the Modular Stop and place the Stop at the desired preparation indication on the Reamer, where it “clicks” into place. Ensure Modular Stop engages the appropriate groove on the Reamer before use.



Optionally, the Reamers may be utilized through the Towers or Bushings without the Modular Stop. In that application progress the Reamer until the center of the desired depth line is flush with the proximal feature of either the Tower or Bushing.



INFORMATION

Avoid contacting the sharp edges of the Reamer flutes when attaching the Modular Stop.

Stem Trial Assembly

The Stem Trials thread on to their connecting parts.

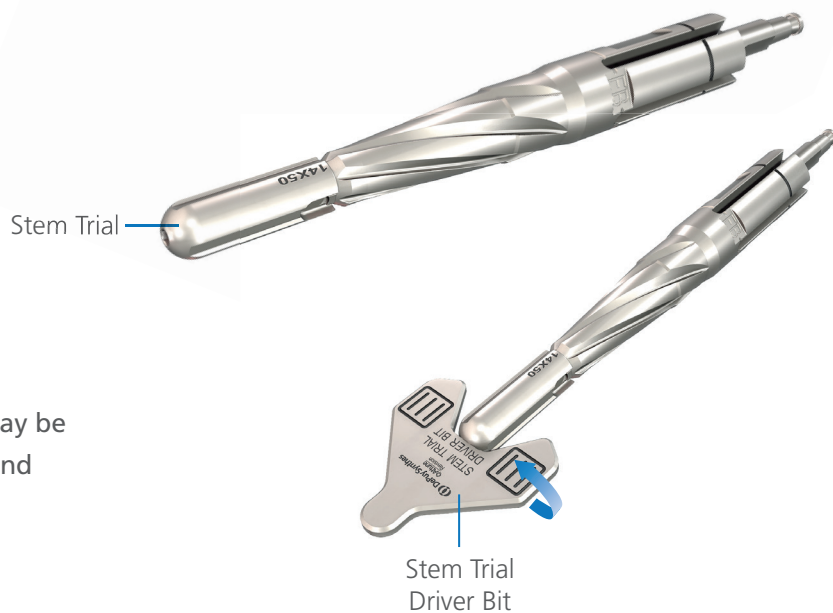

To Aid in Disassembly

If necessary, the Stem Trial Driver Bit may be attached to the end of the Stem Trial and rotated counter clockwise by hand.

Care should be taken not to reverse ream as the Stem Trial may become disengaged from the Reamer. 



CAUTION

Do not reverse ream.

Stem Trial and Stem Stabilizer Extraction

Stem Trial Retrieval

If the Stem Trial disengages from the Reamer, use the female end of the Stem Trial and Stabilizer Extractor Tool to engage the threads of the Stem Trial and extract it from the canal.

The threaded female (hole) end of the Stem Trial and Stabilizer Extractor Tool connects with the threaded male (post) feature on the Stem Trial.



Stem Stabilizer Retrieval

The threaded male (post) end of the Stem Trial and Stabilizer Extractor Tool connects with the threaded female (hole) feature on the Stem Stabilizer.

Drop the appropriate end of the Stem Trial and Stabilizer Extractor Tool into the medullary canal, turn the handle clockwise until a secure engagement is acquired to the Stem Trial or Stem Stabilizer, and pull to extract.

To aid in extraction, there is a through hole in the Stem Trial and Stabilizer Extractor Tool to allow a general surgical instrument, such as forceps, to pass through and create a "T-Handle".

If a stem trial cannot be retrieved utilizing the Stem Trial and Stabilizer Extractor Tool, a designed extraction feature can assist along with a general instrument such as a pituitary rongeur.

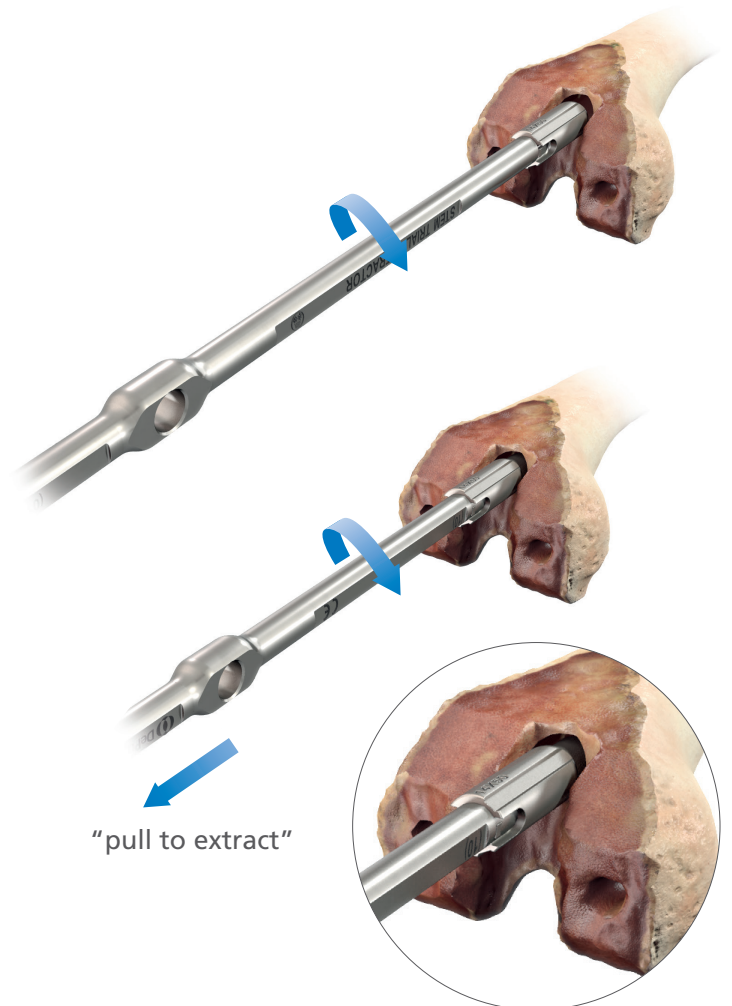

Tibial Trial Assembly

The Revision FB Tibial Base Trial attaches to the FB Adaptor Trial, FB Stem Adaptor Trial, and the FB Offset Adaptor Trials *via* a temporary snap feature.

The FB Adaptor Trial is utilized when the Revision FB Tibial Base will be implanted without the addition of a Stem Extension.

The FB Stem Adaptor Trial is utilized when the Revision FB Tibial Base will be implanted with a Straight Stem Extension.

The FB Offset Adaptor Trial is utilized when the Revision FB Tibial Base will be implanted with an Offset Adaptor and Stem Extension.



The Trial Assembly must be tightened with the Torque Limiting Screwdriver Assembly until it "clicks" prior to handing off the instrument assembly.



Anterior Pins

The Revision Cemented Tibial Prep Plates and Revision FB Base Trials have anterior bump-outs to receive the Anterior Low-Profile Tibial Pins.

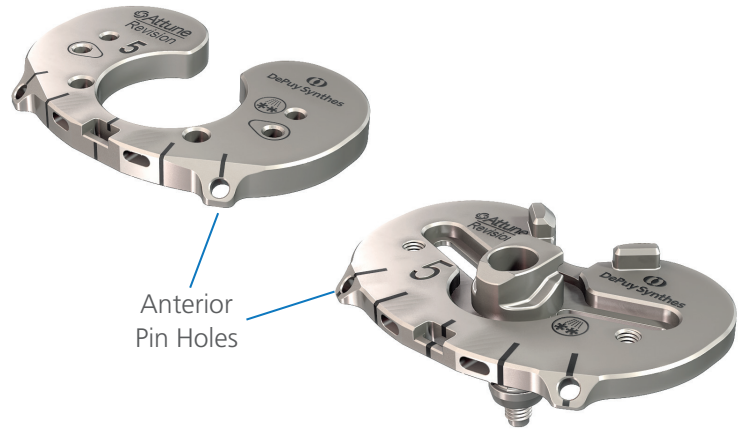

The Anterior Pin Holes are optional and may aid in fixing Tibial Base Rotation.



The Anterior Low-Profile Tibial Pins are inserted and extracted using the Low-Profile Tibial Pin Puller.

The Anterior Pins may be used with the 5 mm Tibial Augment Trial in place, however the 10 and 15 mm Tibial Augment Trials do not have through holes to accept the Pins.



Tibial Preparation - Solutions



Solution 1: Revision Fixed Bearing (FB) Base alone or with Short Cemented Stem Preparation (30 or 50 mm lengths) (Extramedullary Preparation) go to **page 28**



Solution 2: Revision Fixed Bearing (FB) Base with Straight Stem or Offset Stem Preparation (Intramedullary Preparation) go to **page 40**



Straight Stem



Offset Stem



Tibial Preparation

Tibial Alignment and Resection - Instrument Assembly

This is the Extramedullary Tibial Preparation of the Revision Fixed Bearing (FB) Tibial Base, alone (with the pre-assembled End Cap) or with a 30 or 50 mm Cemented Stem.

With the Height Adjustment Knob fully unscrewed on the Tibial Proximal Uprod, attach the Tibial Distal Uprod to the Proximal Uprod. Then attach the Tibial Ankle Clamp to the Distal Uprod. Assemble the appropriate Cutting Block to the Tibial Proximal Uprod.

Revision Tibial Cutting Block Options

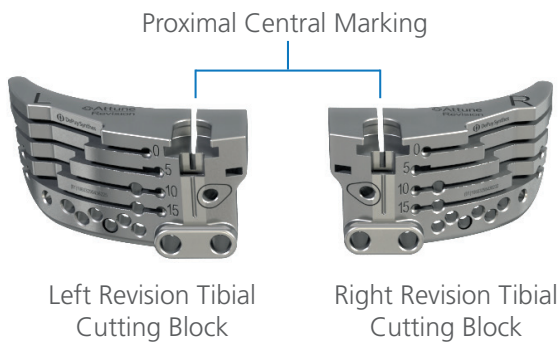

Tibial Jig Assembly



Complete Assembly



Tibial Preparation

Tibial Alignment and Resection



Set the tibial posterior slope as depicted on the Proximal Uprod of the Tibial Jig, according to the recommendations depending on the appropriate implant configuration.

Place the knee in 90 degrees of flexion. Place the Ankle Clamp around the malleoli. Set Varus/Valgus (V/V) rotation by aligning the proximal central marking on the Tibial Cutting Block with the medial one third of the tibial tubercle.

The axis of the Proximal Uprod should be positioned with reference to the tibial axis.

Note that the figures on the Jig will only deliver that angle if the rest of the Jig is set up correctly. If the slope adjustment is changed after the Cutting Block is resting against bone, the surgeon should re-align the Uprod to be parallel to the tibial axis by moving the A/P adjustment mechanism.



Correct Placement of Tibial Jig

i INFORMATION

Tibia Slope Recommendations: Revision Tibial Base constructs will follow the Posterior Stabilized (PS) Slope recommendation. The Revision Tibial Bases have a 2 degree posterior slope of the Stem with respect to the tibial plateau. For a PS configuration it is recommended to set the tibial posterior slope at 3 degrees.

When using Cruciate Retaining or Cruciate Sacrificing (CRICS) configuration, with the ATTUNE CR Tibial Insert and the ATTUNE CR Femoral Component, it is recommended to use 5 - 7 degrees of tibial posterior slope. Surgeons should pre-operatively template a stemmed tibial construct when using a CRICS configuration to assess the impact of slope upon Stem orientation and fit within the canal.

i INFORMATION

The Revision Tibial Cutting Blocks slot are set at 0 degrees similar to the ATTUNE Primary Knee INTUITION™ Tibial Cutting Block, the slope is adjusted through the Extramedullary Tibial Proximal Uprod.

Tibial Preparation

When checking and setting the sagittal alignment, be careful to prevent anterior slope. This could happen if the A/P Boss on the Distal Uprod is translated too far towards the ankle, exposing the Through-Slot. Posterior slope adjustment is the equivalent to using Cutting Blocks with slope built into them.

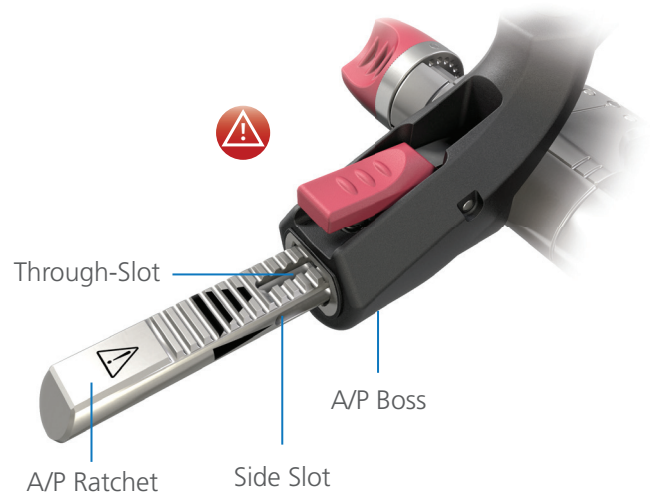

Use the V/V Adjustment Mechanism to align the Tibial Proximal Uprod parallel to the long axis of the tibia. For many patients, this involves translating the V/V Adjustment Mechanism until the second line from the lateral side of the ankle clamp lines up with the indicator line.

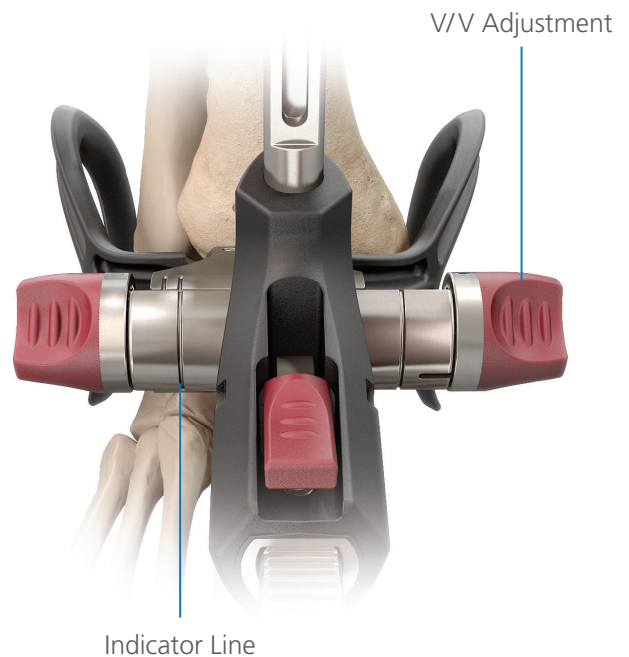

Stylus Attachment

Attach the Adjustable Tibial Stylus to the Cutting Block through the slot feature.

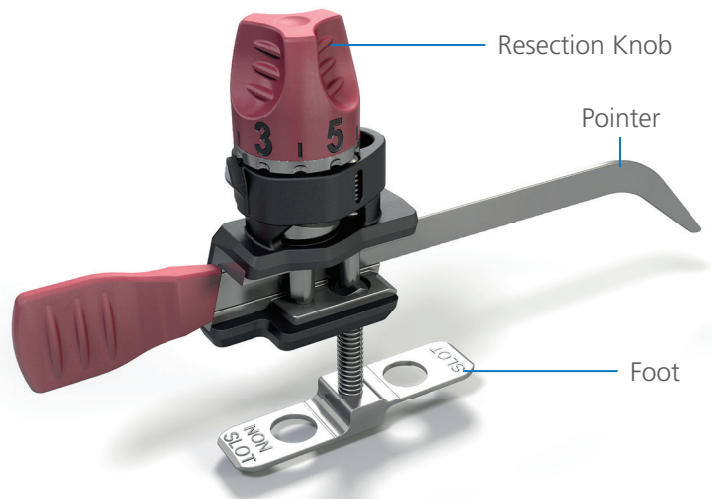

CAUTION

Adjustment of the A/P Boss such that the Through-Slot is visible (as shown) could result in anterior slope.

Tibial Preparation

Resection through the Slot

When utilizing the Revision Tibial Cutting Block, **resection through the slot is recommended.** Position the foot of the Stylus marked "SLOT" into the "0" slot of the Cutting Block.

Rotate the Resection Knob to set the resection level on the Stylus (0 to 10). Each number corresponds to resection amount in millimeters.

For resection off the top of the block, see the **CAUTION** box below for the Stylus. 

Rest the pointer of the Adjustable Tibial Stylus on the bone according to the presented tibial plateau.

Considerations for tibial plateau resections:

- If a defect is present, the Adjustable Tibial Stylus may be used to reference the defect and provide a minimal resection to clean up a revision tibial plateau, with the option of augmenting where required
- For a **Revision Tibial Plateau**, use the Revision Tibial Cutting Blocks with a minimal resection, with the option of resecting for augments where required

Then lock the Height Adjustment Knob on the Proximal Uprod.

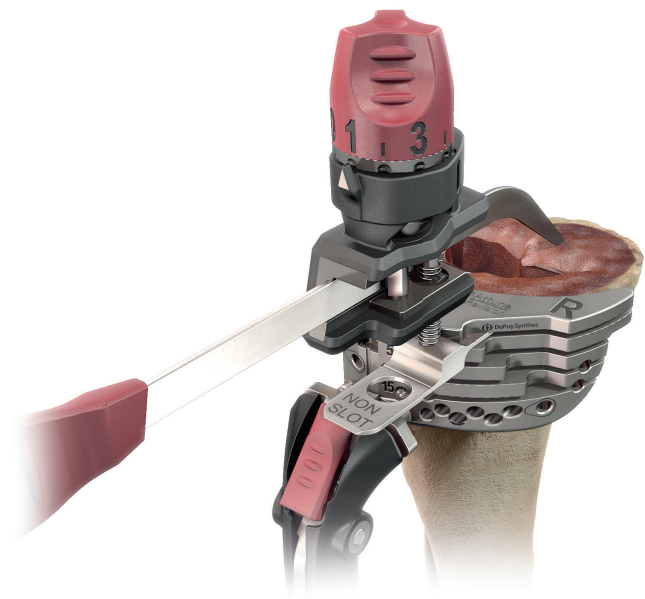

CAUTION

If resection off the top of the Revision Tibial Cutting Block is desired, and the "NON SLOT" setting on the Stylus is used, the resection will be 1 mm less than indicated with the Stylus due to the saw capture of the Revision Tibial Cutting Block being 5 mm vs 4 mm in the INTUITION Instrument set. The subsequent Augment Slots will be 5 mm deeper than indicated by the marking on the Block.

Tibial Preparation

Proximal Tibial Resection

After the height has been set, pin the Revision Tibial Cutting Block using two Universal Pins.

If necessary, remove the Stylus for better access, ensuring that the Height Adjustment Knob on the Tibial Proximal Uprod is locked.

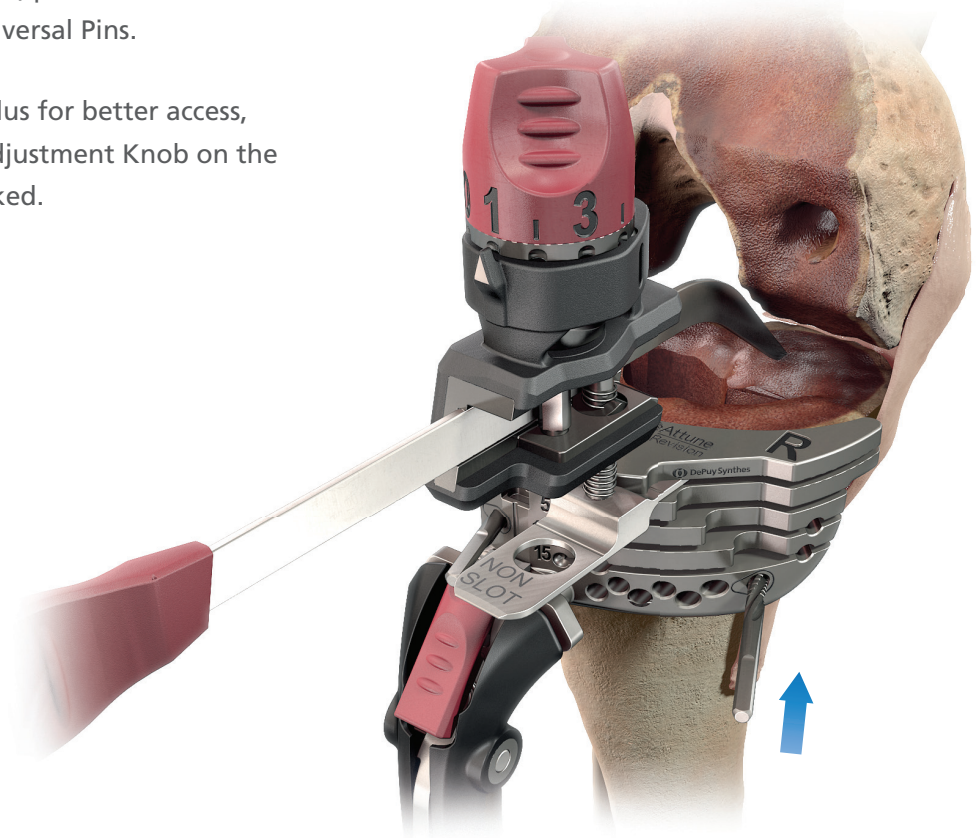

There are multiple Pin hole options in the Revision Tibial Cutting Block to ensure fixation of the Block.

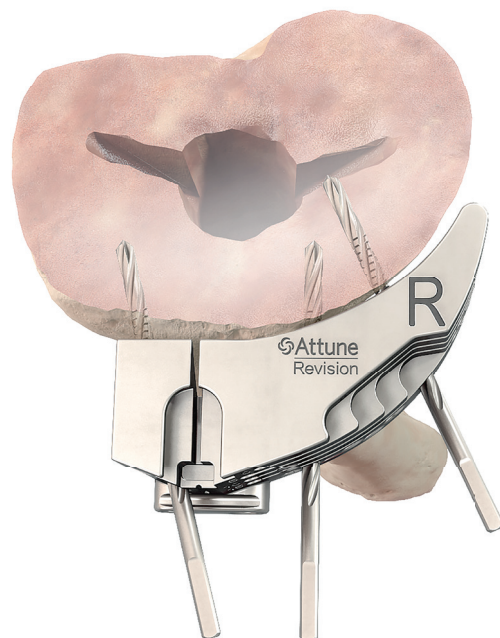

Tibial Preparation

Optional: To assess tibial slope prior to performing the tibial resection, place the Alignment Handle into the slot feature of the Revision Tibial Cutting Block, and insert the Alignment Rod. Alignment can be checked by ensuring that the Alignment Rod remains parallel with the tibial axis.

Additionally, the two Alignment Rods may be assembled with the Alignment Handle to assess long leg alignment from hip center to ankle.

A second Alignment Rod may be inserted through the Alignment Handle in the M/L direction to help ensure that the tibia is not resected in Varus or Valgus.

Resect the tibia.

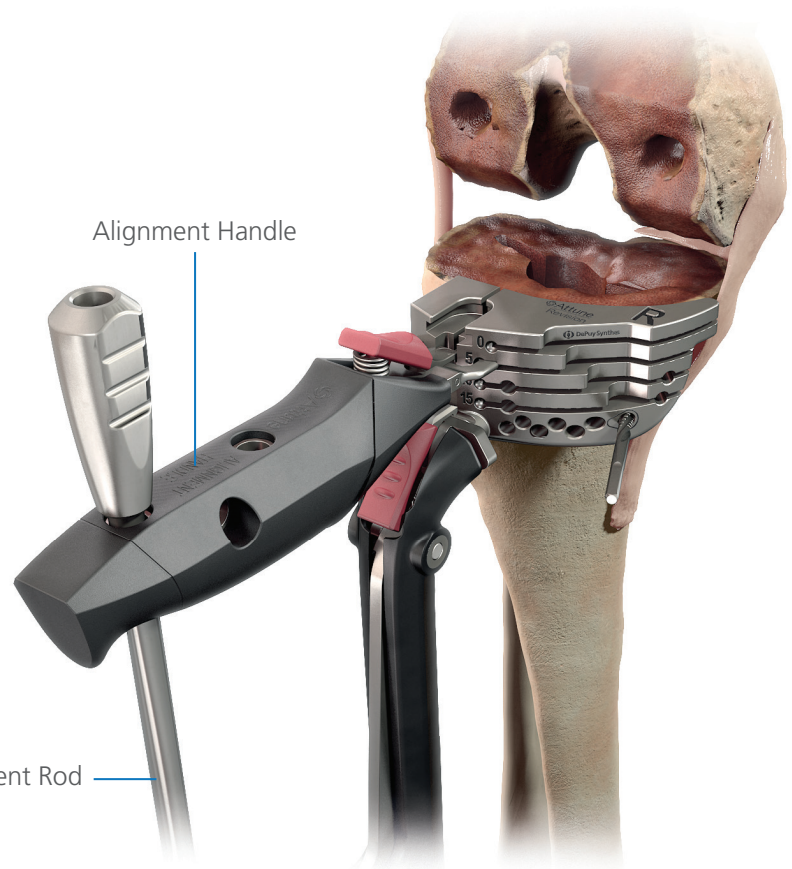

If desired, Medial Augments may be prepared at this point.

Should Lateral Augments be required, if exposure permits, utilize the Tibial Cutting Block for the opposite leg.

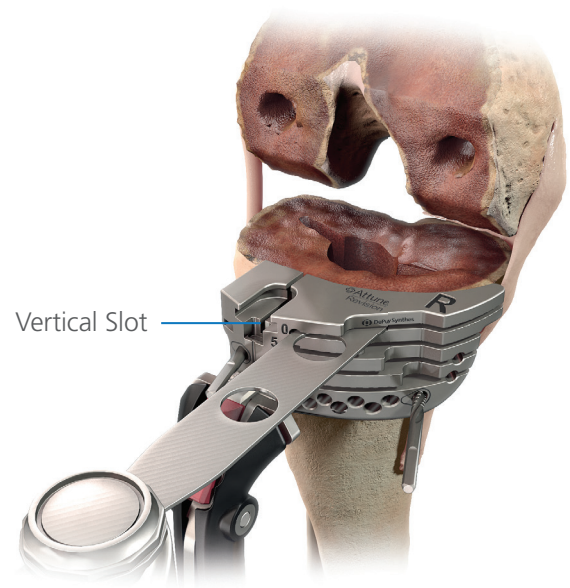

INFORMATION

The vertical slot in the central aspect of the Tibial Cutting Block may aid in initiating the center line of the Tibial Augment resection.

Tibial Preparation

Tibial Sizing

Attach the Alignment Handle to the appropriate size Revision Tibial Prep Plate based on pre-operative templating and place onto the resected tibial surface.

Rotation should be set per surgeon preference. One suggested technique follows:

The rotation of the Tibial Base Trial is typically centered on the junction between the medial and central third of the tibial tubercle. Assess the position of the Base at the proper rotation to maximize tibial coverage while avoiding overhang. Optionally, a mark may be made on the anterior cortex of the tibia for future reference to tibial rotation.

When using Pins, be careful not to deflect the Base position. 

Only utilize Non-Headed Pins through the parallel or angled Pin Hole options on the Prep Plate.

Additionally, the Anterior Pin Holes may be utilized with the Low Profile Anterior Pins inserted with the Low Profile Tibial Pin Puller to aid in fixating the Prep Plate.

Tibial Prep Plates for Sizes 1 - 3 have an anterior protrusion with an indicated line for the anterior profile of the definitive implant.

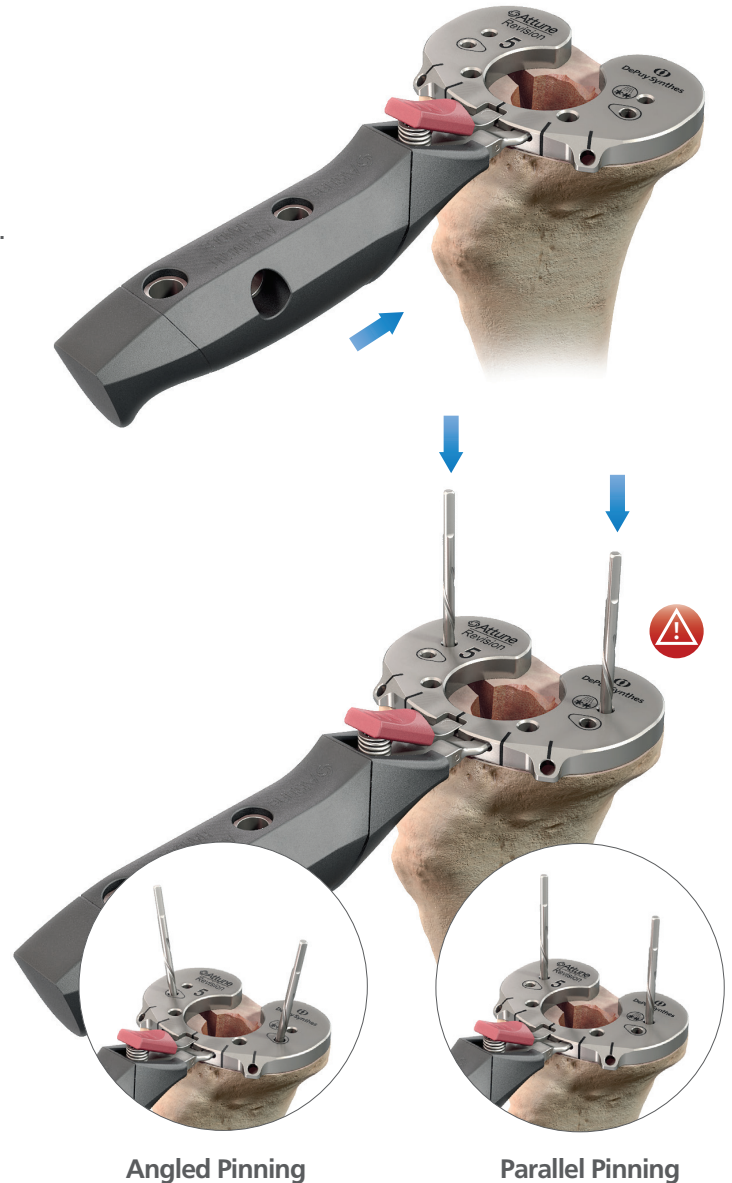

Example of anterior protrusion for Sizes 1 - 3

CAUTION

Care should be taken when seating the Pins so as to not perforate the Tibial Cortex.

INFORMATION

Final Tibial Base Rotation can also be determined during trialing with the Femoral Trial and Revision Tibial Insert Trial in place. Refer to **page 151**.

INFORMATION

The Revision Tibial Prep Plates are 6 mm thick and are not reflective of the actual Tibial Base Implant or Tibial Base Trial thicknesses. The Prep Plates should not be utilized to determine definitive Insert thickness.

Tibial Preparation

With the Revision Tibial Prep Plate in place, attach the Revision Tibial Prep Tower by inserting the spikes of the Tower through the two inside holes on the anterior aspect of the Plate.

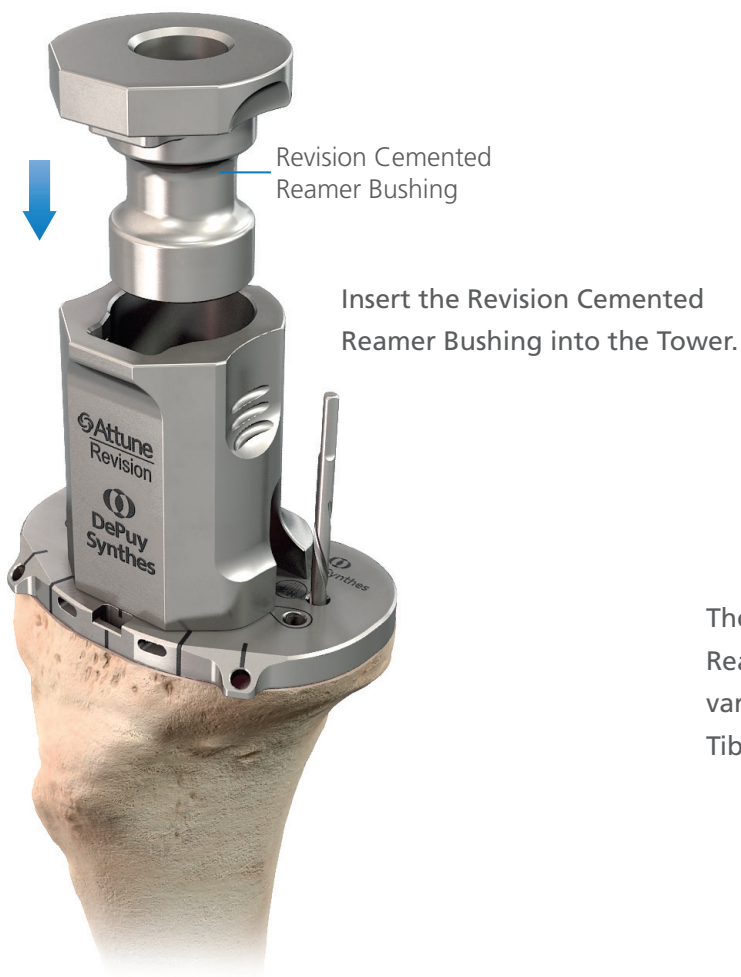

The Revision Tibial Cmented Stem Reamer includes markings for the various Short Cmented Stems and Tibial Base construct depths.



i INFORMATION

The Tibial Cmented Stem Reamer prepares for a line-to-line fit with the pre-assembled End Cap or the short (30 mm and 50 mm) Cmented Stem Implants.

Tibial Preparation

Assemble the Modular Stop to align with the desired FB construct depth on the Revision Tibial Cemented Stem Reamer and advance the Reamer until the Stop is flush with the top of the Reamer Bushing.

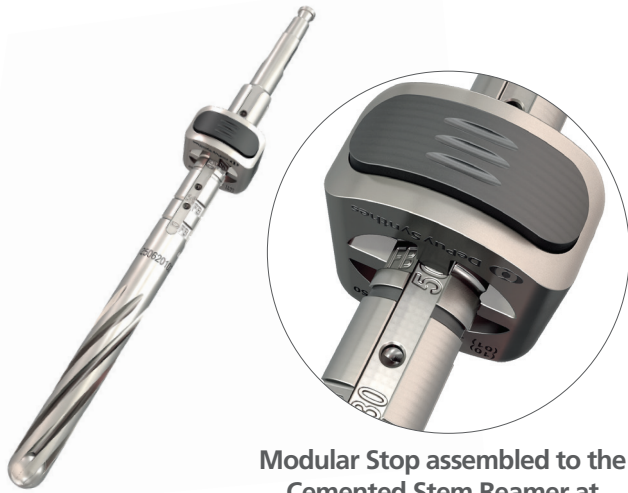

Modular Stop assembled to the Cemented Stem Reamer at the FB with 50 mm Stem mark

The Cemented Stem Reamer may be utilized through the Reamer Bushing without the Modular Stop. In that application, progress the Reamer until the desired depth line is flush with the proximal feature of the Reamer Bushing.

Remove the Cemented Stem Reamer and Cemented Reamer Bushing.



INFORMATION

If preparing for a Revision FB Tibial Base without a Stem Extension, ream to the "FB-0" mark on the Cemented Stem Reamer to prepare for the End Cap on the Tibial Implant.

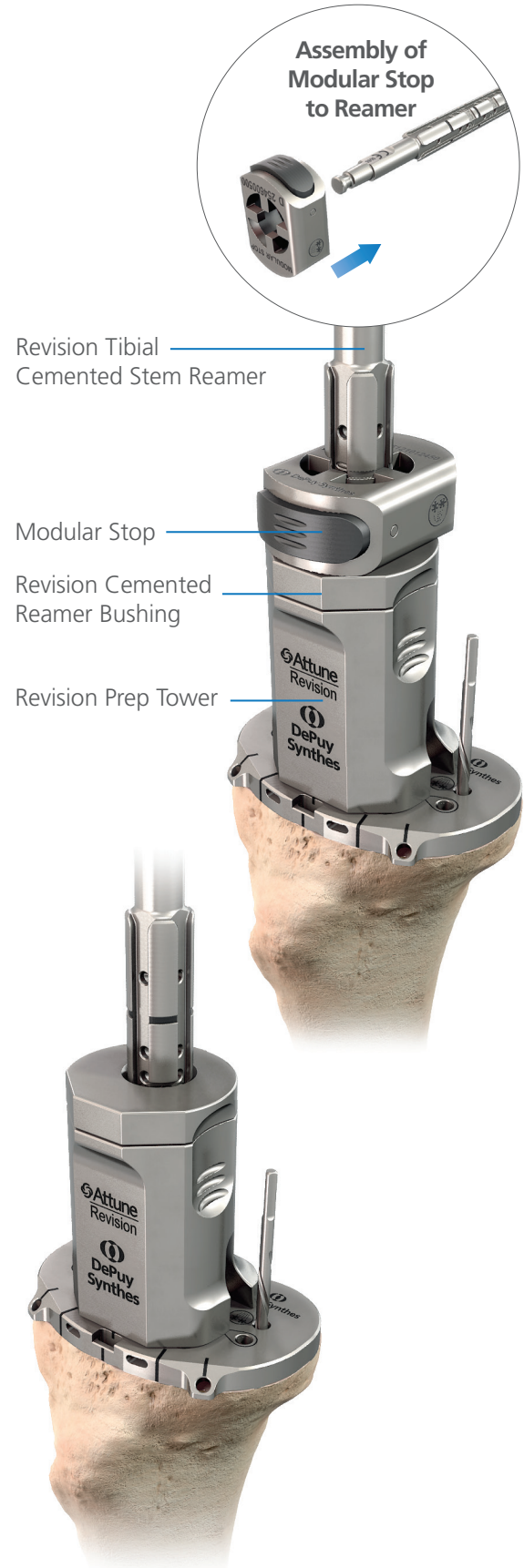

Tibial Preparation

Assemble the corresponding Stem Trial to the end of the Revision Cemented Conical Reamer. If preparing for a Revision Base without a Stem Extension utilize the Conical Reamer without any Stem Trials.

Assemble the Modular Stop to align with the "FB" line on the Revision Cemented Conical Reamer.



To prepare for the conical section of the Tibial Base, advance the Conical Reamer through the Tower and seat to the Stop. The Conical Reamer can be used without the Modular Stop. In that application, progress the reamer until the "FB" line on the Reamer is flush with the proximal surface of the Revision Prep Tower. 

With the tibial canal prepared, remove the Tibial Preparation Instruments.



CAUTION

Avoid contacting the sharp edges of the Reamer flutes when attaching the Modular Stop.

Do not reverse ream.



INFORMATION

Do not apply excessive force to the Conical Reamer. If approaching the cortex, stop reaming and consider a slightly different position on the tibial plateau, readjustment of tibial slope and the use of cement to fill any resulting bone voids.

Tibial Preparation

Straight Tibial Trial Assembly

Choose the appropriate size of FB Base Trial that corresponds to the Tibial Preparation Plate and assemble the FB Stem Adaptor Trial utilizing the temporary snap attachment.



Tighten the construct using the Torque Limiting Screwdriver Assembly.

FB Base Trial construct with a 14 x 50 mm Cemented Stem Trial



Assemble the Cemented Stem Trial to the end of the FB Stem Adaptor Trial.



FB Base Trial with FB Adaptor Trial

If preparing for a Revision FB Tibial Base without a Stem Extension, assemble the FB Adaptor Trial to the appropriate FB Base Trial and tighten the construct with the Torque Limiting Screwdriver Assembly.



INFORMATION

The FB Adaptor Trial is utilized when the Revision FB Tibial Base will be implanted without the addition of a Stem Extension.

Tibial Preparation

Seat the Tibial Base Trial construct into the prepared bone using the Revision System Handle attached directly to the FB Base Trial.

Proceed to **Revision Femoral Preparation** on page 54 prior to setting the final FB Tibial Base Rotation and preparing for the Keels.

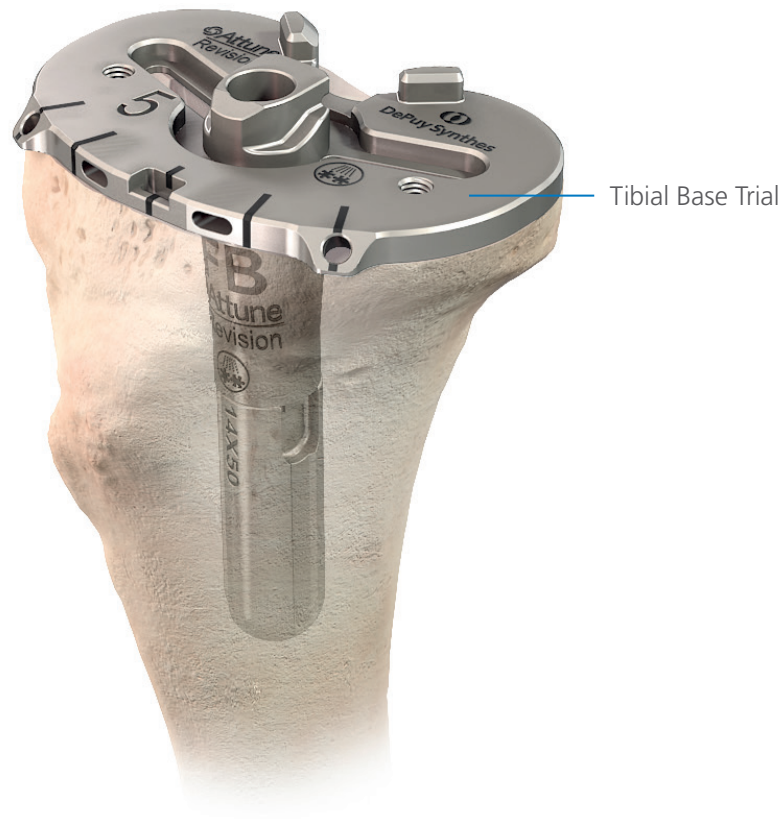

Tibial Preparation

Canal Preparation

This is the Intramedullary Tibial Preparation of the Revision FB Tibial Base, with the following Stems:

- Cemented Stem: 80 or 130 mm lengths,
- Press-Fit Stems: 60, 110, 160 mm lengths,
- Offset Adaptor with a Press-Fit Stem.

When pre-operative evaluation indicates that Press-Fit or Long (>50 mm) Cemented Tibial Stem Extensions are required, it is recommended to prepare the proximal tibia with reference to the position of the IM canal.



Straight Stem

Utilize the Tibial Reamer Reference Tool. Refer to **pages 15 - 17**.



Offset Stem

Utilize the Tibial side of the Offset Reamer Reference Tool. Refer to **pages 15 - 17**.

Assemble the Canal Reamer to either the Reamer T-Handle or standard power. Sequentially straight canal ream to the appropriate depth and diameter and leave the Reamer in place, remembering to finish on an even diameter Reamer, refer to **pages 18 - 20**.



Tibial Preparation



Straight Stem



Offset Stem

Select the appropriate sided Block, and assemble the Cutting Block Mount to the Revision Tibial Cutting Block.

Cutting Block Mount

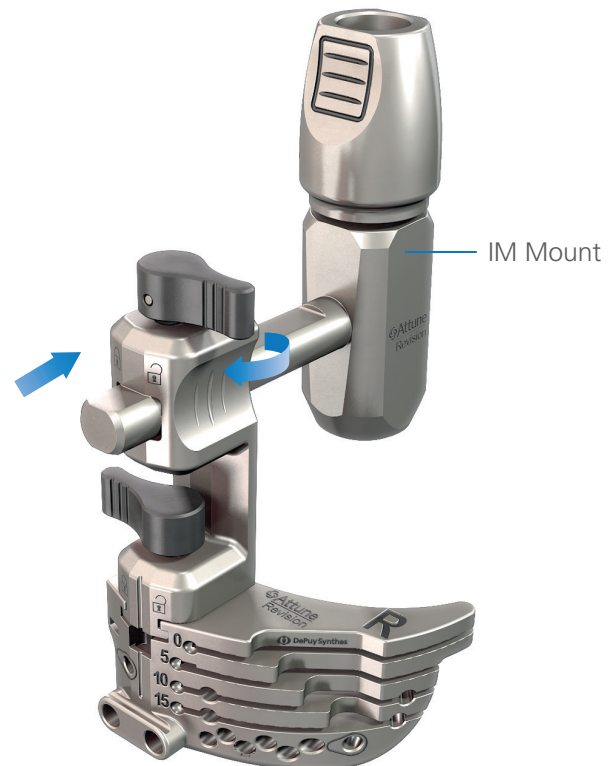
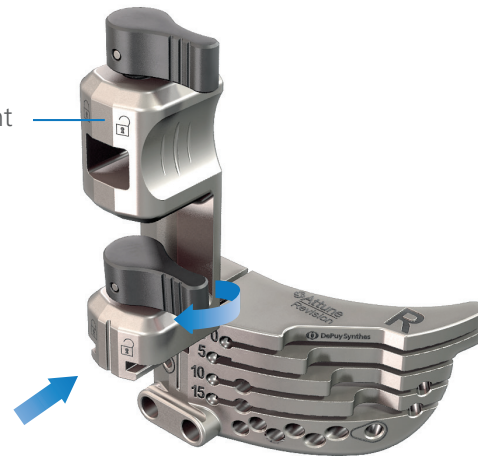

Assemble to the IM Mount.

Tibial Preparation



Straight Stem



Offset Stem

Assemble the Revision IM Mount to the Canal Reamer.

Adjust the Tibial Cutting Block Assembly to the desired level of proximal tibial resection.

An Angel Wing, or the “Slot” Foot of the ATTUNE Primary INTUITION Tibial Stylus may be used to assist with setting depth. 

Lock the Jig in place by tightening the Lock Knob over the IM Mount.

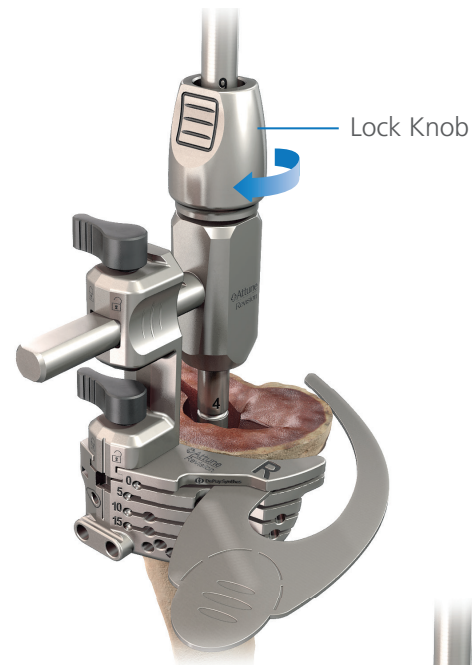

Angel Wing



Stylus with Slot Foot



CAUTION

If resection off the top of the Revision Tibial Cutting Block is desired, and the “NON SLOT” setting on the Stylus is used, the resection will be 1 mm less than indicated with the Stylus due to the saw capture of the Revision Tibial Cutting Block being 5 mm vs 4 mm in Primary Tibial Cutting Block. The subsequent Augment Slots will be 5 mm deeper than indicated by the marking on the Block.



INFORMATION

The Revision Tibial Bases have a 2 degree posterior slope of the Stem with respect to the tibial plateau.

The 2 degree posterior resection is built into the IM Mount and will provide a fixed angle of resection when assembled to the Intramedullary based Canal Reamers.

Tibial Preparation

Tibial Resection



Straight Stem



Offset Stem

Pin the Tibial Cutting Block.



Make tibial resection.

If desired, Medial Augments may be prepared at this point.

Should Lateral Augments be required, if exposure permits, utilize the Tibial Cutting Block for the opposite leg.

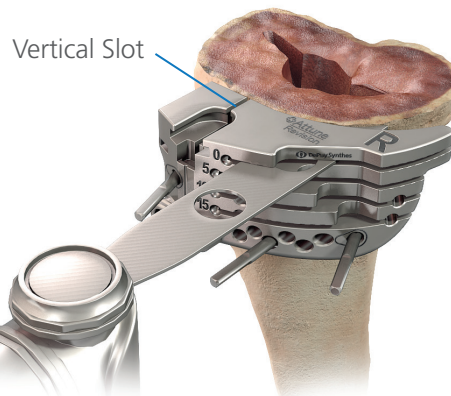

Remove Tibial Cutting Block and Pins
(and other tibial instruments).



INFORMATION

The Canal Reamer and Tibial Jig Assembly may be removed from the canal in order to complete the tibial resection. To do so, move both levers on the Cutting Block Mount to the unlock  position, slide the Cutting Block Mount anteriorly and then remove the assembly proximally while leaving the Cutting Block pinned in place.



INFORMATION

The vertical slot in the central aspect of the Tibial Cutting Block may aid in initiating the center line of the Tibial Augment resection.

Tibial Preparation



Straight Stem



Offset Stem

Attach the Alignment Handle to the appropriate size Revision Tibial Prep Plate and place onto the resected tibial surface.

Rotation should be set per surgeon preference. One suggested technique follows:

The rotation of the Tibial Base Trial is typically centered on the junction between the medial and central third of the tibial tubercle. Assess the position of the Base at the proper rotation to maximize tibial coverage while avoiding overhang. Optionally, a mark may be made on the anterior cortex of the tibia for future reference to tibial rotation.



Tibial Prep Plates for Sizes 1 - 3 have an anterior protrusion with an indicated line for the anterior profile of the definitive implant.

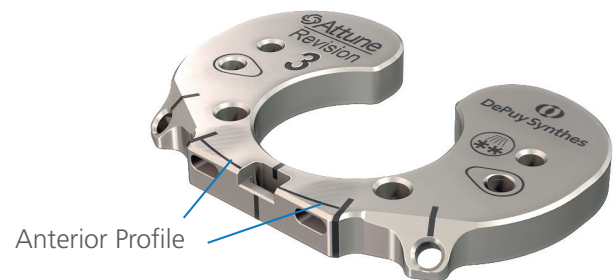

Example of anterior protrusion for Sizes 1 - 3



INFORMATION

*Final Tibial Base Rotation can also be determined during trialing with the Femoral Trial and Revision Tibial Insert Trial in place. Refer to **page 151**.*



INFORMATION

The Revision Tibial Prep Plates are 6 mm thick and are not reflective of the actual Tibial Base Implant or Tibial Base Trial thicknesses. The Prep Plates should not be utilized to determine definitive Insert thickness.

Tibial Preparation

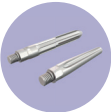

Straight Stem



Offset Stem

If required, reintroduce the final Canal Reamer to the previously prepared depth.

Introduce the Revision Tibial Prep Plate over the Canal Reamer.

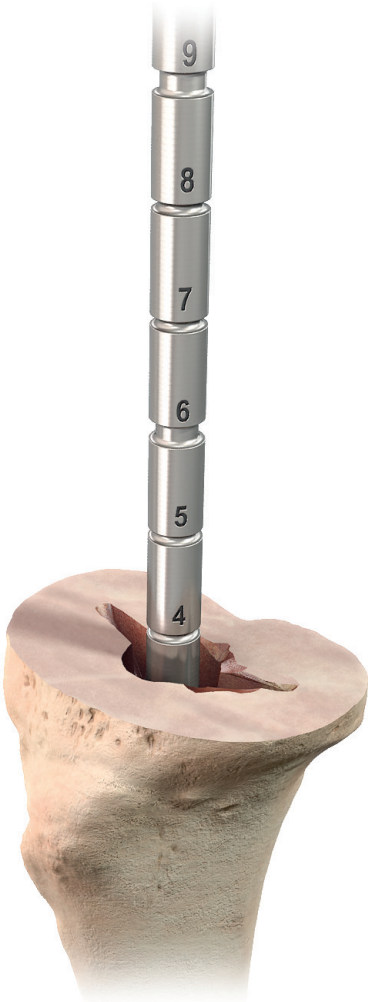

Tibial Preparation



Straight Stem



Offset Stem

Perform a preliminary assessment of canal position with a Neutral (0 mm) Offset Guide.

If desired rotation and coverage is achieved with Neutral position, proceed to the next page. If not the following strategies could be used:



Straight Stem



Offset Stem

- Reassess Tibial sizing

- Evaluate the 2, 4, 6 mm offset positions via the corresponding Tibial Offset Guides

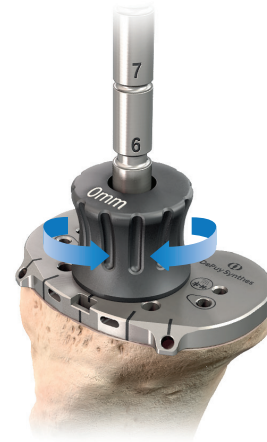

For Straight Stem preparation, proceed to page 47.

For Offset Stem preparation, proceed to page 48.

i INFORMATION

The Neutral (0 mm) Tibial Offset Guide is equivalent to using a Straight Stem and is available for initial Canal-to-Plateau assessment. There is no 0 mm Offset Adaptor Implant. If this 0 mm provides better coverage, proceed with Straight Stem preparation.

i INFORMATION

The Offset Adaptor extends the length of the construct by 25 mm which should be considered when addressing anatomy with significant bow.

Tibial Preparation

Straight Canal Preparation



Straight Stem

Attach the appropriately sized Stem Trial to the FB Conical Reamer.



Ream the tibia until the top of the Reamer flutes are level with proximal tibial plateau.



For Straight Tibial Trial Assembly, proceed to **page 52**.

Top of the Reamer Flutes

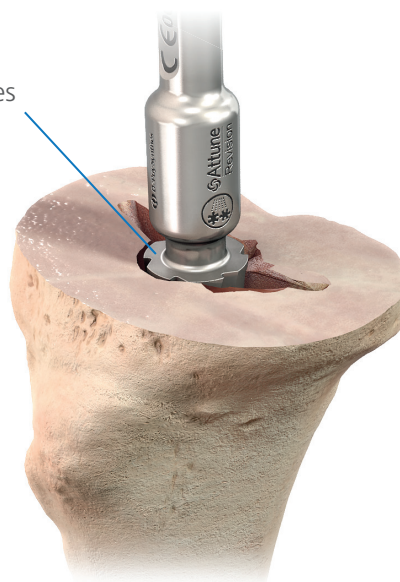

CAUTION

Do not reverse ream.

Tibial Preparation

Offset Base Preparation



Offset Stem

Once the desired offset amount and orientation is determined, pin the Tibial Prep Plate in place through the Parallel Pin Holes.

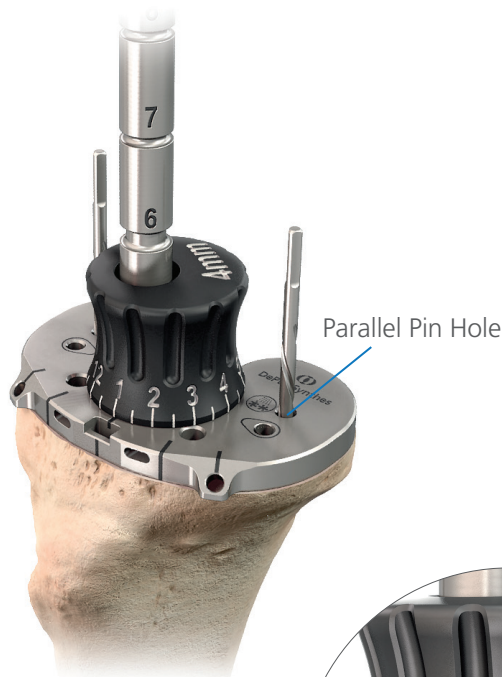

Note the number value aligned with the front, central mark on the Tibial Prep Plate, this is what will be used to set the initial Trial orientation.

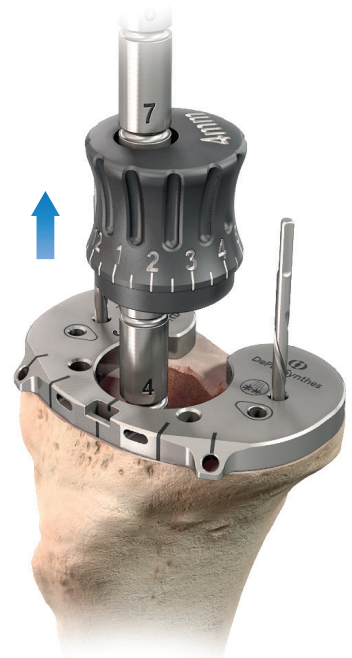
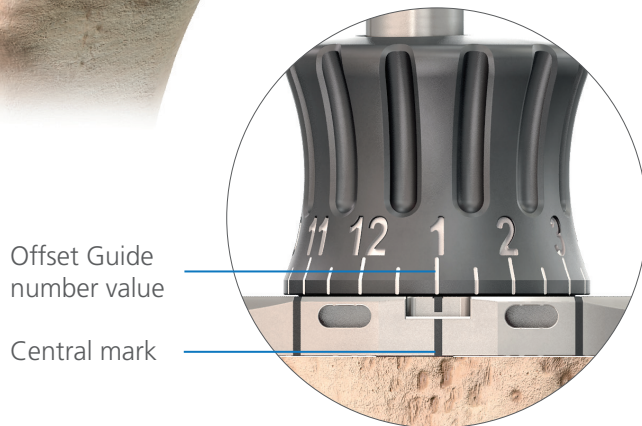

Remove the Tibial Offset Guide.

Tibial Preparation

Offset Base Preparation



Offset Stem

Translate the Tibial Prep Plate vertically along the Parallel Pins, remove the Canal Reamer, and reintroduce the Tibial Prep Plate onto proximal tibia *via* the Parallel Pins.

If Pins become dislodged from the tibia when extracting the Prep Plate, reintroduce them to their original position prior to reintroducing the Tibial Prep Plate to ensure proper placement of the Prep Plate for subsequent surgical steps.

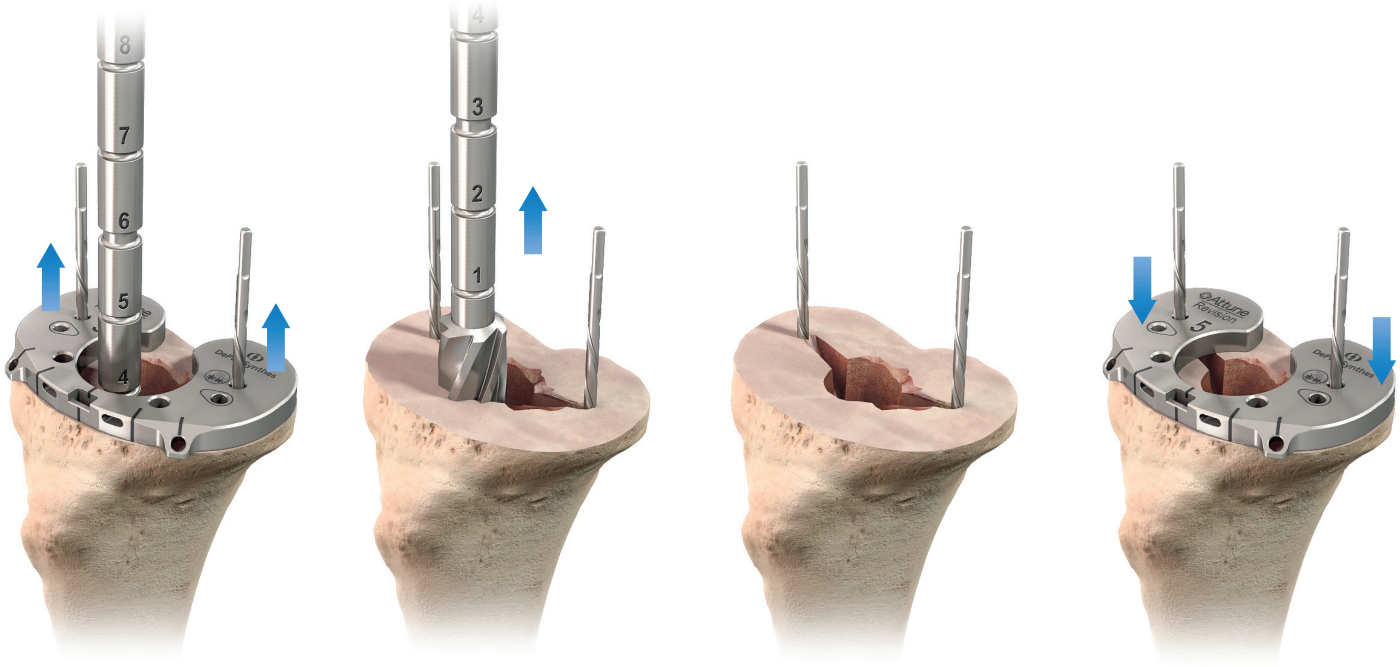

i INFORMATION

For smaller magnitude offsets and/or smaller diameter Canal Reamers, the Canal Reamer may be extracted from the tibia without first having to remove the Tibial Prep Plate.

Tibial Preparation

Offset Base Preparation



Offset Stem

Next, locate the spikes of the Revision Tibial Prep Tower in the anterior holes of the Prep Plate and seat the Tower until it is flush with the Prep Plate.

Tibial Prep Tower



Tibial Prep Tower
Offset Bushing



Assemble the Tibial Prep Tower Offset Bushing to the Tower.

Tibial Preparation

Offset Base Preparation



Offset Stem

Assemble the Modular Stop to the TIB marking on the Offset Drill.

Introduce the Offset Drill to the Offset Bushing and seat the Drill to the TIB marking or when the Stop is flush with the proximal aspect of the Offset Bushing.

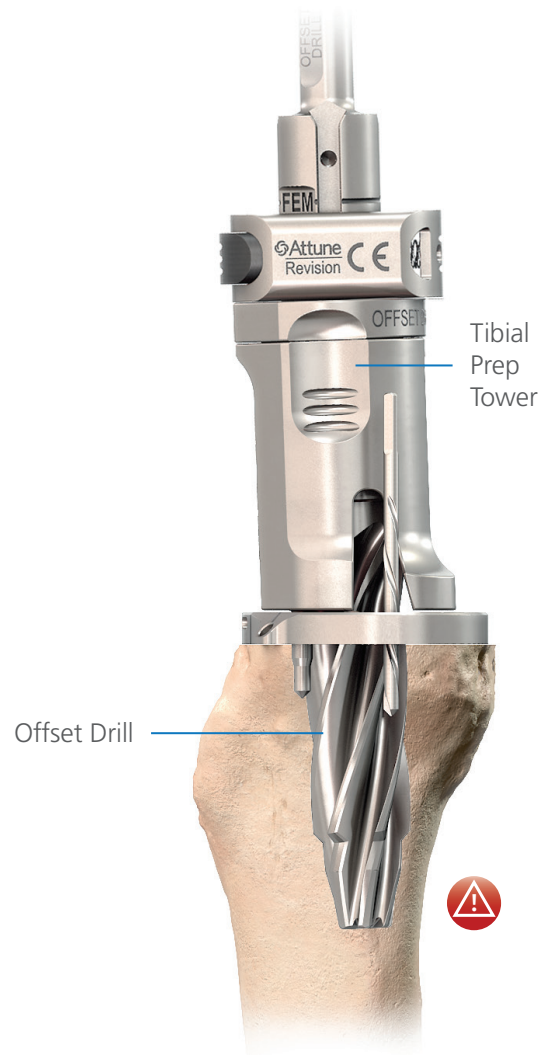
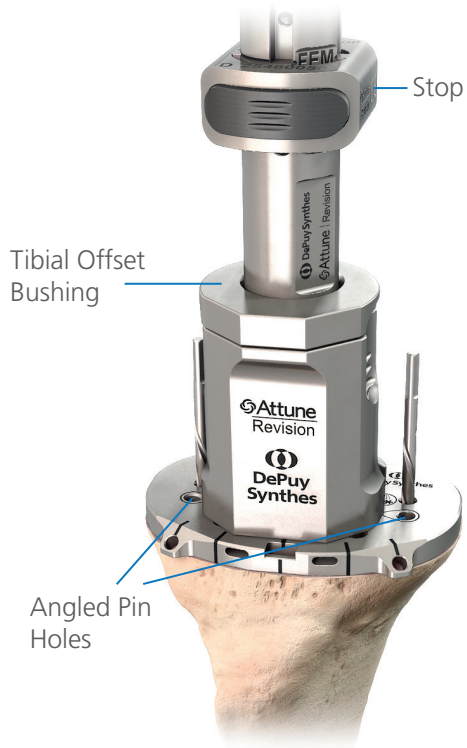

For Offset Tibial Trial Assembly, proceed to **page 52**.



INFORMATION

Angled Pin Holes are available in the Prep Plate for added stability. Utilize the Angled Pin Holes after the Canal Reamer has been removed from the tibia.



CAUTION

If cortex is reached when advancing the Offset Drill, stop drilling to avoid cortical perforation, and reassess the required offset magnitude and/or rotation, or consider the use of a Straight Stem.

Tibial Preparation



Straight Stem

Assemble the FB Base Trial with the FB Stem Adaptor and appropriate Stem Trial.



Offset Stem

Assemble the FB Base Trial with the appropriate magnitude Tibial Offset Adaptor Trial (2, 4, or 6 mm).

To set the preliminary offset orientation, rotate the Tibial Offset Adaptor Trial to the offset orientation noted from the Tibial Offset Guide.

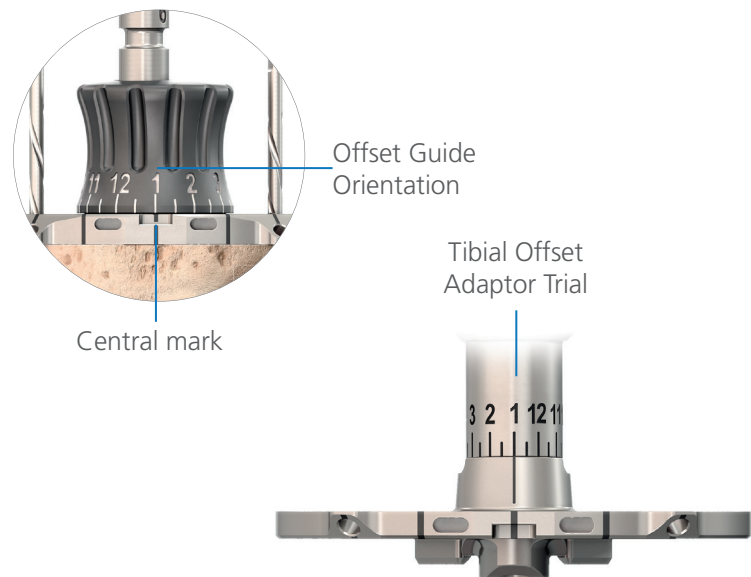

Lock the preliminary orientation using the Torque Limiting Screwdriver Assembly.

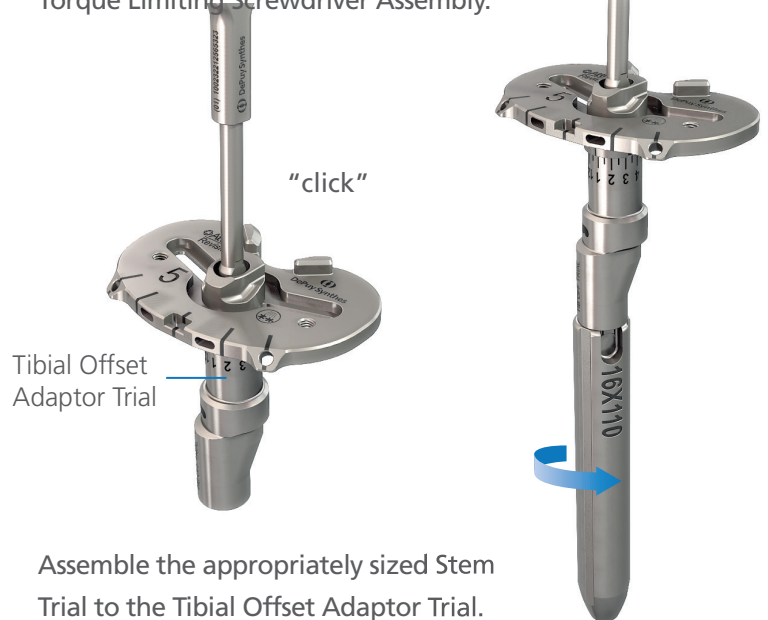

Assemble the appropriately sized Stem Trial to the Tibial Offset Adaptor Trial.

Tibial Preparation



Straight Stem



Offset Stem

Seat the Tibial Base Trial construct into the prepared bone using the Revision System Handle attached directly to the FB Base Trial.

Proceed to **Revision Femoral Preparation** on page 54 prior to setting final FB Tibial Base Rotation and preparing for the Keel.

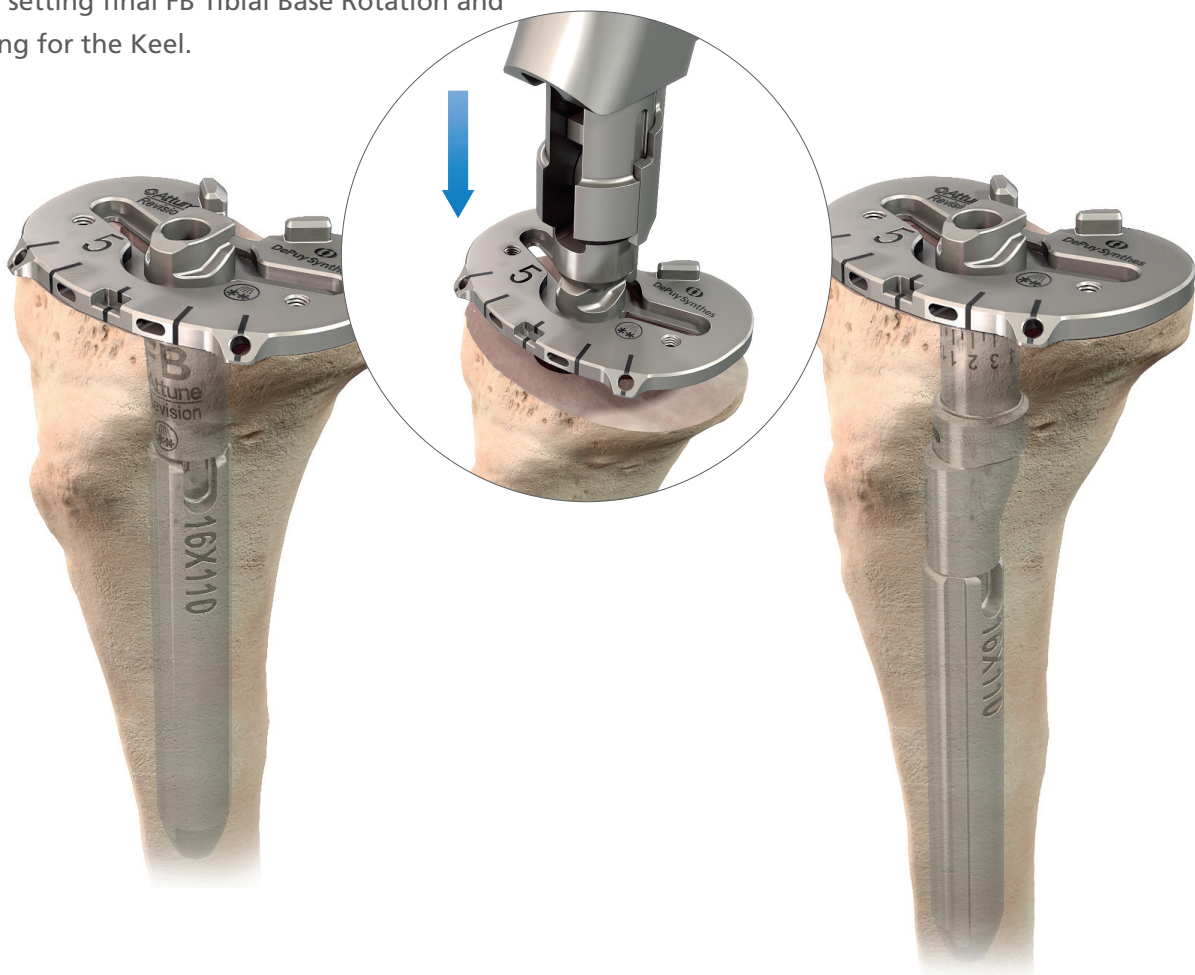

FB Tibial Base Trial Assembly with Straight Stem

FB Tibial Base Trial Assembly with Offset Stem



INFORMATION

Temporary anterior fixation holes and corresponding Pins are available to lock rotation during and after trialing if desired.

General Femoral Instrumentation

Torque Driver and 6 mm Hex Driver

The Torque Driver Assembly is utilized when tightening instruments to Femoral Broaches, Boss Trials, and Femoral Offset Adaptor Trials. The Assembly applies a torque to the constructs to aid in maintaining a tight connection throughout the surgical process and to aid in setting final implant rotation based off of the Femoral Trial construct.

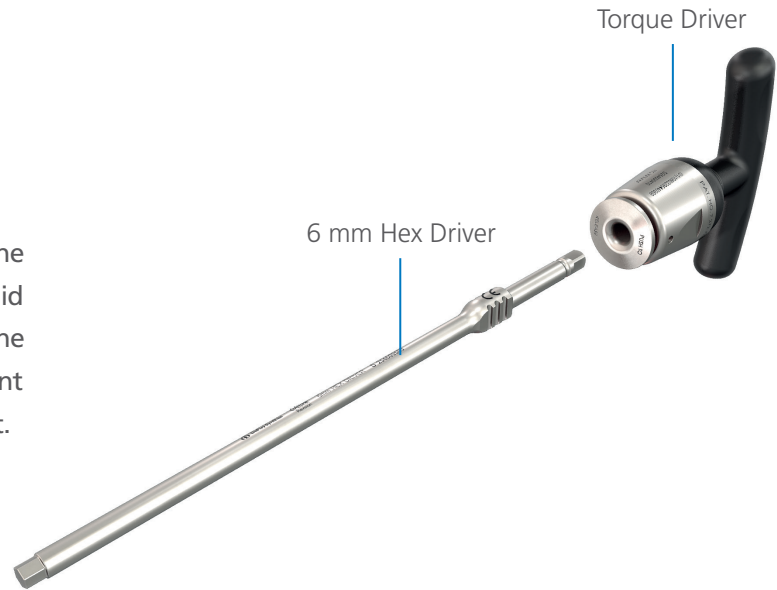

Tighten to “click” when assembling Femoral Instruments and associated constructs with the Torque Driver Assembly to ensure solid assembly throughout preparation and trialing.

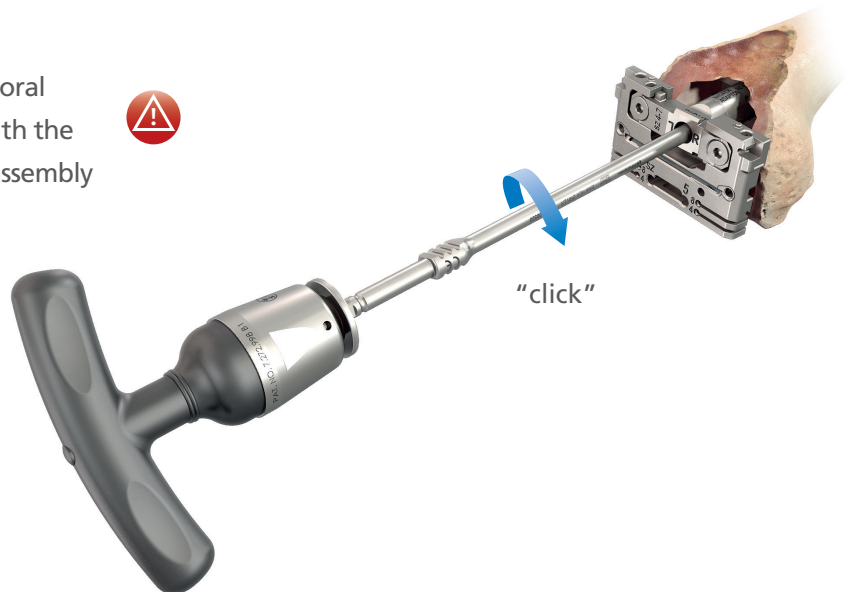

CAUTION

Not torquing to the “click” may result in Trial components loosening during use or extraction.

General Femoral Instrumentation

Femoral Trial Assembly - Boss Trial



Cut Through Trial



Straight Stem

The Boss Trial attaches to the proximal side of the Femoral Trial utilizing the Stem Trial Bolt passed through the Box region of the Femoral Trial. The Stem Trial then threads on to the Boss Trial.

The Cut Through Trial can be assembled with the IM Connector for the Cut Through Trial workflows in cases where it is desired to use the Cut Through Trial prior to final box preparation. Otherwise it should be assembled to the Box Trial (shown below).

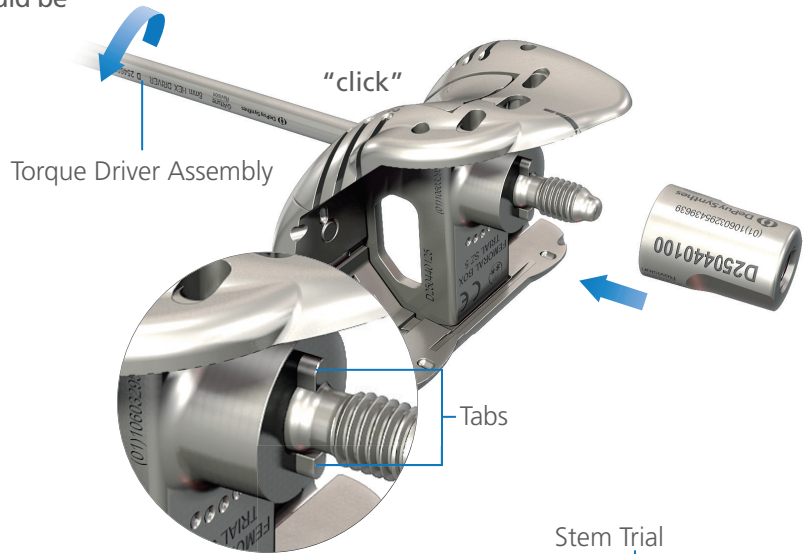
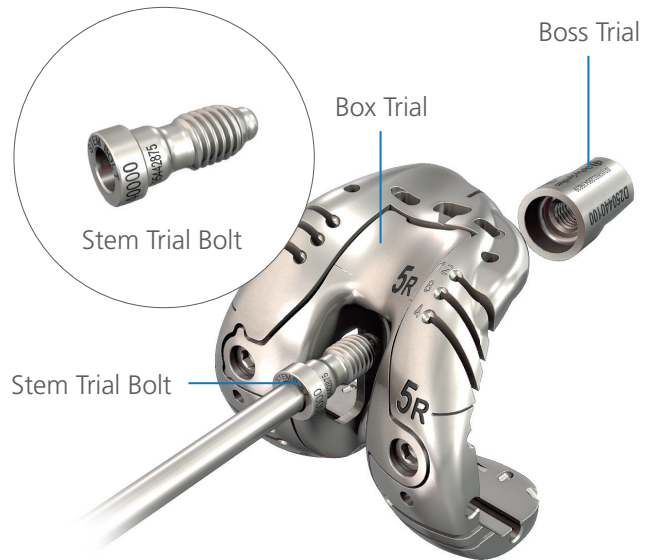

Box Trial and Boss Trial



INFORMATION

The distal surface of the Boss Trial has a recess to interface with the tabs on the box of the Femoral Trial components.

General Femoral Instrumentation

Femoral Trial Assembly - Boss Trial



Solid Femoral Trial



Straight Stem

The Boss Trial attaches to the proximal side of the Femoral Trial utilizing the Stem Trial Bolt passed through the Box region of the Femoral Trial. The Stem Trial then threads on to the Boss Trial.

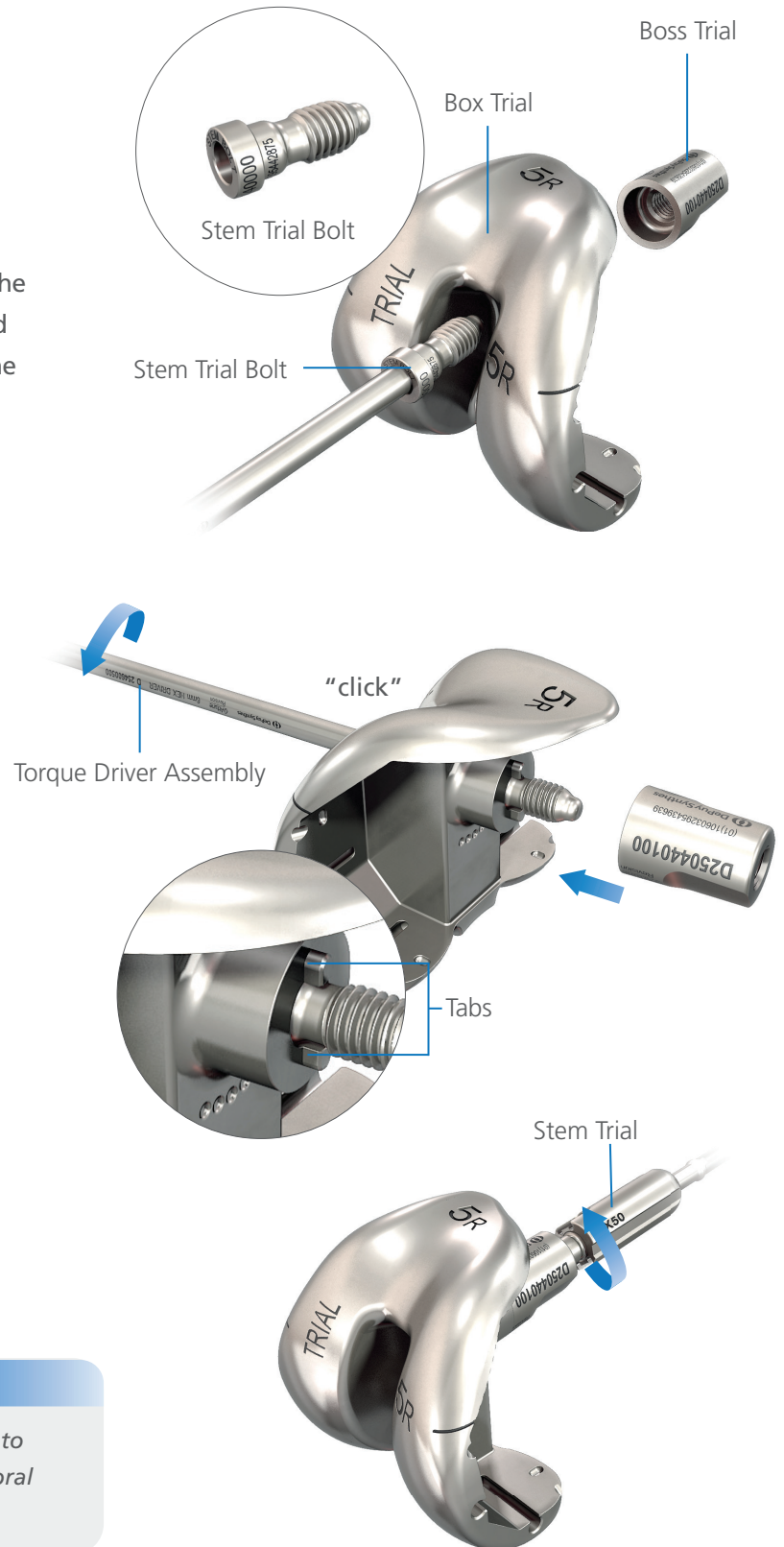

i INFORMATION

The distal surface of the Boss Trial has a recess to interface with the tabs on the box of the Femoral Trial components.

General Femoral Instrumentation

Femoral Trial Assembly - Offset Adaptor Trial for Offset Stem



Offset Stem

The Femoral Offset Adaptor Trial attaches to the proximal side of the Femoral Trial utilizing the Stem Trial Bolt passed through the Box region of the Femoral Trial. The Stem Trial threads on to the Femoral Offset Adaptor Trial.



Cut Through Trial



Solid Femoral Trial



Stem Trial Bolt



Stem Trial Bolt

Stem Trial Bolt

Stem Trial Bolt

Torque Driver Assembly

Torque Driver Assembly

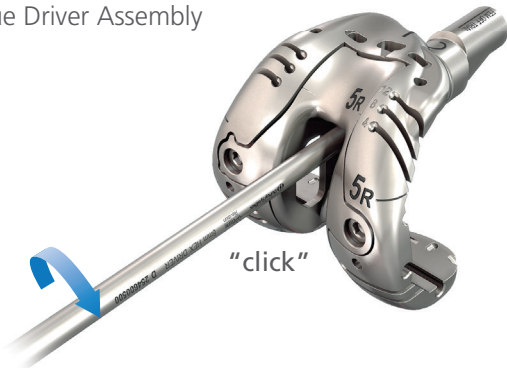

"click"

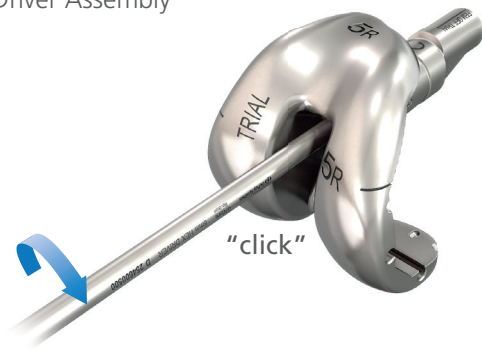

"click"

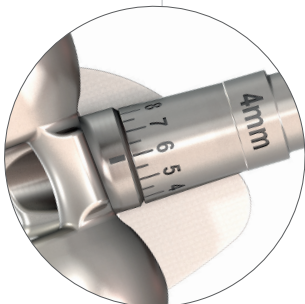

Orientation Feature

General Femoral Instrumentation

Femoral Trial Assembly - Broach Trial for Femoral Sleeve



Sleeve and Stem

The Femoral Broach attaches directly to the Box of the Femoral Trial *via* the Broach Bolt.

The Femoral Trial will generally be assembled to the Broach when it is in situ on the bone.

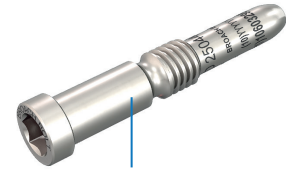

Broach Bolt



Cut Through Trial



Solid Femoral Trial

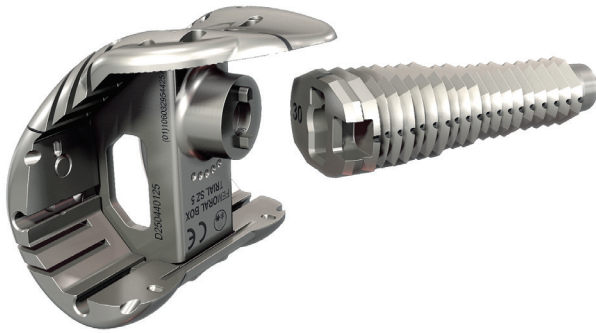

Torque Driver Assembly

Broach Bolt



Torque Driver Assembly

Broach Bolt



Orientation Feature

General Femoral Instrumentation

Femoral Boss Reamer

When reaming with the Femoral Boss Reamer the appropriate Stem Trial should always be assembled to the end of the Boss Reamer.

There are different depth indications on the Femoral Boss Reamer:

1) The single engraved line closest to the Hudson Connection:

Ream to this line any time the Boss Reamer is going through a Reamer Guide.

Additionally, the Modular Stop may be assembled to this line to aid in controlling the depth of the Reamer and should be seated flush against the Reamer Guide.

2) The grouping of three lines closest to the cutting flutes of the Boss Reamer:

In preparations where the Boss Reamer is being Guided by a Stem Trial (not passing through a Reamer Guide), seat the Boss Reamer until the appropriate femoral size marking group is aligned with the distal surface of the femur (or distal surface of any prepared Augments).

The size groupings on the Boss Reamer represent the distal bone surface and not the anticipated joint line.

The Modular Stop will NOT connect to these positions.

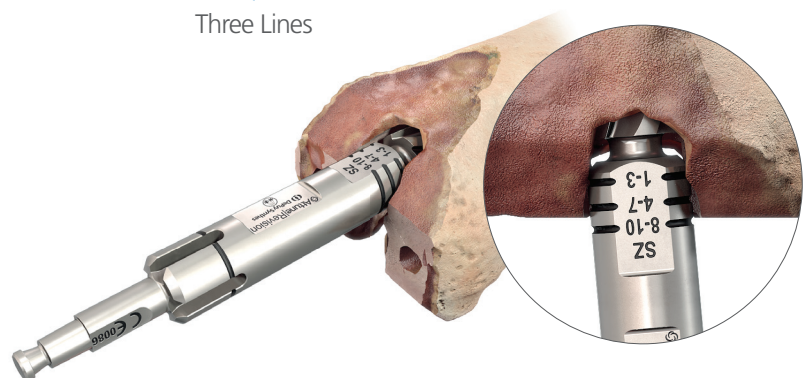
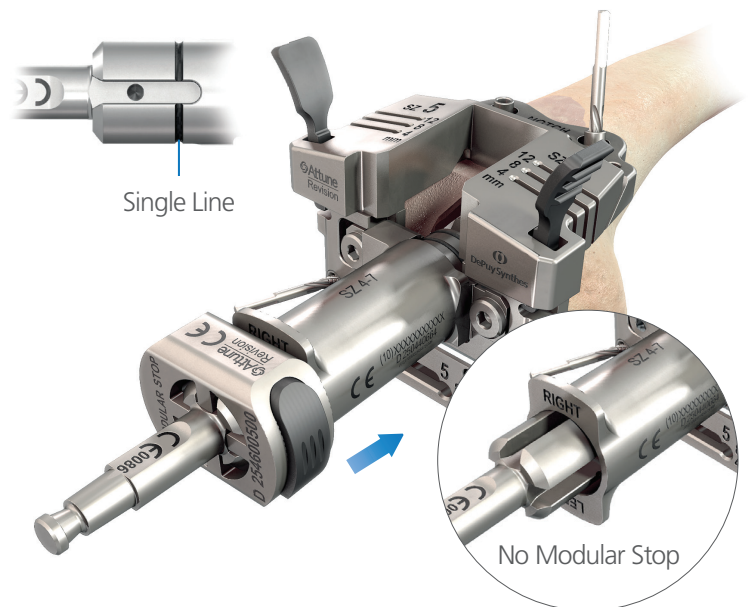
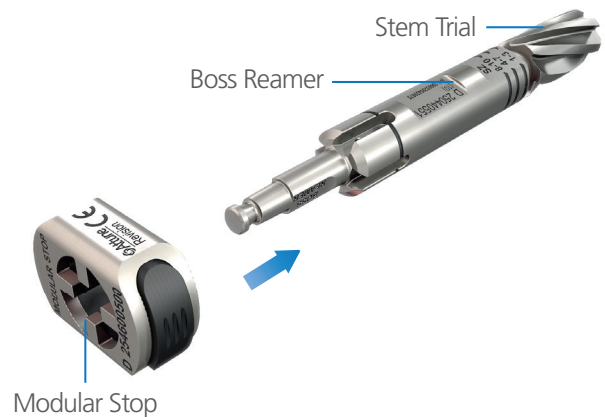

General Femoral Instrumentation

Femoral Augment Trial Assembly



The Femoral Augment Trials slide in from the side of the Femoral Trials and have a magnet for retention.

When assembling the Augment Trials to the Femoral Trial while on the bone, it may be necessary to slightly distract the Femoral Trial to allow clearance for assembly.

To remove the Femoral Augment Trial:

1. Gently press on the posterior aspect of the Distal Augment Trial **until the anterior aspect tilts upwards**.
2. Slide to the exterior of the Femoral Component.

For the Posterior Augment Trial:

1. Gently press on the distal aspect.
2. Slide exteriorly.



INFORMATION

Where appropriate, Femoral Augment resections may be made through the Conventional Cut Guide, Notch Guide, or Cut Through Trial.



INFORMATION

Femoral Augment Trials are shared across 2 sizes: 1 - 2, 3 - 4, 5 - 6, 7 - 8, and 9 - 10 and may be utilized on the "Left or Right" medial or lateral for the corresponding Distal or Posterior Augment Trials; the Femoral Augment Implant sizes correspond to the Femoral Implant size and are not shared across sizes. Additionally, each Augment Trial is marked with two colored dots which correspond to the size and color markings for the compatible Femoral Component. The Compatibility Chart can be found on [Page 222](#).



CAUTION

The ATTUNE Revision Femoral Augment Trials contain magnets. These devices should be kept at a safe distance from a patient's active implantable medical device(s) (i.e. pacemaker) in order to avoid adversely affecting the device. The Femoral Augment Trials should be kept at an appropriate location when not in use in the surgical site.

General Femoral Instrumentation

Distalizing Gauge

The Distalizing Gauge may be utilized to provide an additional reference to the epicondyles and ultimately joint line placement. There are reference marks on the Distalizing Gauge in 5 mm increments to allow for assessment of the distance of the joint line from the medial or lateral epicondyle, as desired.

The "0" line indicates the joint line of the Femoral Component and is level with:

- The articular surface of the Revision Femoral Trials
- The distal surface of the Conventional Cut Guide

The Distalizing Gauge slides into:

- The channels for the Distal Spacers in the Conventional Cut Guide
- The channels for the Femoral Augment Trials in the Femoral Trials
- Or the channels in the Medial and Lateral sides of the Broach Stop

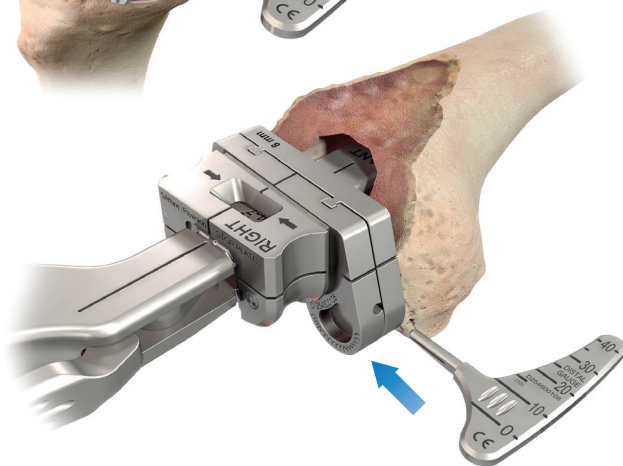
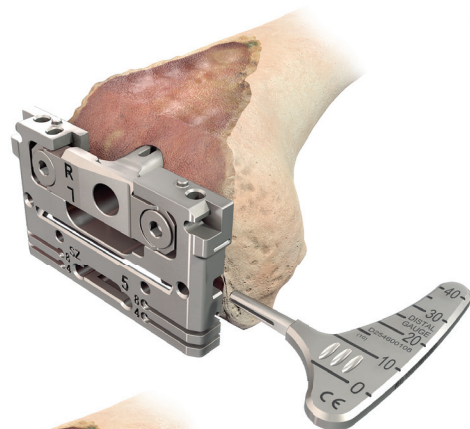
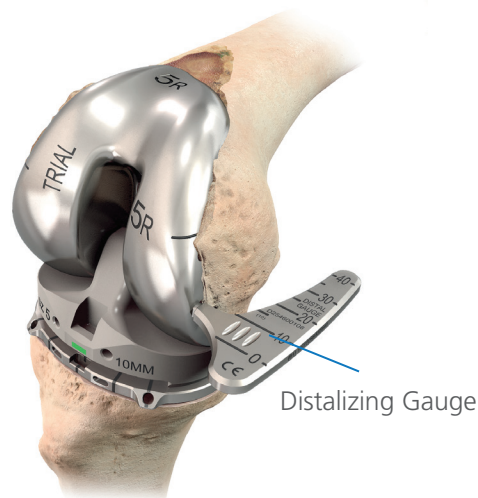

Revision Femoral Preparation - Solutions

Solution 1: Revision Femoral Component with Short Cemented Stem With Cut Through Trials (go to **page 63**)



Cut Through Trial



This workflow positions the Femoral Component with a Short Cemented Stem relative to the femoral bone resections as determined using the ATTUNE Primary INTUITION AIP Chamfer Block from the ATTUNE Primary INTUITION Instruments Surgical Technique.

Solution 2: Revision Femoral Component with Short Cemented Stem With Solid Femoral Trials (go to **page 68**)



Conventional Cut Guide



This workflow positions the Femoral Component with a Short Cemented Stem relative to the femoral bone resections as determined using the ATTUNE Primary INTUITION AIP Chamfer Block from the ATTUNE Primary INTUITION Instruments Surgical Technique.

Revision Femoral Component with Intramedullary (IM) Preparation

Solutions 3 and 4 position the Femoral Component relative to the IM Canal with the positioning being driven by the fixation achieved through Long Stems or Femoral Sleeves.



Straight Stem



Offset Stem



Femoral Sleeve and Stem

Solution 3: Revision Femoral Component with Intramedullary (IM) Preparation with Conventional Cut Guide (go to **page 74**)



Conventional Cut Guide



Revision Femoral Component with Intramedullary (IM) Preparation with FE Guide (go to **page 74**)

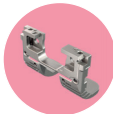

FE Guide



Solution 4: Revision Femoral Component with Intramedullary (IM) Preparation with Cut Through Trials (go to **page 74**)



Cut Through Trial



Femoral Preparation



Cut Through Trial

This is the Extramedullary Preparation of the Revision Femoral Component with a 30, 50, or 80 mm Cemented Stem.

When using an 80 mm long Cemented Stem (14 mm or 16 mm in diameter) and based on pre-operative templating, the size of the Femoral Stem and bow of the femoral canal should be taken into consideration when determining if the longer Stem is suitable for the patient.

This technique positions the Stem based on the femoral bone cuts rather than the patient's intramedullary canal.

Follow the femur preparation stages described in the ATTUNE Knee System ATTUNE Primary INTUITION Instruments Surgical Technique. Once the chamfer resections are made, remove the ATTUNE Primary INTUITION A/P Chamfer Block.

Delay resecting the Femoral Box as the Revision Box will be prepared using the Cut Through Trial to set the M/L position.

i INFORMATION

Reference the ATTUNE Knee System ATTUNE Primary INTUITION Instruments Surgical Technique for femur preparation.



CAUTION

The ATTUNE Revision Femoral Augment Trials contain magnets. These devices should be kept at a safe distance from a patient's active implantable medical device(s) (i.e. pacemaker) in order to avoid adversely affecting the device. The Femoral Augment Trials should be kept at an appropriate location when not in use in the surgical site.



Femoral Finishing - Cut Through Trial

Take the corresponding size Revision Cut Through Femoral Trial (without any attachments assembled) and place on the prepared distal femur. Locate the Cut Through Trial in the desired M/L position on the prepared distal femur.

Pin the Cut Through Trial in place.

If Augments are required, make the appropriate resections through the Distal and/or Posterior Augment slots ensuring that Pins are not in the way. Femoral Augment Trials may be loaded from the side. 

Pins can pass through the Augment Trials after they are in place, however, the Pins must be removed to perform the resection and to allow for the trials to slide into position.



INFORMATION

The Cut Through Trials are available in Sizes 3 - 10. The Conventional Cut Guide must be utilized to prepare femurs of sizes 1 or 2.

Femoral Preparation

Femoral Finishing - Cemented Stem Preparation



Cut Through Trial

Introduce the correct side "Left or Right" and size (3, 4 - 7, or 8 - 10) Femoral Trial Reamer Guide and attach to the Cut Through Trial by tightening the Hexes using the Torque Limiting Screwdriver Assembly.

Introduce the 14 mm Femoral Reamer Bushing to the Reamer Guide.

Attach the Modular Stop to the desired 30, 50, or 80 mm line of the 14 mm Cemented Femoral Reamer.

Seat the Reamer to the Stop. 

Proceed to Boss Preparation on [page 65](#).

If a 16 mm x 80 mm Cemented Stem is desired, introduce the 16 mm Femoral Reamer Bushing to the Reamer Guide.

Ensure the 80 mm long Stem is appropriate for the patient's anatomy as previously described on [page 63](#).

Attach the Modular Stop to the 80 mm line of the 16 mm Cemented Femoral Reamer.

Seat the Reamer to the Stop. 

Proceed to Boss Preparation on [page 65](#).

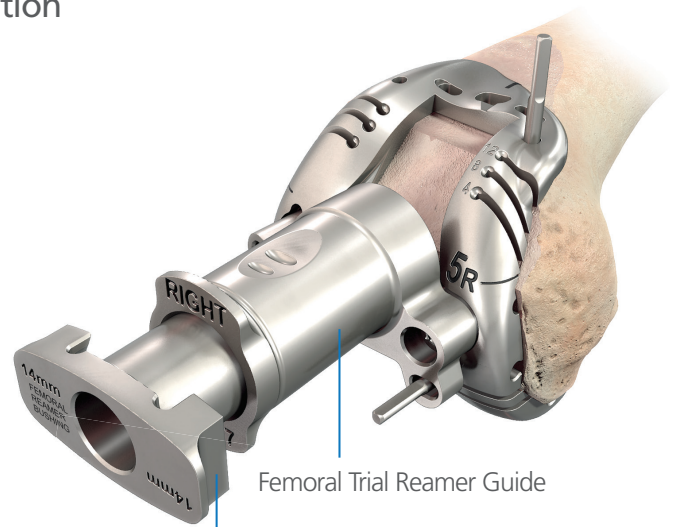

Femoral Reamer Bushing

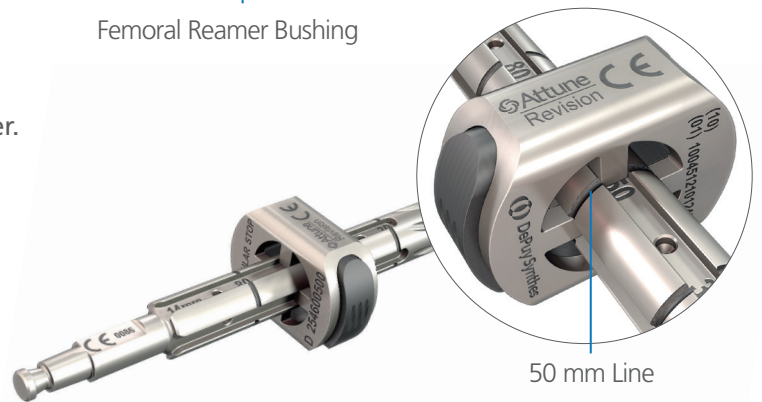

50 mm Line

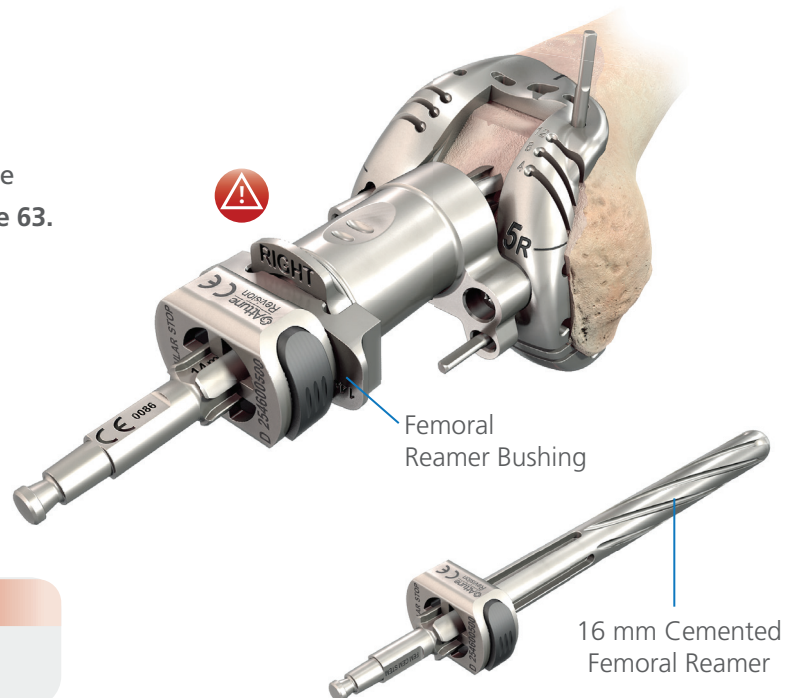

Femoral Reamer Bushing

16 mm Cemented Femoral Reamer



CAUTION

Avoid cortical contact.

Femoral Preparation

Femoral Finishing - Boss Preparation



Cut Through Trial

To prepare for the Femoral Boss, remove the Femoral Reamer Bushing and prepare the femoral canal with the Femoral Boss Reamer.

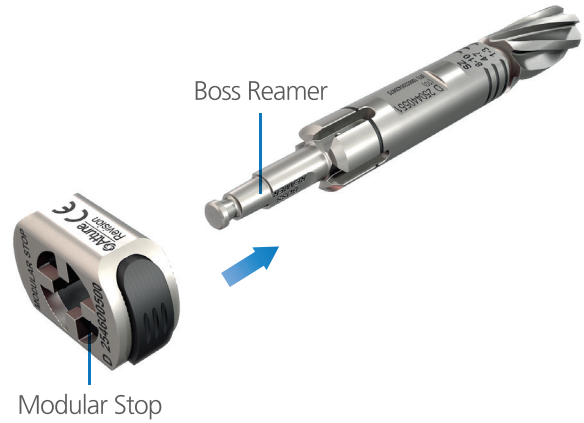

Assemble the appropriate Cemented Stem Trial to the Femoral Boss Reamer and attach the Modular Stop to the most proximal line on the Femoral Boss Reamer.

Seat the Reamer to the Stop.

Remove all instruments except the Cut Through Trial and Pins.

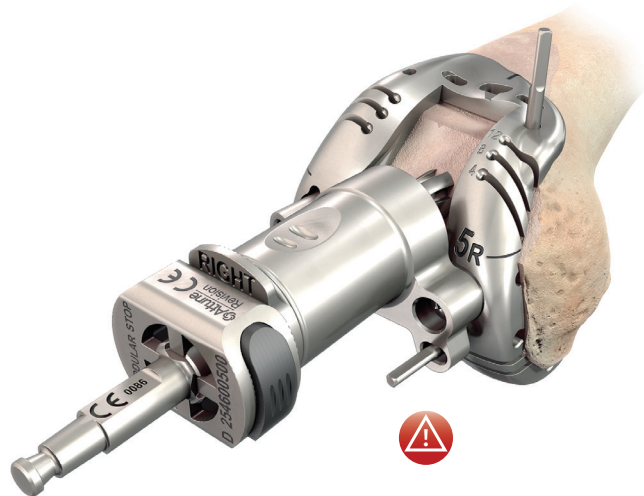

CAUTION

Do not reverse ream.

Femoral Preparation

Femoral Finishing - Box Resection



Cut Through Trial

A Reciprocating Saw is recommended for resecting the sides of the Femoral Box. Use the side walls of the box opening on the Cut Through Trial as a guide.

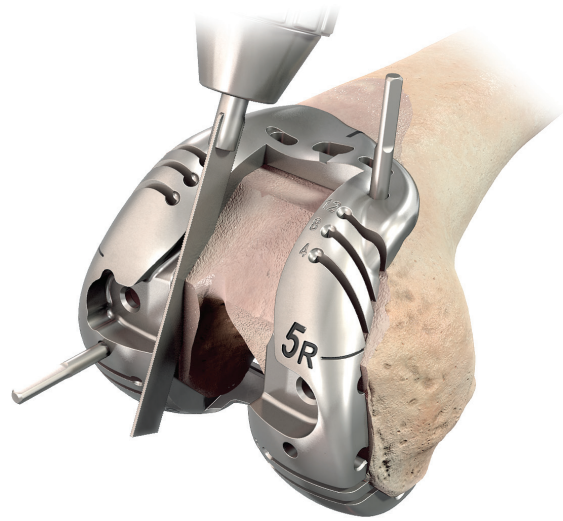

Attach the Box Cut Platform to the anterior flange of the Cut Through Trial and proceed to resect the top of the box with the Reciprocating Saw or Narrow Saw Blade. A groove is machined into the bridge between the posterior condyles, once the top of the box resection has been completed this groove is fully visible.

Check completeness of the box resection with the Angel Wing against the Box Cut Platform and along the sides of the box opening in the Cut Through Trial. 

Remove the Box Cut Platform.

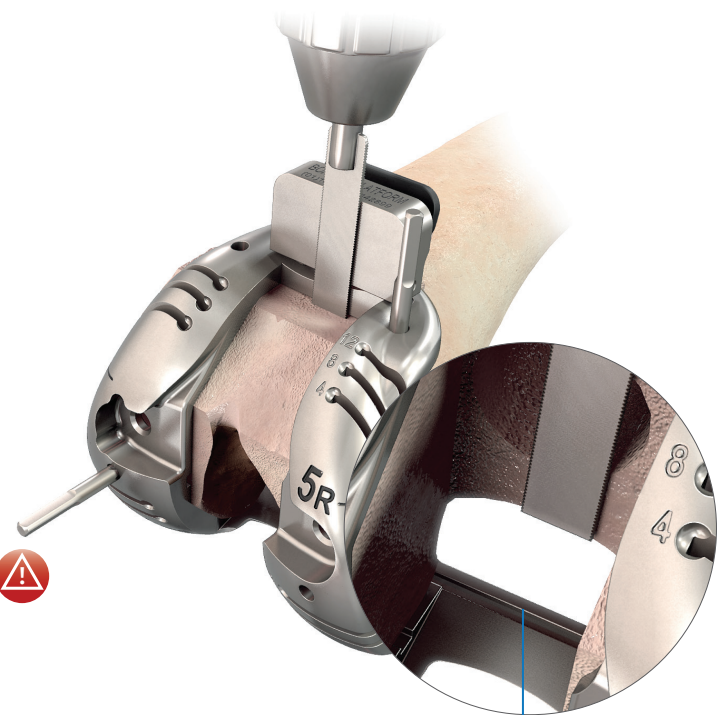

Groove



CAUTION

If the box resection is not complete, the connecting components of the Cut Through Trial may not seat.

Femoral Preparation

Femoral Trial Assembly



Cut Through Trial

Assemble the Cut Through Femoral Trial with the Box Trial, Boss Trial, Stem Trial Bolt, Stem Trial, and any appropriate Augment Trials.

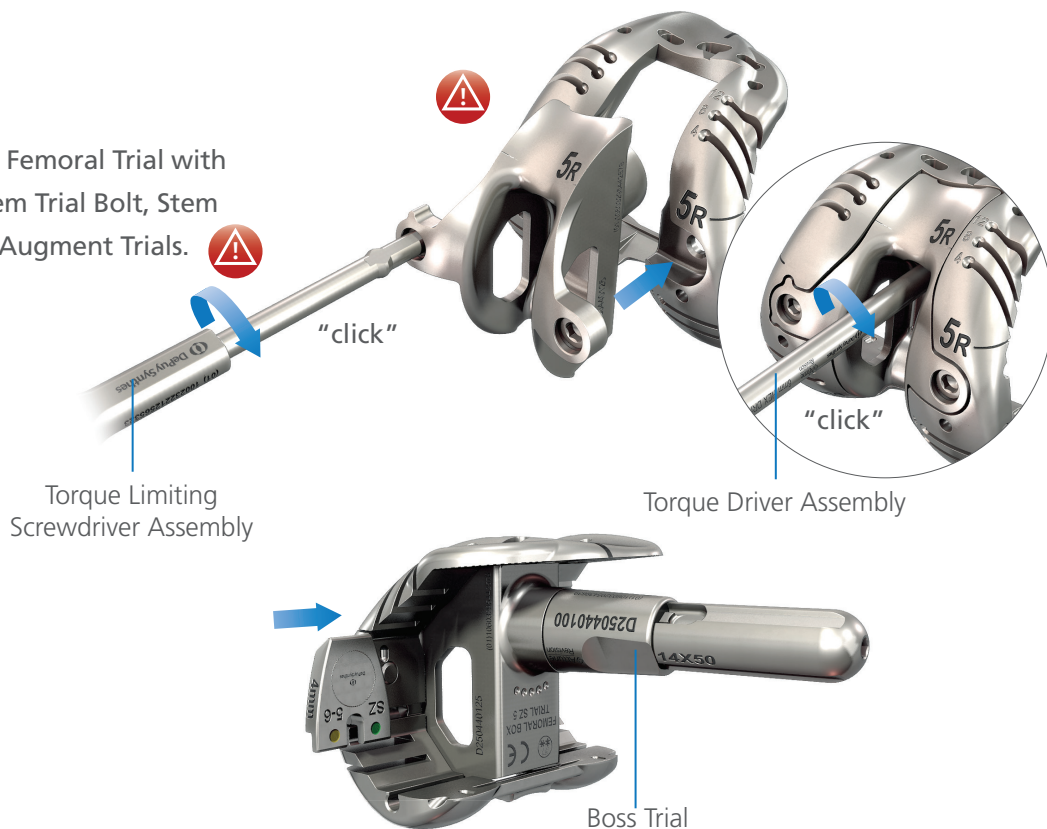

Introduce the Femoral Trial Assembly to the prepared femur. Utilize the ATTUNE System Impactor to seat the Femoral Trial Assembly.

Introduce the Revision Tibial Insert Trial and proceed to setting Tibial Base Rotation on **page 151**.



ATTUNE System Impactor

CAUTION

The Box Trial is size and side specific.

CAUTION

The ATTUNE Revision Femoral Augment Trials contain magnets. These devices should be kept at a safe distance from a patient's active implantable medical device(s) (i.e. pacemaker) in order to avoid adversely affecting the device. The Femoral Augment Trials should be kept at an appropriate location when not in use in the surgical site.

CAUTION

If Femoral Trial Assembly does not seat to the intended depth, verify that the depth of the box resection was correct.

Femoral Preparation



Conventional Cut Guide

This is the Extramedullary Preparation of the Revision Femoral Component with a 30, 50, or 80 mm Cemented Stem.

When using an 80 mm long Cemented Stem (14 mm or 16 mm in diameter) and based on pre-operative templating, the size of the Femoral Stem and bow of the femoral canal should be taken into consideration when determining if the longer Stem is suitable for the patient.

This technique positions the Stem based on the femoral bone cuts rather than the patient's intramedullary canal.

Follow the femur preparation stages as described in the ATTUNE Knee System ATTUNE Primary INTUITION Instruments Surgical Technique. Once the chamfer resections are made remove the ATTUNE Primary INTUITION A/P Chamfer Block. **Delay resecting the Femoral Box as the Revision Box will be prepared with the Conventional Cut Guide and Revision Notch Guide.**

Take the corresponding Conventional Cut Guide and Revision Notch Guide and place on the prepared distal femur. Locate the Assembly in the desired M/L position on the prepared distal femur.

Pin the Conventional Cut Guide and Revision Notch Guide in place.

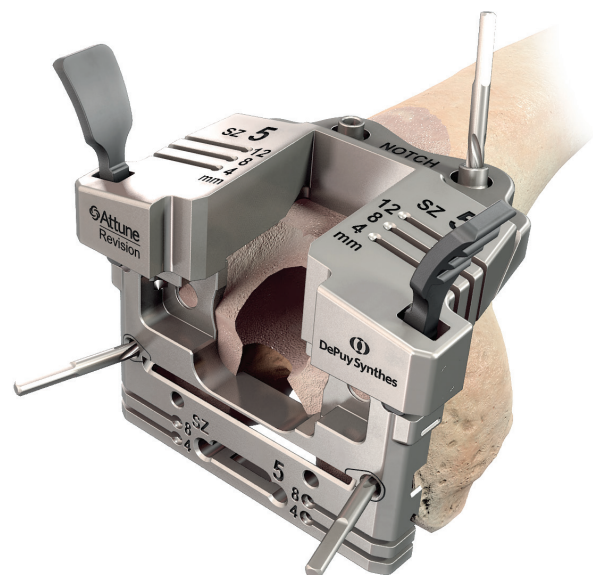
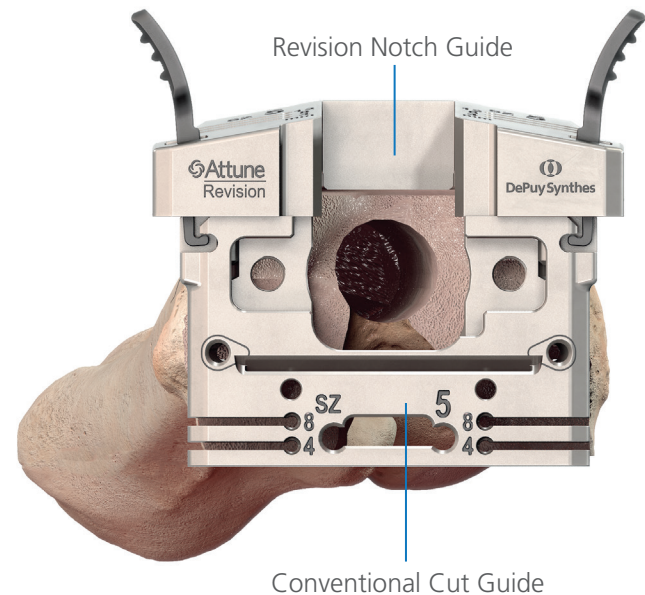

Femoral Preparation

Augment and Cemented Stem Preparation



Conventional Cut Guide

If Augments are required, make the appropriate resections through the Distal and/or Posterior Augment slots ensuring that the Pins are not in the way.

Insert the appropriate Distal Spacers by loading from the side of the Conventional Cut Guide.

Introduce the Conventional Cut Guide Reamer Guide so that the correct text "LEFT" or "RIGHT" is legible when assembled to the Conventional Cut Guide and the 14 mm Femoral Reamer Bushing.

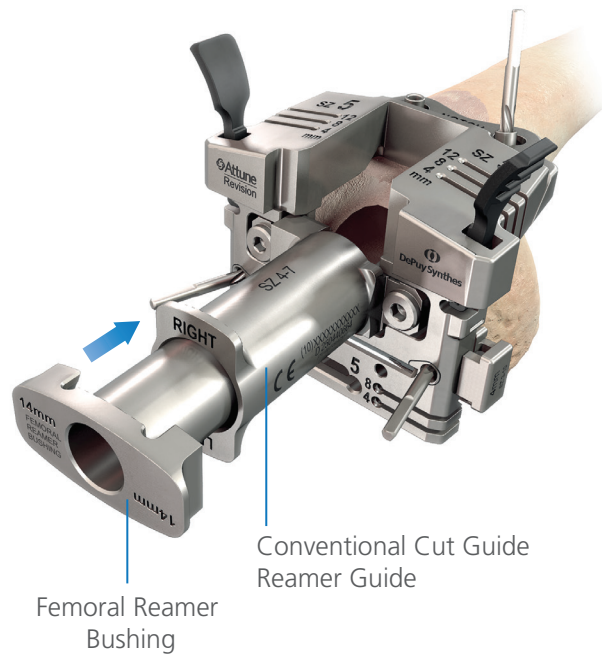
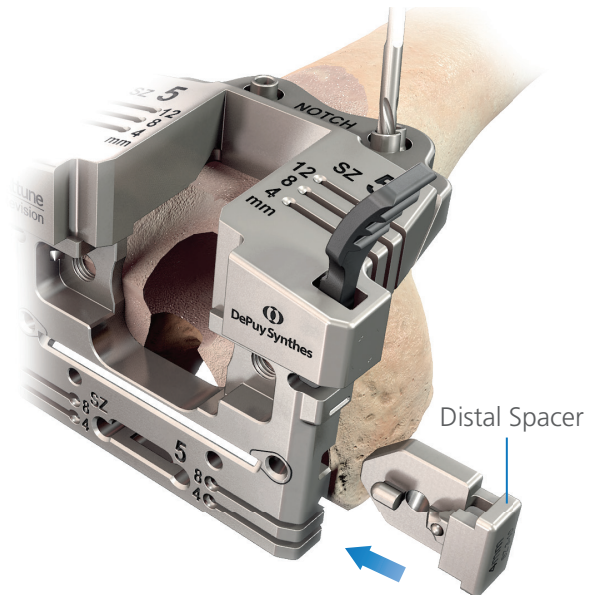
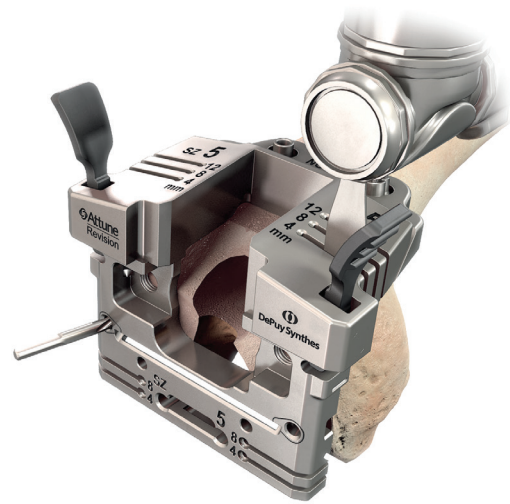

Femoral Preparation

Cemented Stem Preparation



Conventional Cut Guide

Attach the Modular Stop to the desired 30, 50, or 80 mm line of the 14 mm Cemented Femoral Reamer.

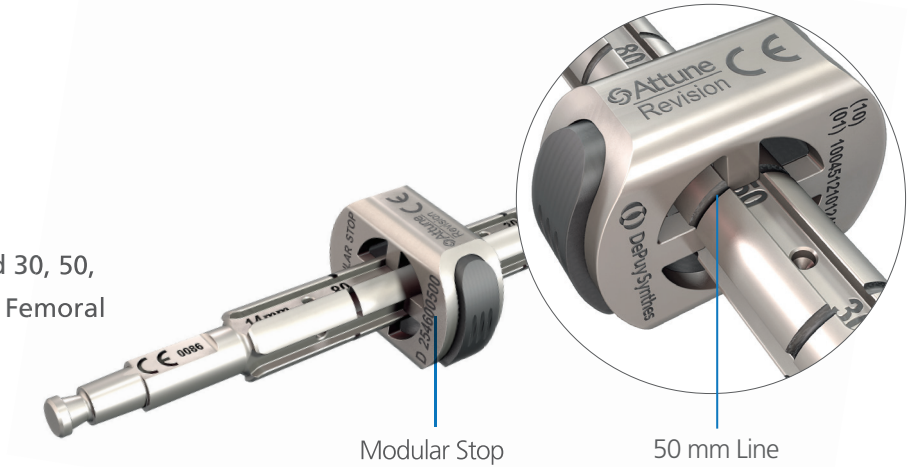

Seat the Reamer to the Stop.

Proceed to **Boss Preparation** on page 71.

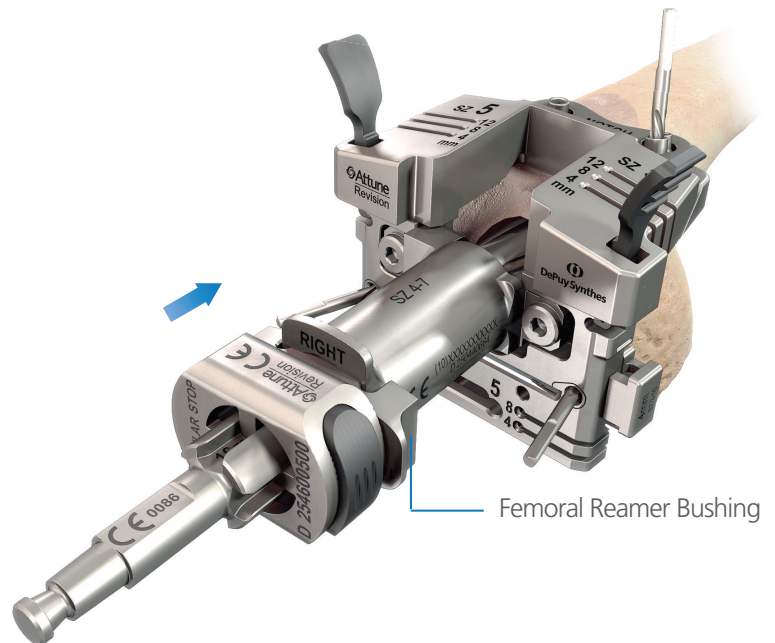

If a 16 mm x 80 mm Cemented Stem is desired, introduce the 16 mm Femoral Reamer Bushing to the Reamer Guide. **Ensure the 80 mm long Stem is appropriate for the patient's anatomy as previously described on page 63.**

Attach the Reamer Stop to the 80 mm line of the 16 mm Cemented Femoral Reamer.

Seat the Reamer to the Stop.

Proceed to **Boss Preparation** on page 71.



CAUTION

Avoid cortical contact.

Femoral Preparation

Boss Preparation



Conventional Cut Guide

To prepare for the Femoral Boss, remove the Femoral Reamer Bushing.

Assemble the Stem Trial to the Femoral Boss Reamer and attach the Reamer Stop to the most proximal line on the Femoral Boss Reamer.

Seat the Reamer to the Stop.

With the Femoral Boss prepared, remove the Boss Reamer and the Conventional Cut Guide Reamer Guide Assembly.

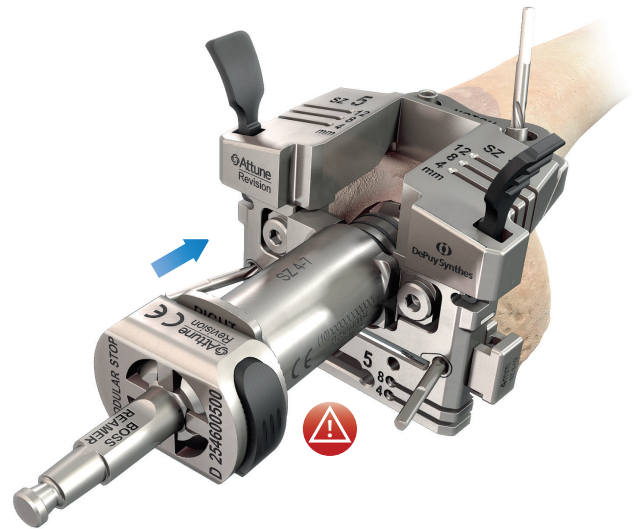
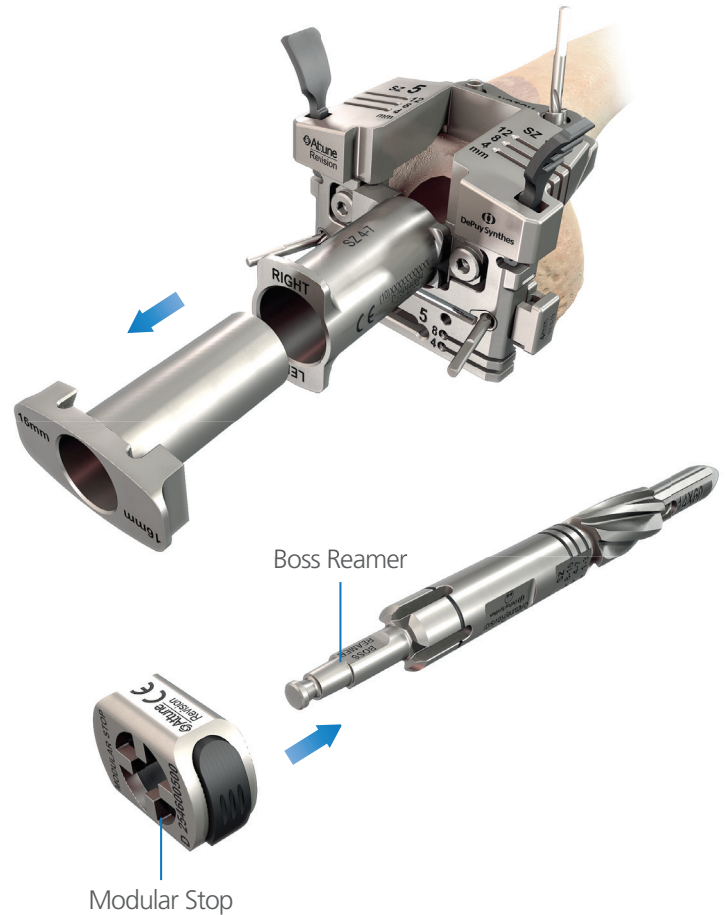

CAUTION

Do not reverse ream.

Femoral Preparation

Box Resection and Femoral Trialing



Conventional Cut Guide

Resect the sides and top of the Femoral Box with a Reciprocating Saw. Use the side walls and top ledge of the box as a guide.

With the femoral preparation complete, remove the Conventional Cut Guide Assembly.

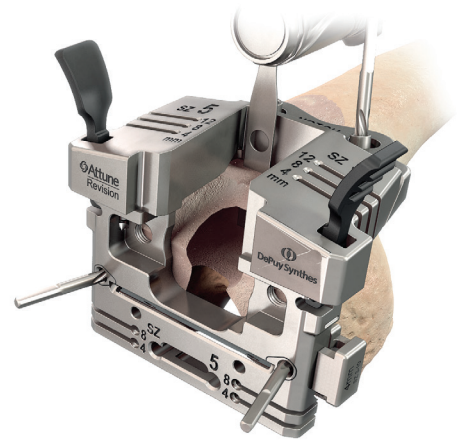

Femoral Trialing

Assemble the Solid Femoral Trial with the Boss Trial, Stem Bolt, Stem Trial, and any appropriate Augment Trials. 

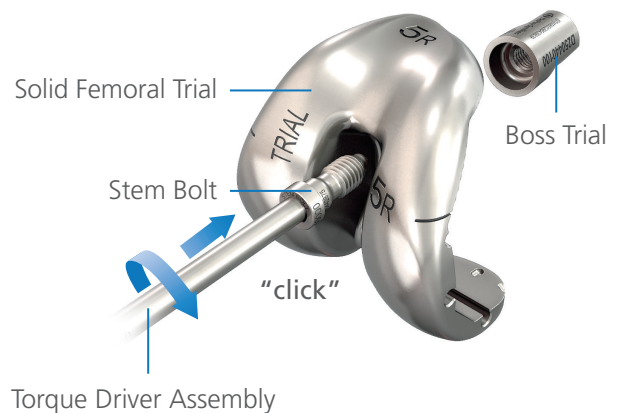

CAUTION

The ATTUNE Revision Femoral Augment Trials contain magnets. These devices should be kept at a safe distance from a patient's active implantable medical device(s) (i.e. pacemaker) in order to avoid adversely affecting the device. The Femoral Augment Trials should be kept at an appropriate location when not in use in the surgical site.



Femoral Preparation

Femoral Trialing



Conventional Cut Guide

Introduce the Solid Femoral Trial Assembly to the prepared femur. Utilize the ATTUNE System Impactor to seat the Femoral Trial Assembly.



Introduce the Revision Tibial Insert Trial and proceed to Setting Tibial Base Rotation on page 151.



CAUTION

If Femoral Trial Assembly does not seat to the intended depth, verify that the depth of the box resection was correct.

Femoral Preparation

According to user preference and amount of distal femoral bone loss, choose one of the following to perform the femoral bone preparation:

For either workflow, proceed to **pages 75 - 79** prior to progressing to Conventional Cut Guides or Cut Through Trials.

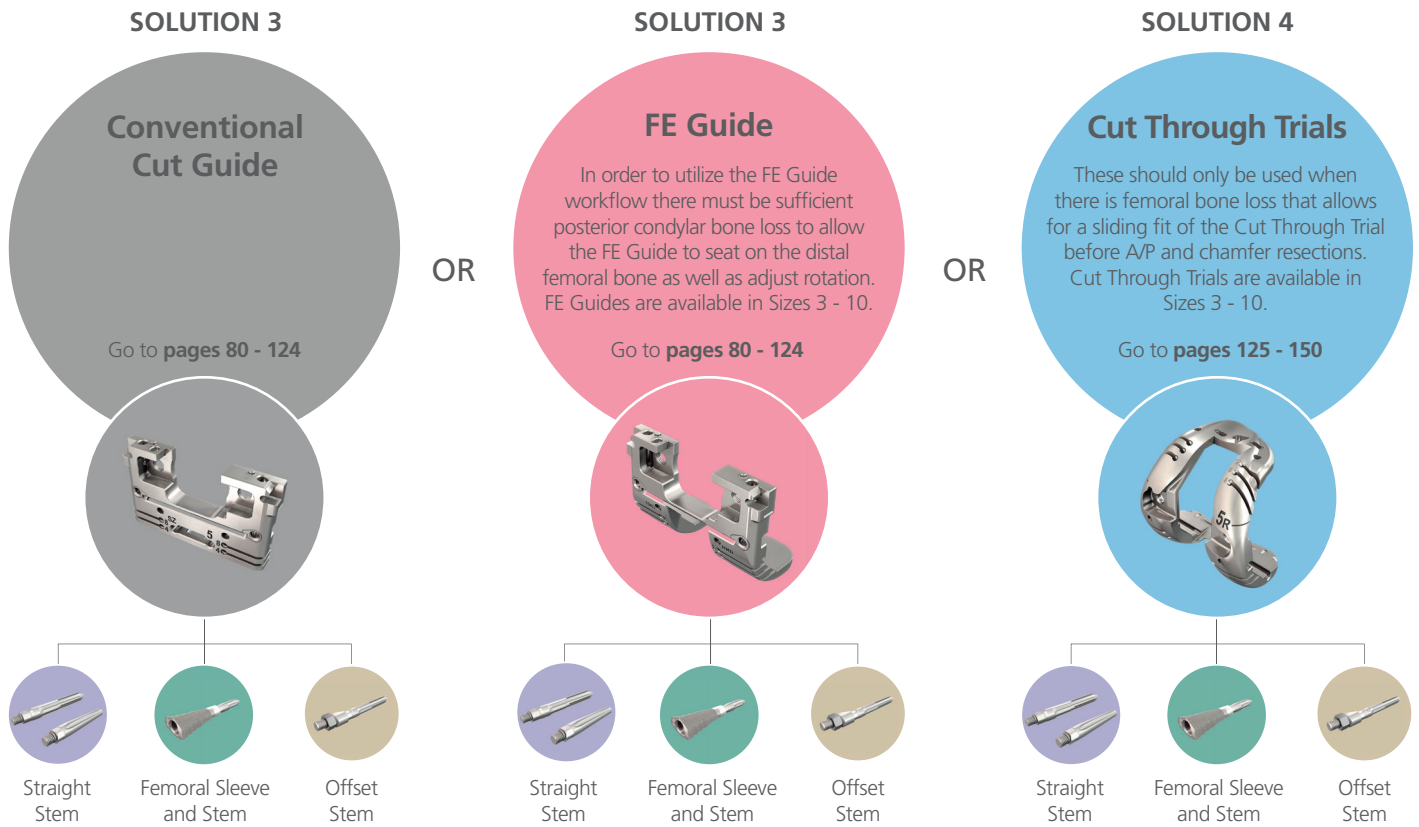

i **INFORMATION**

Regardless of the instruments used for these remaining femoral bone preparation steps, either the Cut Through Trial or Solid Femoral Trial can be used for trialing and range of motion evaluation.

Femoral Preparation

Canal Reaming



Cut Through Trial



Conventional Cut Guide

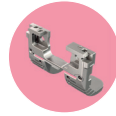

FE Guide



Straight Stem

Utilize the "With Stem" indications on the Femoral Reamer Reference Tool. Refer to **pages 15 - 17**.



Offset Stem

Utilize the Femoral side of the Offset Reamer Reference Tool. Refer to **pages 15 - 17**.



Femoral Sleeve and Stem

Utilize the "With Sleeve and Stem" indications on the Femoral Reamer Reference Tool. Refer to **pages 15 - 17**.

Assemble the Canal Reamer to either the Reamer T-Handle or standard power. During canal preparation for Femoral Sleeves, care should be taken to posteriorize the Reamer in the distal femoral bone and not allow for the hard posterior bone to drive the femoral position anteriorly i.e. so that the Femoral Component is not extended.

Straight canal ream to appropriate depth and desired canal fit, remembering to finish on an even diameter Reamer. Refer to **pages 18 - 20**.



16 mm Canal Reamer

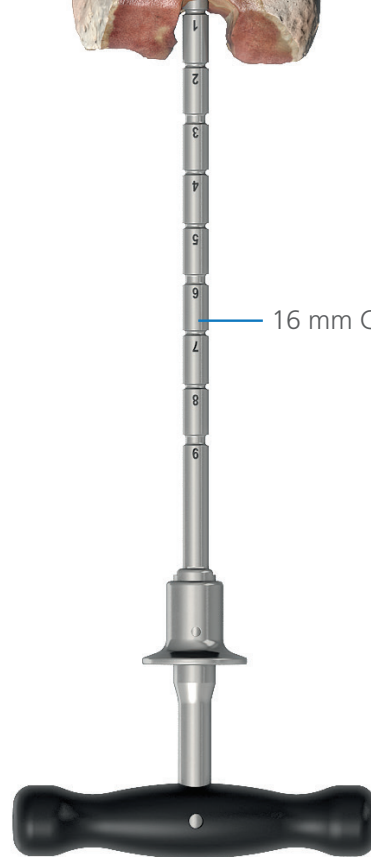

Femoral Preparation

Distal Resection



Cut Through Trial



Conventional Cut Guide



FE Guide



Straight Stem



Offset Stem



Femoral Sleeve and Stem

It is possible to use the INTUITION Distal Femoral Guide to perform a distal clean up cut. Use the Jig prior to canal reaming and follow the instructions in the ATTUNE Knee System ATTUNE Primary INTUITION Instruments Surgical Technique, setting the instrument to 5 degrees valgus and set for a minimal amount of resection.

Alternatively, the distal femoral resection can be made off of the Canal Reamer as described. After progressively reaming, retain the even diameter Canal Reamer in the femoral canal.

Assemble the Revision Distal Femoral Mount to the Revision Distal Femoral Outrigger. Ensure the correct "R5" for Right, 5 degrees valgus or "L5" for Left, 5 degrees valgus is legible on the Distal Femoral Mount.

Assemble the INTUITION Distal Femoral Cutting Block to the Revision Distal Femoral Outrigger.

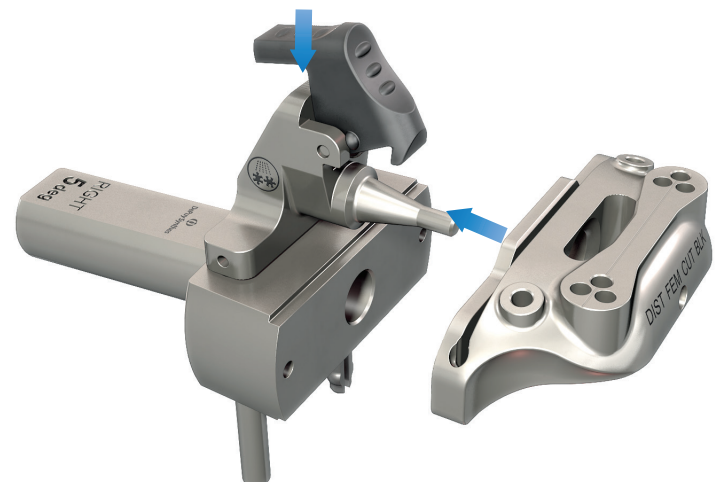
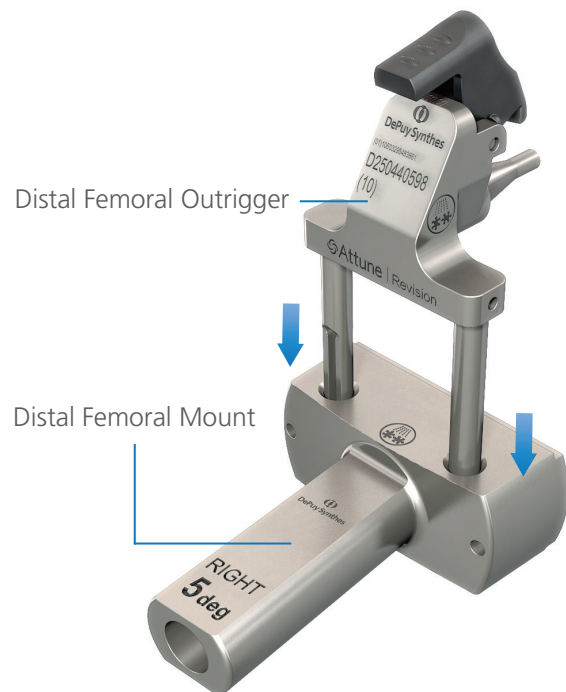

Femoral Preparation

Distal Resection



Cut Through Trial



Conventional Cut Guide

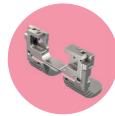

FE Guide



Straight Stem



Offset Stem



Femoral Sleeve and Stem

Slide the Distal Femoral Jig Assembly over the shaft of the Canal Reamer until the Distal Femoral Mount rests on the most prominent distal femoral bone.

The Cutting Block is positioned so that it takes a 2 mm clean up resection from the bone contacting surface of the Distal Femoral Mount.

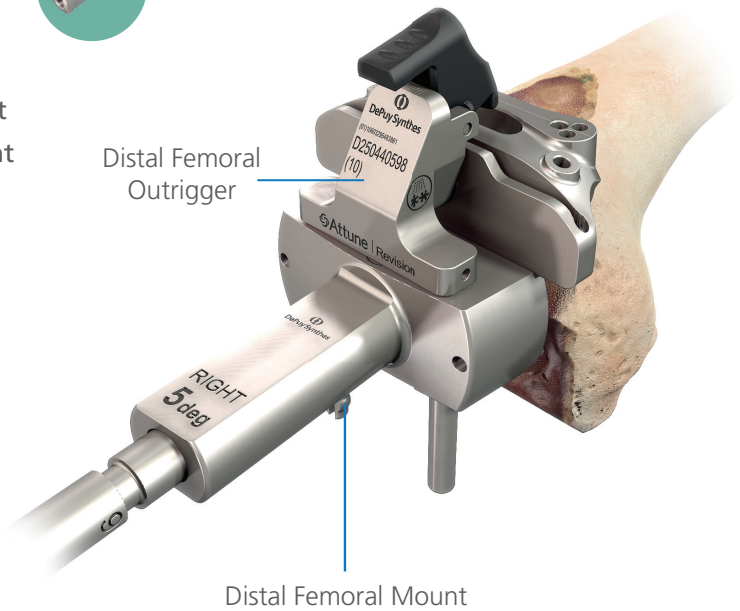

If the Distal Femoral Jig Assembly does not rest on the most prominent distal bone, an Angel Wing may be utilized through the slot of the Cutting Block to reference the prominent bone. Once pinned through the holes with a central line, the Cutting Block can be repositioned by using the Distal Pin Holes in the Block to translate it proximally 2 mm.

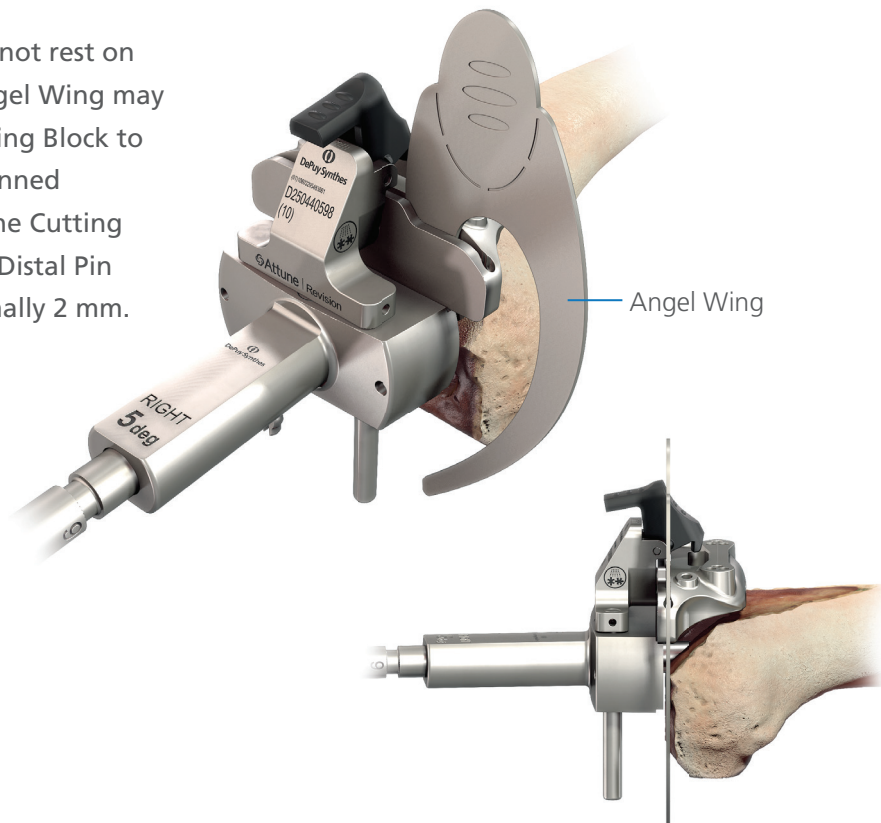

Femoral Preparation

Distal Resection



Cut Through Trial



Conventional Cut Guide

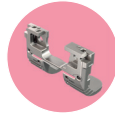

FE Guide



Straight Stem



Offset Stem



Femoral Sleeve and Stem

Secure the Cutting Block to the femur with two Universal or Non-Headed Pins through the holes marked with a center line. If necessary for additional stability, insert a Universal or Non-Headed Pin through one of the Divergent Pin Holes on the Cutting Block.

Disengage the Distal Femoral Cutting Block from the Outrigger Slide by pressing the lever on the Outrigger. Pull the entire Instrument distally.

Optionally, the distal femoral resection may be made with the Distal Femoral Jig Assembly in place by using a narrow, 1/2 inch, Saw Blade.

To further adjust the distal resection depth once the Distal Femoral Jig is removed, use the Distal or Proximal Pin Holes, that move the Block 2 mm in either direction.

If desired, the Canal Reamer can be removed from the femoral canal in order to complete the distal femoral resection.

Resect the distal femur.

Remove the Distal Femoral Cutting Block and Pins.



INFORMATION

If the canal ream has been extended to move from a straight to offset stem, the angle of the distal cut should be revisited using these instruments to ensure it has not been affected by the axis of the deeper canal ream.

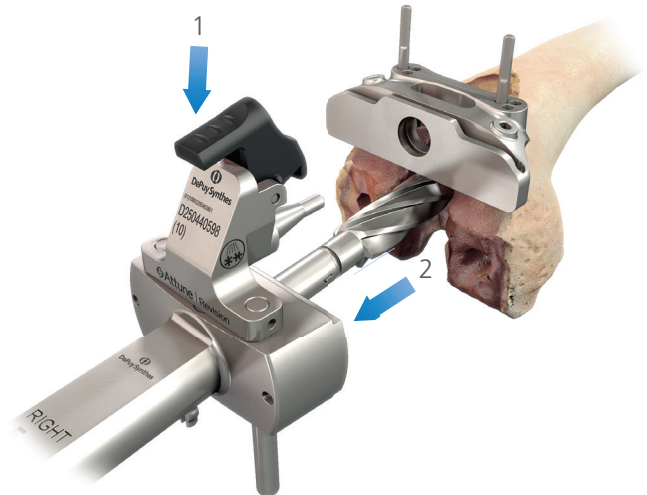
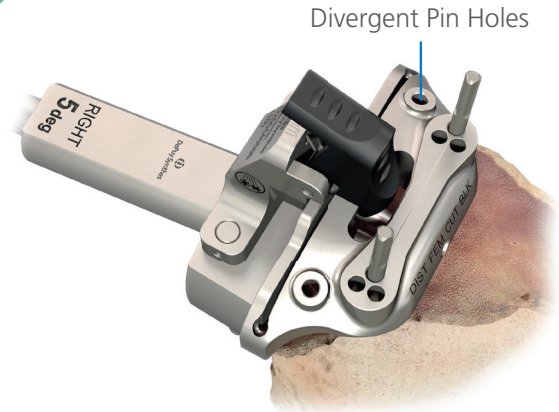

Femoral Preparation

Sizing the Femur



Cut Through Trial



Conventional Cut Guide

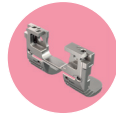

FE Guide



Straight Stem



Offset Stem



Femoral Sleeve and Stem

When sizing the femur, select the component that maximizes the femoral size while avoiding M/L overhang.

There are four suggested methods to assess the femoral size based on M/L dimension in addition to pre-operative templating:

- Place the Cut Through Trial Body over the distal femur
- Hold the Conventional Cut Guide against the distal femoral bone as the M/L width of the Conventional Cut Guide represents that of the Femoral Implant
- Hold the FE Guide against the distal femoral bone as the M/L width of the Cut Guide represents that of the Femoral Implant
- Place the Solid Femoral Trial backwards against the distal femur as the M/L width of the Femoral Trial represents that of the Femoral Implant

i INFORMATION

The Cut Through Trials and FE Guides are available in Sizes 3 - 10. The Conventional Cut Guide must be utilized to prepare femurs of Sizes 1 or 2.

i INFORMATION

If there is substantial bone loss, once the femoral size has been determined and the canal has been prepared, the Cut Through Trial may be assembled to the corresponding IM Connector, Boss Trial or Offset Adaptor Trial, Stem Trial Bolt and appropriate Stem Trial and inserted into the femoral bone.

The size 1 and 2 Conventional Cut Guide has a recessed portion which indicates the true MIL of the implant.

Proceed to Femoral Preparation through the Cut Through Trial on page 125.

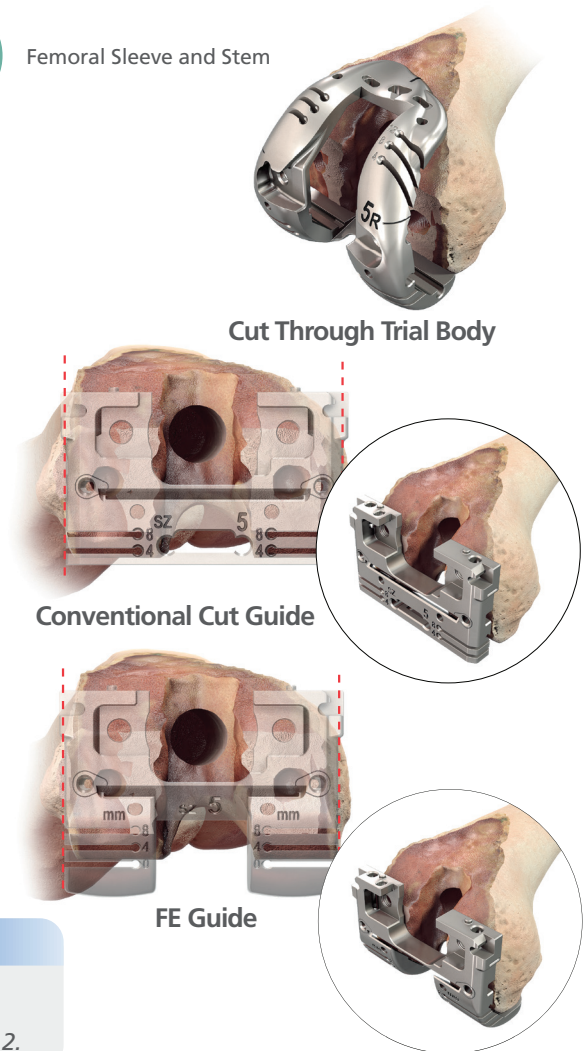

Solid Femoral Trial

Femoral Preparation

Setting Femoral Position



Conventional Cut Guide

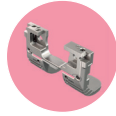

FE Guide



INFORMATION

*In order to utilize the **FE Guide** workflow there must be sufficient posterior condylar bone loss to allow the FE Guide to seat on the distal femoral bone as well as adjust rotation. If there is posterior condylar bone present such that it prohibits the seating of the FE Guide, either perform a manual posterior resection or proceed to the Conventional Cut Guide workflow.*

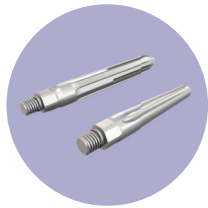

Straight Stem
Proceed to **page 81**

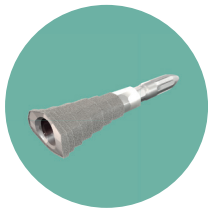

Femoral Sleeve and Stem
Proceed to **page 83**

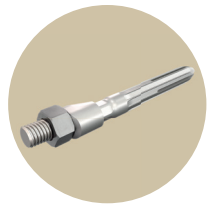

Offset Stem
Proceed to **page 91**

Femoral Preparation

Setting Femoral Position



Conventional Cut Guide

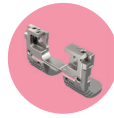

FE Guide



Straight Stem

This is the Intramedullary Preparation of the Revision Femoral component with a Press-Fit or long Cemented Stem.

Once the definitive Reamer diameter has been determined, assemble the:

1. Conventional Cut Guide or FE Guide to IM Adaptor with the Hex Attachment.

Ensure that the correct "Right or Left" marking is facing upward on the IM Adaptor when assembled to the Conventional Cut Guide or FE Guide.

2. Stem Stabilizer to the IM Adaptor by aligning the triangular feature on the Adaptor to the corresponding features on the Stem Stabilizer and turning the lock barrel of the IM Adaptor to tighten to the Stem Stabilizer.

3. Stem Trial to the Stem Stabilizer.

Ensure that the correct "Right or Left" marking is facing upward on the IM Adaptor when assembled to the Conventional Cut Guide or FE Guide.

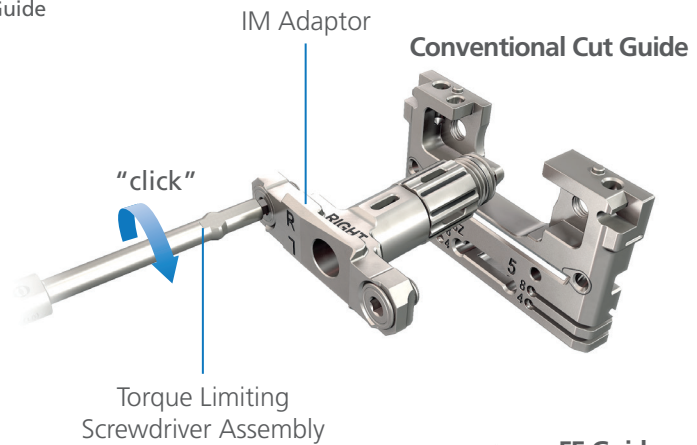

Torque Limiting Screwdriver Assembly

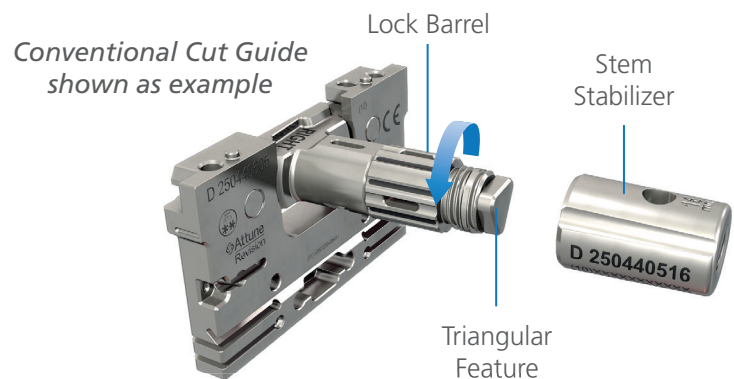

Femoral Preparation

Setting Femoral Position



Conventional Cut Guide

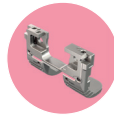

FE Guide



Straight Stem

Introduce the Conventional Cut Guide or FE Guide Assembly into the femoral bone. If impaction is necessary, the Revision System Handle must be attached to the IM Adaptor and used to gently seat the assembly. The Conventional Cutting Guide or FE Guide should not be impacted directly.

Ensure that the construct is stable in the canal.

Please note that the Stem attached to the Conventional Cut Guide and FE Guide constructs are designed to provide support and therefore the Stem length will not be identical to all of the variable Final Trial constructs. The IM Adaptor length is designed to align with the middle of the femoral box groupings (Sizes 4 - 7) to reduce complexity within the system, and is 4 mm shorter than the largest grouping (Sizes 8 - 10).

The markings on the Reamer Reference Tools are positioned for the femoral canal to be prepared to the longest of the femoral box groupings (Sizes 8 - 10) to ensure the canal is prepared for the final Implant of all size groupings.

For Gap Balancing and Setting Rotation with a Straight Stem, proceed to **page 94**.

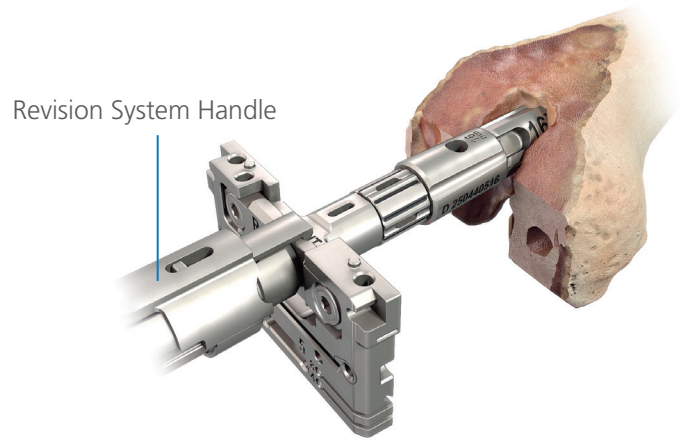

Revision System Handle

Conventional Cut Guide

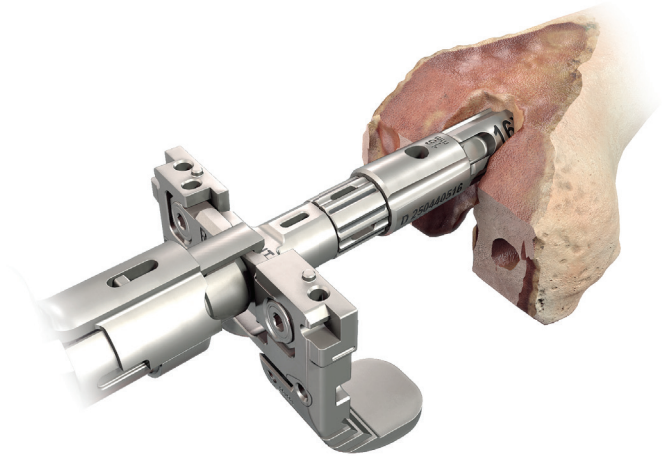

FE Guide



INFORMATION

The Stem Stabilizers are tapered and measure 1 mm larger in diameter at the distal end and taper to be equivalent to the comparable Stem Trial at the proximal end. If necessary, to avoid potential femoral fracture, the distal femoral canal may be opened with the next larger Canal Reamer to allow for introduction of the Stem Stabilizer, but care should be taken not to sink in the Reamer too far in the canal.

Stem Stabilizers are available in 14, 16, 18, 20, 22, and 24 mm sizes and should be chosen to correspond with the Stem diameter used but may be adjusted in order to provide stability in the canal.

Femoral Preparation

Femoral Sleeve and Stem



Conventional Cut Guide

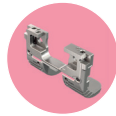

FE Guide



Femoral Sleeve and Stem

This is the Intramedullary Preparation of the Revision Femoral component with a Sleeve and Stem.

Attention should be paid to the entry point of the Canal Reamers and Broach as there is no ability to use an Offset Stem with a Femoral Sleeve.

Assemble the appropriately sized Stem Trial to the Femoral Broach Starter Reamer.

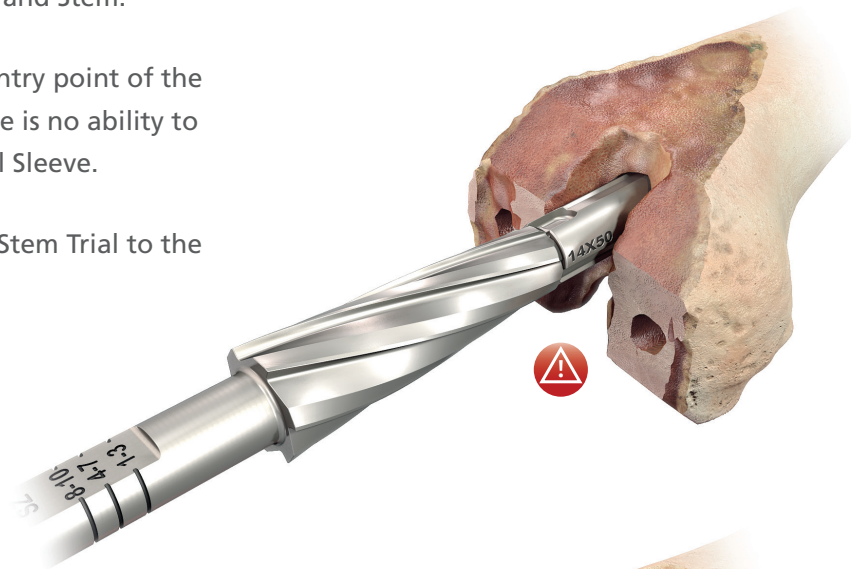

Seat the Femoral Broach Starter Reamer until the line of the appropriate femoral size grouping is level with the distal surface of the femur (or desired distal surface of the femur).

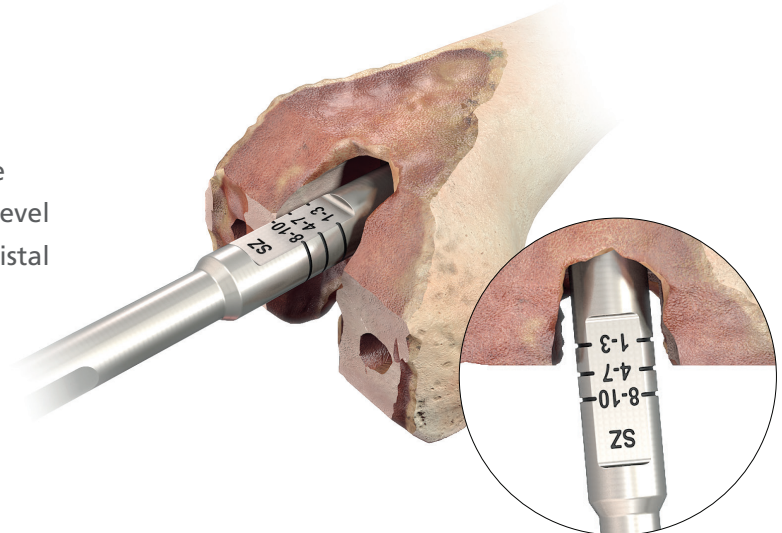

CAUTION

Do not reverse ream.

Femoral Preparation

Femoral Sleeve and Stem



Conventional Cut Guide

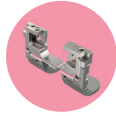

FE Guide



Femoral Sleeve and Stem

Assemble the corresponding Stem Trial to the smallest Femoral Broach.

If utilizing the KINCISE™ Surgical Automated System for broaching proceed to Appendix A on Page 219.

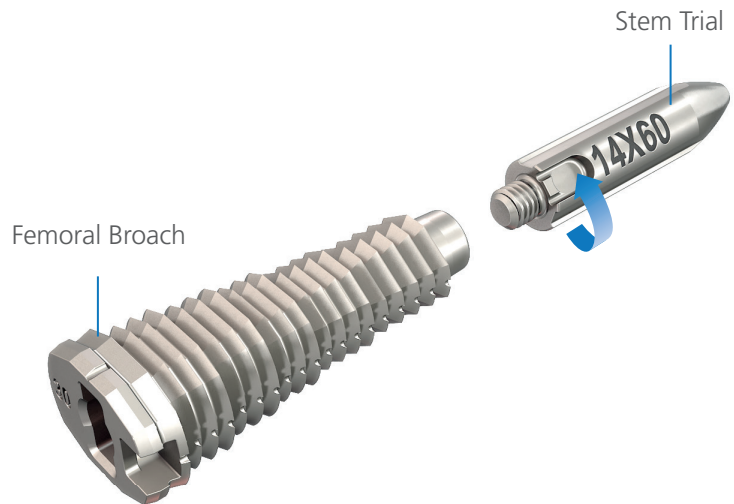

Connect the correct side, "Left or Right", Broach Stop of the appropriate size grouping, 1 - 3, 4 - 7, 8 - 10, to the Revision Broach Handle.

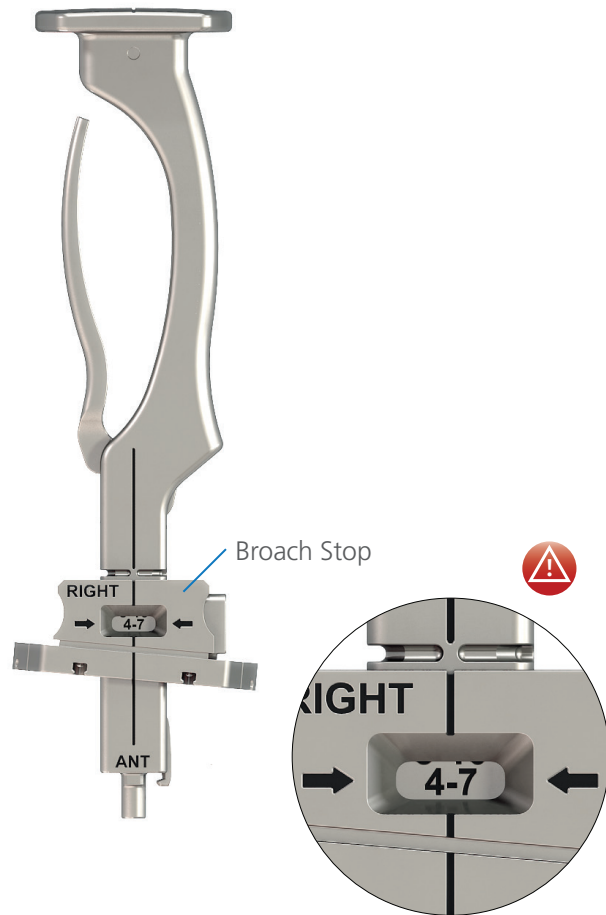

CAUTION

A Broach Stop must be utilized when broaching the femur.

Femoral Sleeve and Stem



Conventional Cut Guide

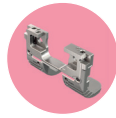

FE Guide



Femoral Sleeve and Stem

Connect the Broach Assembly to the Broach Handle Assembly and introduce to the reamed femoral canal.

Care should be taken to maintain a posterior positioning of the Broach to aid in posteriorizing the Femoral Component as a means for filling the flexion gap. Additionally the anterior flat surface of the Broach and Broach Stop should be rotated to the anticipated rotation of the Femoral Component to maximize Femoral to Sleeve compatibility. See chart on **Page 87** for rotational allowance between Broaches/Sleeves and the Femoral Component.

Two additional tools to aid in placement of the Femoral Broach include:

- Broach Stop Shims available in 4, 8, 12, 16 mm, representative of the Distal Augment thicknesses in the system. If it is intended to have differing Augment thicknesses medial to lateral, then the Broach Stop Shim utilized will represent the thinner of the two intended Distal Augments. Additionally, Broach Stop Shims may be added to aid in leaving the Broach proud to allow for future adjustment when assessing extension gap
- Distalizing Gauge to aid in assessing the proximal - distal position relative to the level of the epicondyles

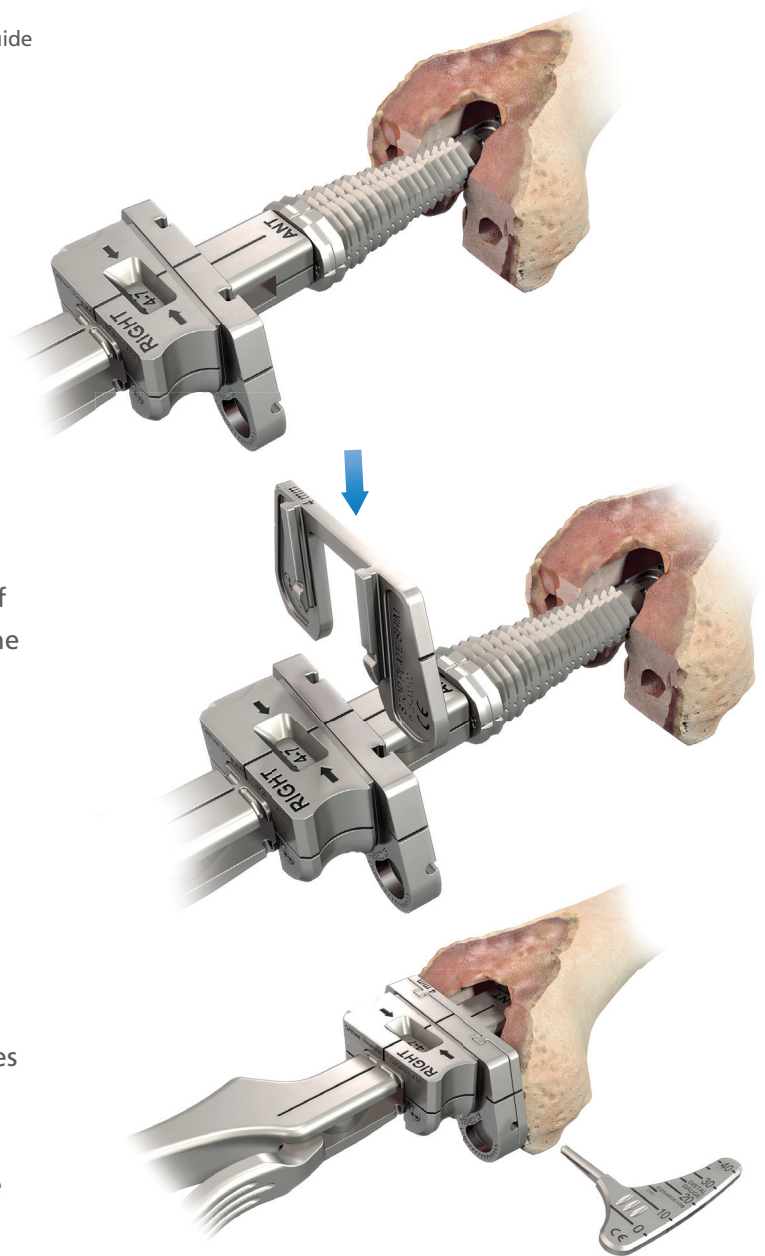

INFORMATION

If within a size 1, 2, or 3 femoral size, use the 30 mm Femoral Broach for canal fixation when preparing the distal femur. If a larger Femoral Sleeve is required, these femoral sizes (1, 2, or 3) are only compatible with up to a 35 mm Femoral Sleeve per the chart on page 87, however, no rotation is allowed.

Femoral Preparation

Femoral Sleeve and Stem



Conventional Cut Guide

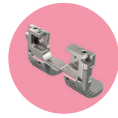

FE Guide



Femoral Sleeve and Stem

Advance the Broach until the Broach Stop, or Broach Stop Shim, is contacting the most prominent aspect of the distal femur. If there is significant bone loss on the distal femur, consider putting Broach Stop Shims on the Broach Stop to aid in replicating the expected joint line while broaching.

Check that the Broach is rotationally stable. If not, progressively increase the Broach size until rotational stability is achieved.



Femoral Preparation

ATTUNE Revision Femoral Component to ATTUNE Revision Femoral Sleeve Compatibility Chart



Conventional Cut Guide

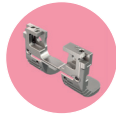

FE Guide



Femoral Sleeve and Stem

ATTUNE Revision Femoral Sleeve and ATTUNE Revision Femoral Component Compatibility*¹

		ATTUNE Revision Femoral Sleeve Size (mm)					
		30	35	40	45	50	55
ATTUNE Revision Femoral Component Size	1	X	X				
	2	X	X				
	3	X	X				
	4	X	X	X	X		
	5	X	X	X	X	X	X
	6	X	X	X	X	X	X
	7	X	X	X	X	X	X
	8	X	X	X	X	X	X
	9	X	X	X	X	X	X
	10	X	X	X	X	X	X



* Clearance between the ATTUNE Revision Femoral Component and ATTUNE Revision Femoral Sleeve was assessed at nominal conditions.

The distance between the distal most anterior aspect of the Sleeve and the inside of the anterior flange limits the amount of rotation possible before impingement of the Sleeve on the implant. The "X"s in the table above indicate recommended compatibility.

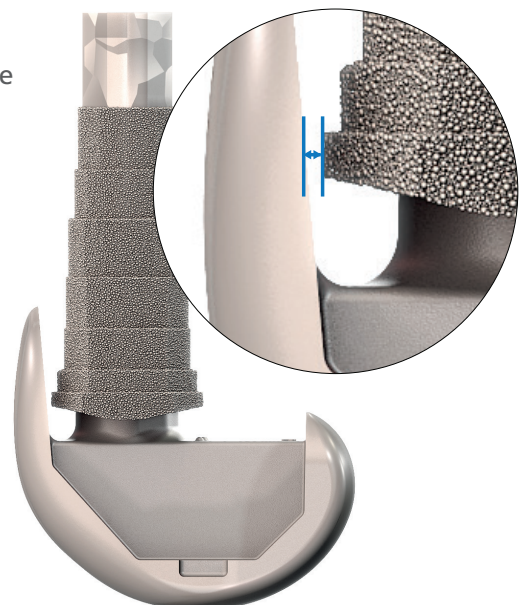

CAUTION

For the seven highlighted scenarios in the Chart, there is less than 10 degrees of rotational freedom. Caution is recommended when broaching the femur with these component combinations.

Femoral Preparation

For Femoral Sizes 1 - 3



Conventional Cut Guide

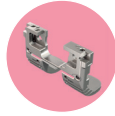

FE Guide



Femoral Sleeve and Stem

If after reviewing the chart, the patient anatomy requires a 35 mm Femoral Sleeve, use the 30 mm Femoral Broach for canal fixation when preparing the distal femur. After completing the bone preparation and assembling the Femoral Trial, transcribe the lines on the medial and lateral sides of the Femoral Trial on to the distal femur and utilize the corresponding marks on the sides of the Broach Handle and Broach Stop to position the final, 35 mm Femoral Broach, thus ensuring that the rotation of the Broach closely matches the rotation of the trial.

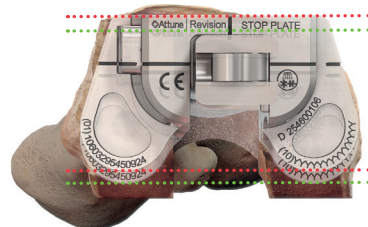
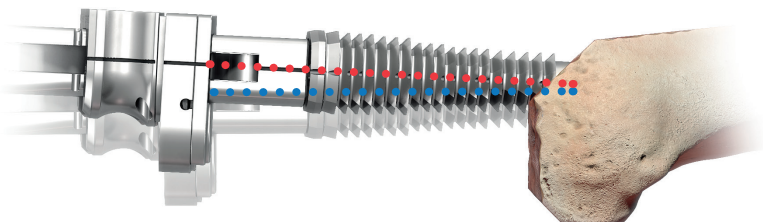
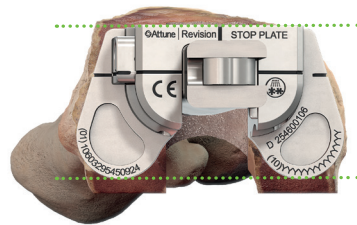
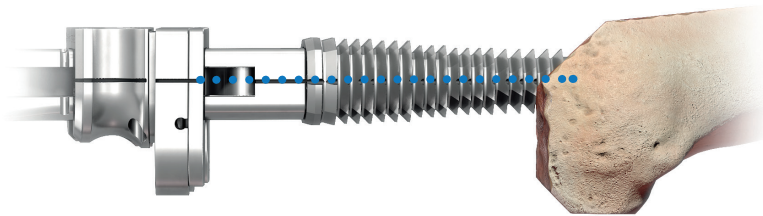
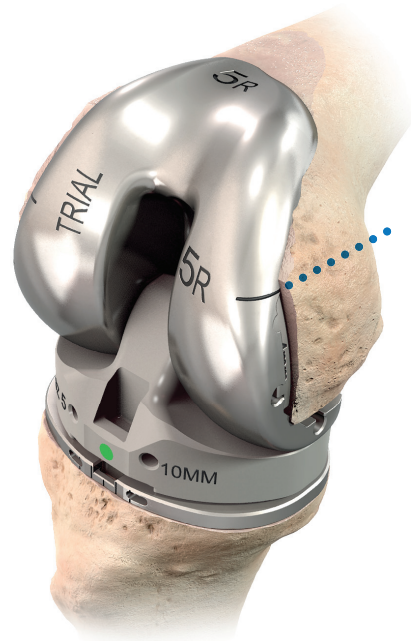

Femoral Preparation

Distal Clean-up Resection



Conventional Cut Guide

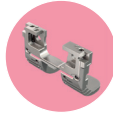

FE Guide



Femoral Sleeve and Stem

If desired, once rotational stability and the corresponding Broach size are achieved, a distal clean-up resection may be performed using the proximal surface of the Broach Stop or Broach Stop Shim, if used. If a resection is performed, reseal the Broach.

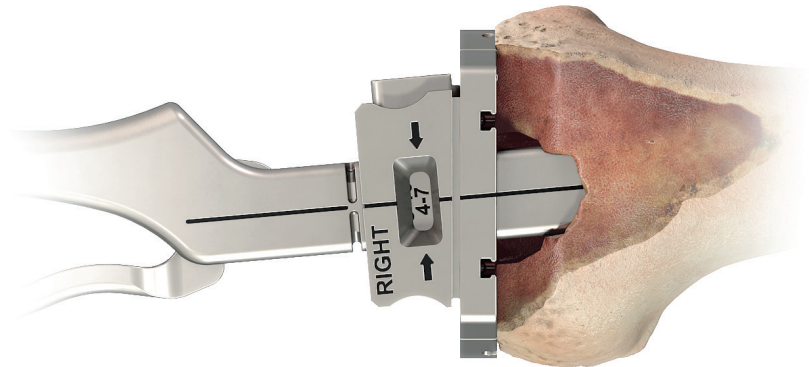
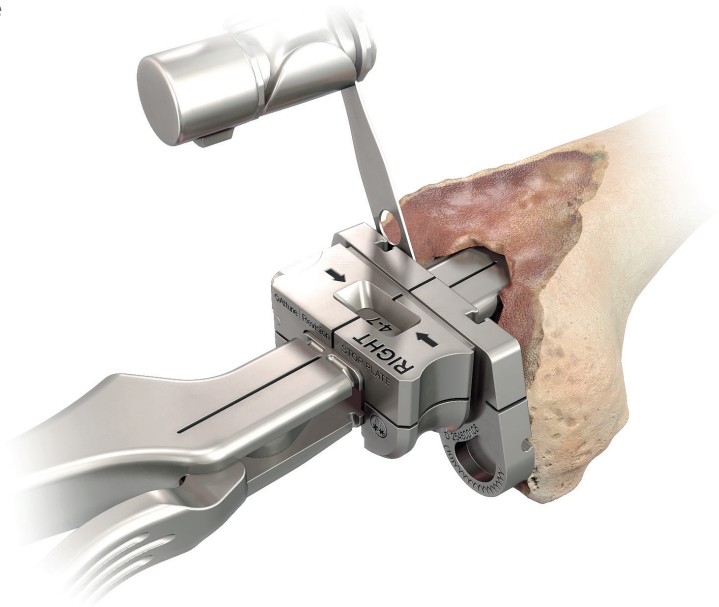

Disconnect the Broach Handle from the Femoral Broach, leaving the Femoral Broach in the bone.

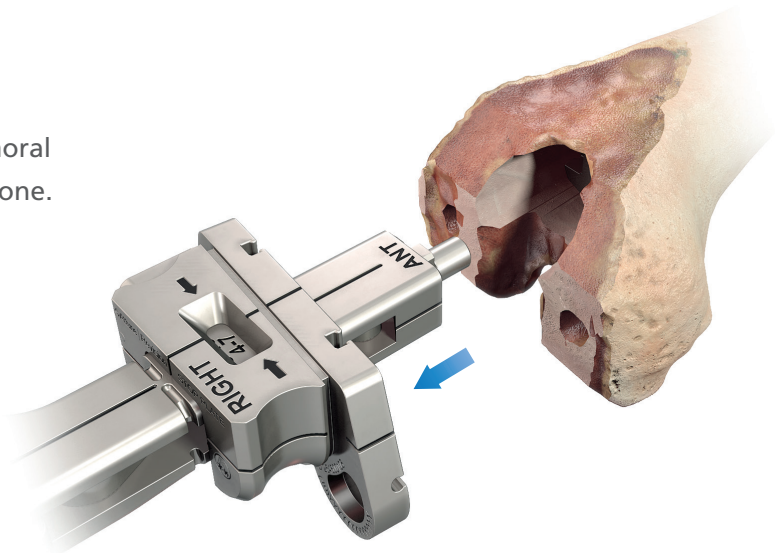

Femoral Preparation

Broach Adaptor Assembly



Conventional Cut Guide



Femoral Sleeve and Stem

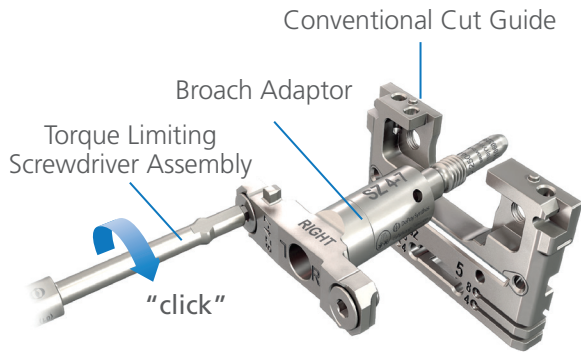

Assemble the appropriate size (1 - 3, 4 - 7, or 8 - 10) Broach Adaptor to the appropriately sized Conventional Cut Guide ensuring that the correct orientation, Right or Left, are legible.

Tighten using the Torque Limiting Screwdriver Assembly.

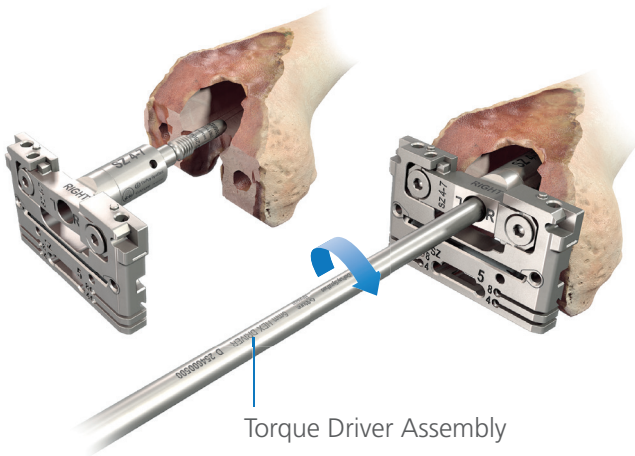

Using the Torque Driver and the 6 mm Hex Driver, assemble the Conventional Cut Guide Assembly to the Broach in the prepared femur.

For Gap Balancing and Setting Rotation with a Sleeve when utilizing the Conventional Cut Guide, proceed to **page 94**.

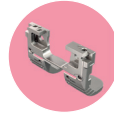

FE Guide



Femoral Sleeve and Stem

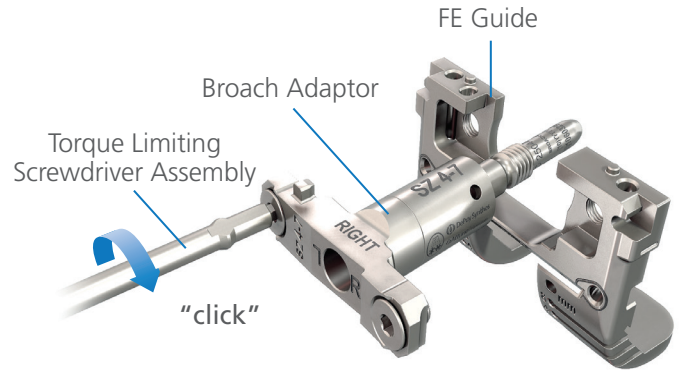

Assemble the appropriate size (1 - 3, 4 - 7, or 8 - 10) Broach Adaptor to the appropriately sized FE Guide ensuring that the correct orientation, Right or Left, are legible.

Tighten using the Torque Limiting Screwdriver Assembly.

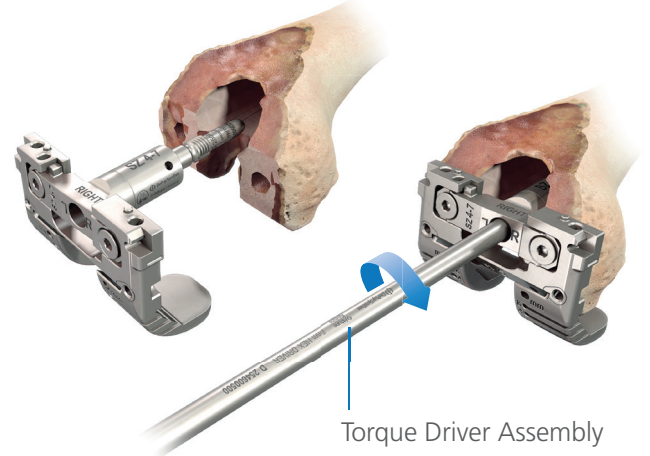

Using the Torque Driver and the 6 mm Hex Driver, assemble the FE Guide Assembly to the Broach in the prepared femur.

For Gap Balancing and Setting Rotation with a Sleeve when utilizing the FE Guide, proceed to **page 98**.

Femoral Preparation

Femoral Offset Preparation



Conventional Cut Guide

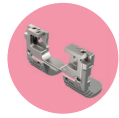

FE Guide



Offset Stem

This is the Intramedullary Preparation of the Revision Femoral Component with an Offset Adaptor and Press-Fit Stem.

Once the definitive Reamer diameter has been determined, and either the femoral canal is determined to be offset from the distal femur or offset is desired to address the flexion gap, proceed with utilizing the Femoral Offset Instrumentation.

Please note, the Offset Adaptor adds an additional 25 mm to the overall implant construct length. However, the Conventional Cut Guide with the Offset Assembly has a construct length appropriate for a Straight Stem. This allows the evaluation of offset without having to increase the ream depth.

If the original ream depth was determined based on a Straight Stem assumption, once it is determined that an offset is required, then ensure that the ream depth is increased to be appropriate for an offset construct.

Approximate the magnitude of offset required (2 mm, 4 mm or 6 mm) based on M/L canal offset or desired flexion gap A/P compensation.



INFORMATION

If intraoperatively transitioning from preparing for a straight Press-Fit Stem to an Offset Press-Fit Stem, it is recommended to revisit the distal femoral resection (Page 76) to ensure the Conventional Cut Guide or FE Guide will remain on axis with the femoral canal.

Femoral Offset Guides are not compatible with the size 1 Conventional Cut Guide.

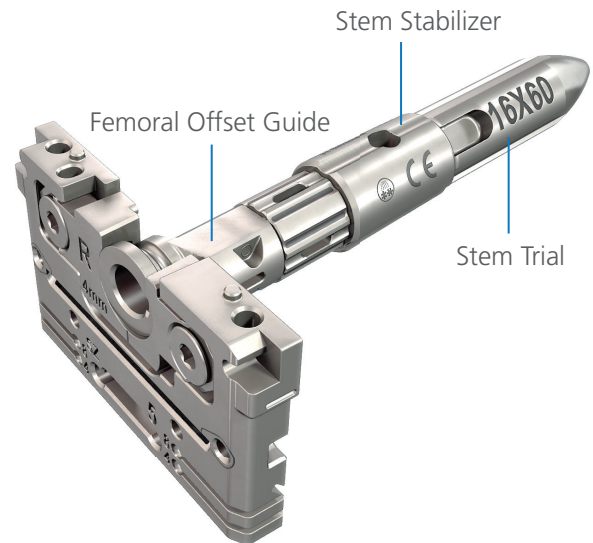

Conventional Cut Guide

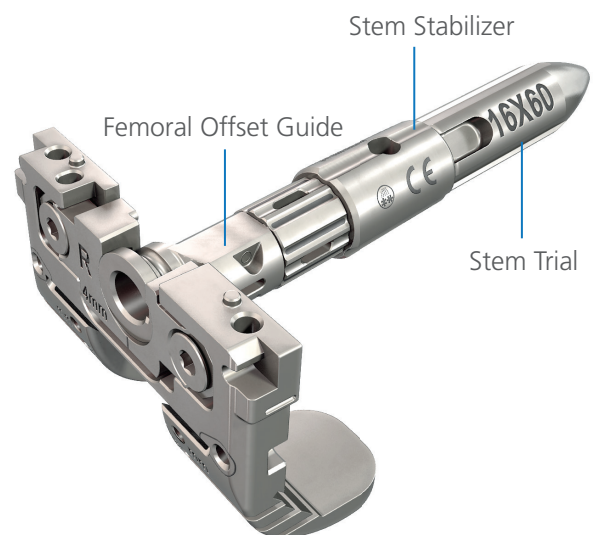

FE Guide

Femoral Preparation

Femoral Offset Preparation

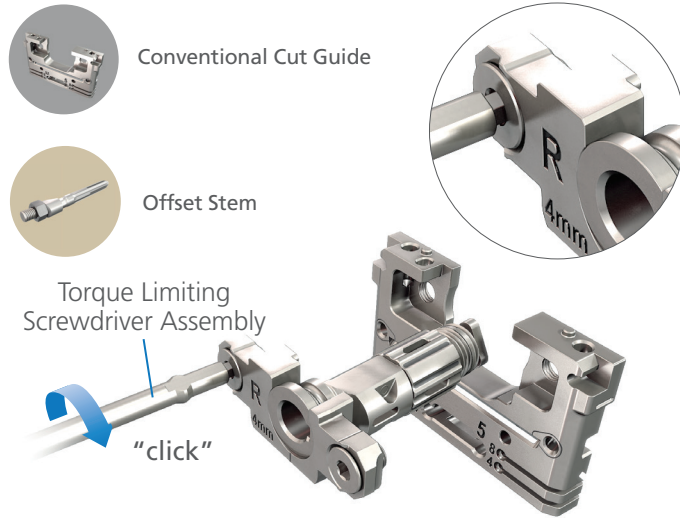

Assemble the corresponding:

1. Conventional Cut Guide to Femoral Offset Guide with the Hex Attachment. Ensure that the correct "Right or Left" marking is facing upward on the Femoral Offset Guide when assembled to the Conventional Cut Guide.

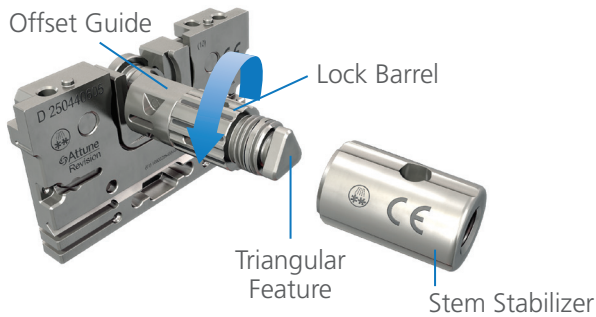

2. Stem Stabilizer to the Femoral Offset Guide by aligning the triangular feature on the Femoral Offset Guide to the corresponding features on the Stem Stabilizer and turning the Lock Barrel of the Femoral Offset Guide to tighten to the Stem Stabilizer.



3. Stem Trial to the Stem Stabilizer.

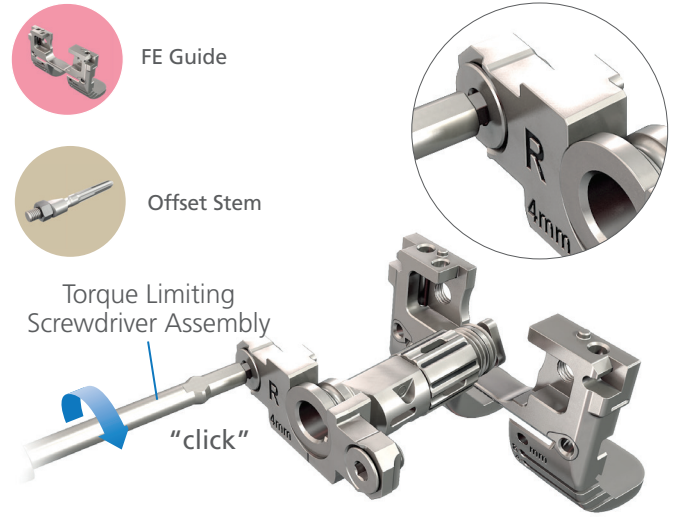

Assemble the corresponding:

1. FE Guide to Femoral Offset Guide with the Hex Attachment. Ensure that the correct "Right or Left" marking is facing upward on the Femoral Offset Guide when assembled to the FE Guide.

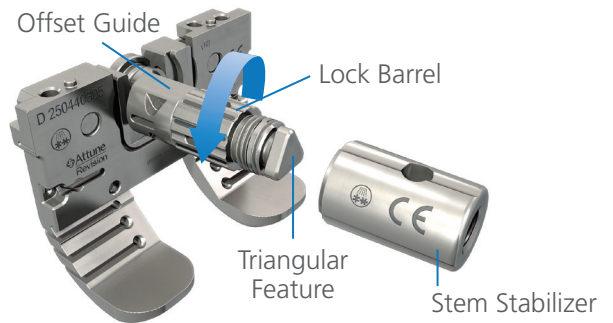

2. Stem Stabilizer to the Femoral Offset Guide by aligning the triangular feature on the Femoral Offset Guide to the corresponding features on the Stem Stabilizer and turning the Lock Barrel of the Femoral Offset Guide to tighten to the Stem Stabilizer.



3. Stem Trial to the Stem Stabilizer.

Femoral Preparation

Femoral Offset Preparation



Conventional Cut Guide

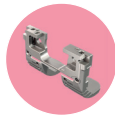

FE Guide



Offset Stem

Introduce the Conventional Cut Guide or FE Guide Assembly into the femoral bone. If impaction is necessary, the Revision System Handle must be attached to the Femoral Offset Guide and used to gently seat the assembly. The Conventional Cut Guide or FE Guide should not be impacted directly.

For Gap Balancing and Setting Rotation with the Conventional Cut Guide and Offset Stem, proceed to **page 94**.

For Gap Balancing and Setting Rotation with the FE Guide and Offset Stem, proceed to **page 98**.

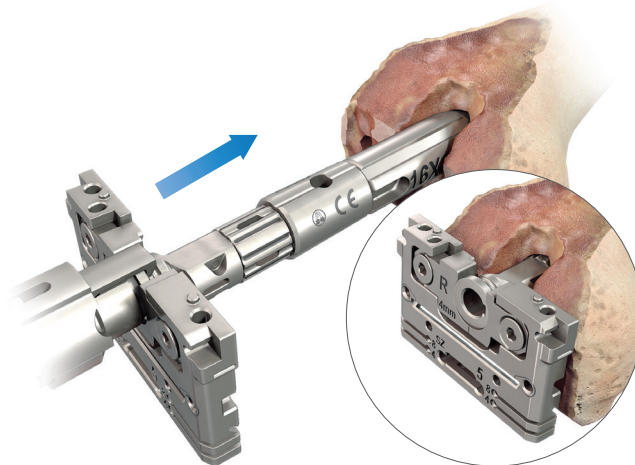

Conventional Cut Guide

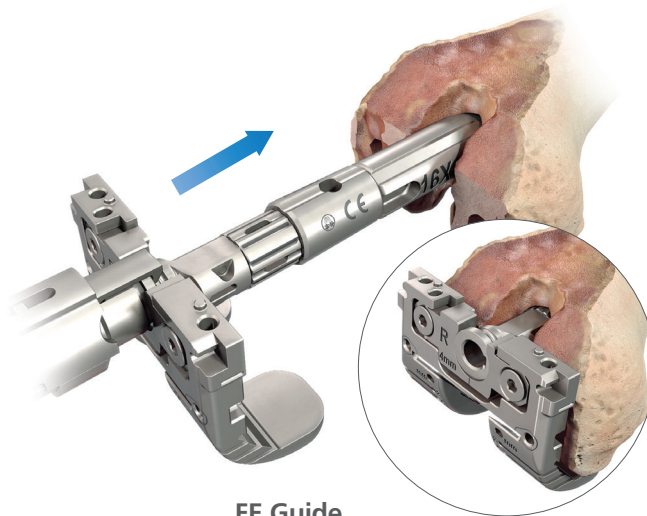

FE Guide



INFORMATION

The Stem Stabilizers are tapered and measure 1 mm larger in diameter at the distal end and taper to be equivalent to the comparable Stem Trial at the proximal end. If necessary, to avoid potential femoral fracture, the distal femoral canal may be opened with the next larger Canal Reamer to allow for introduction of the Stem Stabilizer, but care should be taken not to sink in the Reamer too far in the canal.

Stem Stabilizers are available in 14, 16, 18, 20, 22, and 24 mm sizes and should be chosen to correspond with the Stem diameter used but may be adjusted in order to provide stability in the canal.

Femoral Preparation

Initial Flexion Gap Assessment



Conventional Cut Guide



Straight Stem



Offset Stem



Femoral Sleeve and Stem

The general approach in this surgical technique is to do an initial assessment of Flexion and Extension Gaps, adjust Extension Gap if required, and then establish the final Flexion Gap and Set Femoral Rotation.

The ATTUNE Revision Knee System provides two instrument options to balance the flexion gap with the Conventional Cut Guide: Spacer Block and Femoral Positioner, both of which are to be used with the Spacer Block Shims.



Introduce the preferred balancing tool and set rotation and balance the flexion gap.

To gap balance with a Femoral Broach in place, slightly loosen the Central Bolt in the Broach Adaptor to allow rotation.

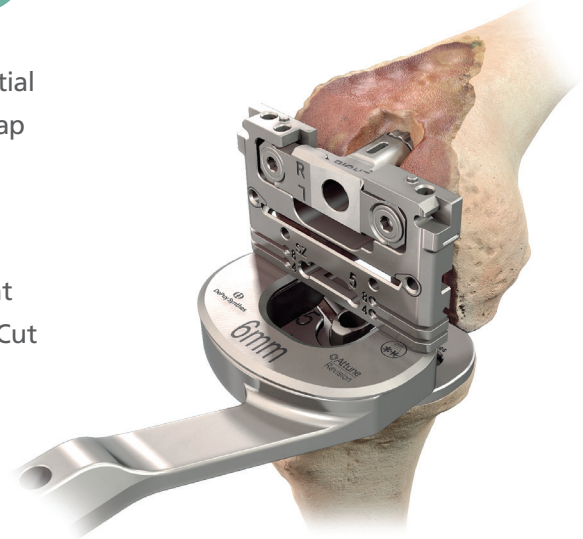

Revision Spacer Block



Femoral Positioner



CAUTION

The ATTUNE Revision Spacer Block and Spacer Block Shims cannot be used interchangeably with the ATTUNE Primary INTUITION Spacer Block and Shims.

Femoral Preparation

Initial Flexion Gap Assessment



Conventional Cut Guide



Straight Stem



Offset Stem



Femoral Sleeve and Stem

- Spacer Block

- Femoral Positioner

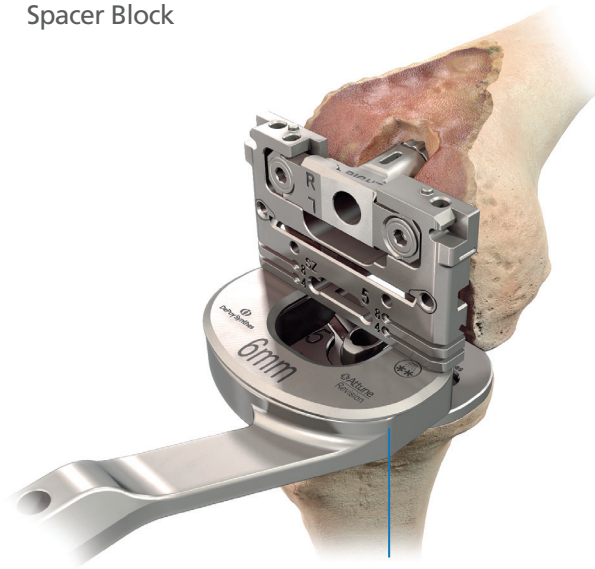

Use thick end for flexion



The thick end of the Revision Spacer Block is only utilized in flexion, resting on the Tibial Trial and against the posterior aspect of the Conventional Cut Guide as this accounts for the thickness of the posterior condyles of the Femoral Implant. The thin end will be utilized to assess extension.

The Femoral Positioner connects to the Conventional Cut Guide for a secure rotational balance with respect to the tibial plateau, and may be especially helpful when preparing the femur for an Offset Stem. If the posterior femoral bone contacts the Femoral Positioner, it may limit rotation.

Revision Tibial Inserts are available in 2 mm increments (6 - 26 mm). The Revision Femoral Component is also designed to articulate with the PS Tibial Inserts available in 1 mm increments (5 - 8 mm) and 2 mm increments (10 - 20 mm). For establishing Extension Gap using a Straight Stem or Sleeve proceed to **page 97**, for Offset Stems proceed to **page 96**.

i INFORMATION

To assess for the 5 or 7 mm PS Tibial Inserts, the ATTUNE Primary INTUITION Spacer Block Handle and Shims must be utilized and the Revision Tibial Base Trial must be removed from the joint space.

Femoral Preparation

Initial Flexion Gap Assessment



Conventional Cut Guide



Offset Stem

Attach the Anterior Cutting Guide to the Conventional Cut Guide and introduce the Angel Wing to assess the anterior resection. 

Use the Torque Limiting Screwdriver Assembly to adjust the femoral offset while assessing ligament tension, anterior resection, and M/L fit.

The surgeon should use their preferred method to assess the balance and flexion gap. Options available within the Revision Instrument System include using the Revision Spacer Block, the Femoral Positioner or visual landmarks.

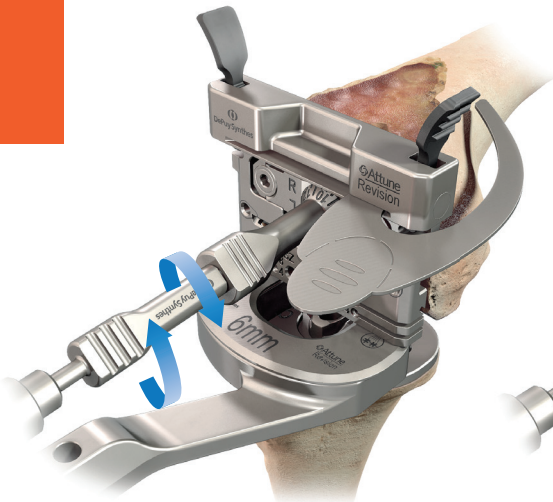
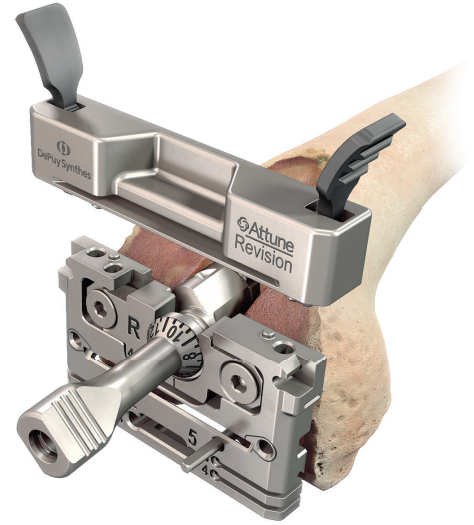

Revision Spacer Block

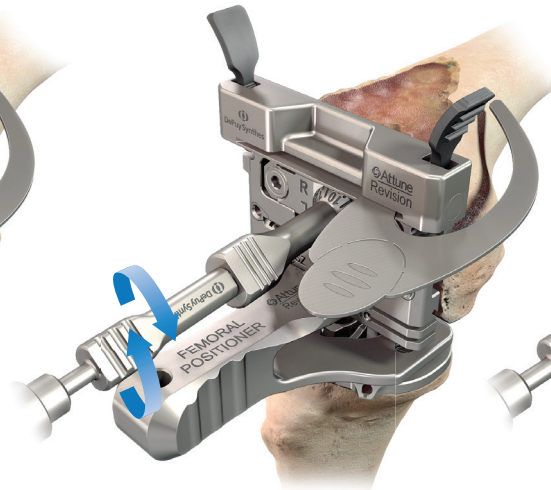

Femoral Positioner

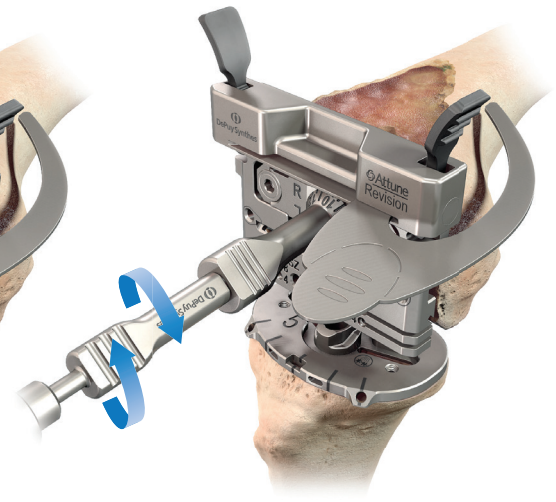

Visual Landmarks



CAUTION

The surgeon may want to support the thigh as the offset is being adjusted in order to allow for tensioning of the joint space not to be impacted by the weight of the leg.

Femoral Preparation

Initial Extension Gap Assessment



Conventional Cut Guide



Straight Stem



Offset Stem



Femoral Sleeve and Stem

Remove the flexion gap assessment tools and place the knee into extension. Move the final Spacer Block Shim utilized to assess flexion to the **thin end** of the Revision Spacer Block and introduce into the extension space.

Place the Spacer Block in the extension joint space between the distal surface of the Conventional Cut Guide and the top of the Tibial Base Trial.

Optionally, if exposure permits, the Distalizing Gauge may be utilized to provide an additional reference to the epicondyles.

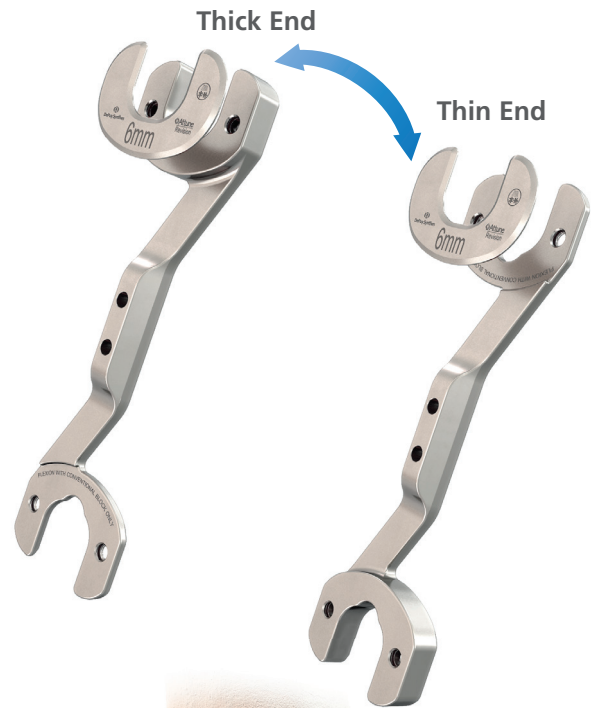

i INFORMATION

The Conventional Cut Guide is 9 mm thick to replicate the distal thickness of the definitive Femoral Implant.

Femoral Preparation

Initial Flexion Gap Assessment

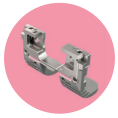

FE Guide



Offset Stem



Straight Stem



Femoral Sleeve and Stem

The general approach in this surgical technique is to do an initial assessment of Flexion and Extension Gaps, adjust Extension Gap if required, and then establish the final Flexion Gap and Set Femoral Rotation.

With the knee in flexion, introduce the **thin end** of the Revision Spacer Block Handle with Shims. Utilize the Angel Wing to assess the projected anterior resection.



Note: Utilize the thin end of the Revision Spacer Block Handle to assess both extension and flexion with the FE Guide as the feet of the FE Guide represent the posterior condyles of the Femoral Implant and the distal thickness of the FE Guide represents the distal Femoral Implant thickness.



IM Adaptor Depicted

Revision Tibial Inserts are available in 2 mm increments (6 - 26 mm).

The Revision Femoral Component is also designed to articulate with the PS Tibial Inserts available in 1 mm increments (5 - 8 mm) and 2 mm increments (10 - 20 mm).

Attach the Anterior Cutting Guide to the FE Guide and introduce the Angel Wing to assess the anterior resection.

For Straight Stem or Sleeve workflows, proceed to **page 100**.

For Offset Stems proceed to **page 99**.



INFORMATION

To assess for the 5 or 7 mm PS Tibial Inserts, the ATTUNE Primary INTUITION Spacer Block Handle and Shims must be utilized and the Revision Tibial Base Trial must be removed from the joint space.



CAUTION

The Spacer Block Shims differ from the ATTUNE Primary INTUITION Shims used with the Primary Spacer Block. These cannot be used interchangeably.

The Spacer Block Shims have a different connection method and thickness than the ATTUNE Primary INTUITION Shims.

Femoral Preparation

Initial Flexion Gap Assessment with Offset Stem

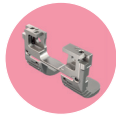

FE Guide



Offset Stem

Introduce the Femoral Offset Dial to the Femoral Offset Guide.

Use the Torque Limiting Screwdriver Assembly and Femoral Offset Dial to adjust the femoral offset while assessing ligament tension, anterior position, and M/L fit.

Note the preliminary offset position from alignment of the number on the Femoral Offset Guide and Dial with the etch line on the FE Guide. This will be used to set the initial offset position on the Trial.

For initial Extension Gap assessment, proceed to [page 100](#).

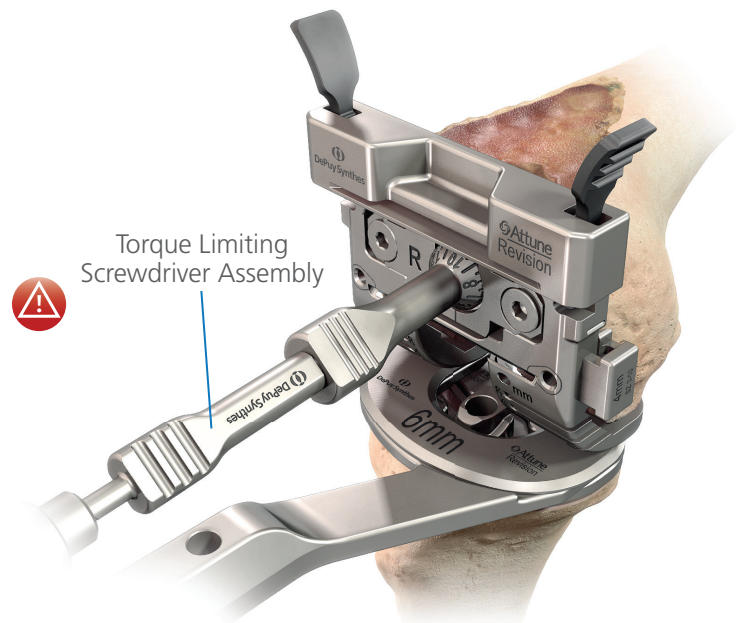

Torque Limiting Screwdriver Assembly



CAUTION

The surgeon may want to support the thigh as the offset is being adjusted in order to allow for tensioning of the joint space to not be impacted by the weight of the leg.



INFORMATION

The 6 o'clock position of the Femoral Offset Guide places FE Guide in the most posterior position which will enable the initial position of the Offset Stem to avoid interference between the FE Guide Feet and any posterior condylar bone.

Femoral Preparation

Initial Extension Gap Assessment

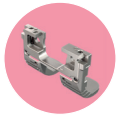

FE Guide



Offset Stem



Straight Stem



Femoral Sleeve and Stem

Once the desired flexion gap has been achieved, with the Revision Spacer Block Assembly retained in the joint space, gently take the knee into extension and proceed to assess the extension gap.

Distal Spacers may be added to the sides of the FE Guide to aid in maintaining desired femoral position during assessment of either flexion or extension.

Return the knee to flexion.

For Balancing Flexion and Extension Gaps proceed to **page 101**.



Femoral Offset Guide Depicted

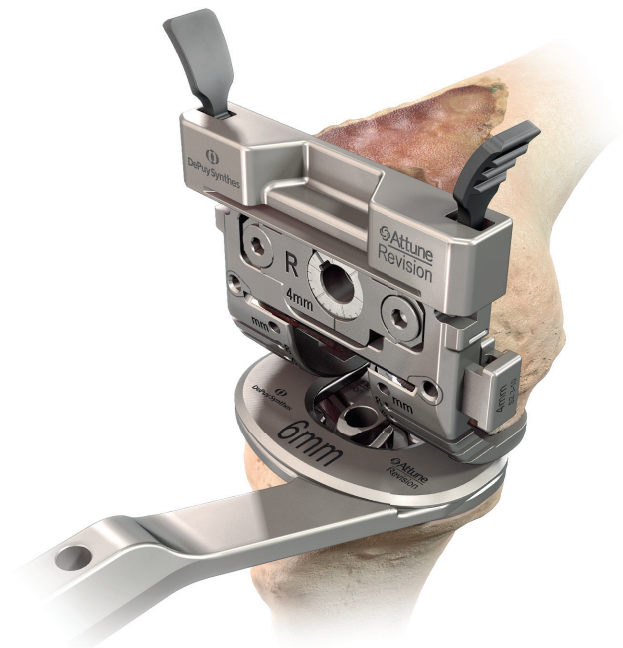

Femoral Offset Guide Depicted

Femoral Preparation

Balance Flexion and Extension Gaps



Conventional Cut Guide

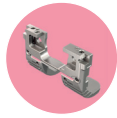

FE Guide



Straight Stem



Offset Stem



Femoral Sleeve and Stem

As the knee comes out to full extension, if the tension in the medial and lateral collateral ligaments is unequal, appropriate soft tissue releases should be performed in a manner to allow the tension to be equal on both the medial and lateral sides of the knee.

Should the selected joint line differ widely from the joint line anatomical markers, the surgeon has the ability to change the distal/proximal position of the Femoral Component but will have to mirror these changes with appropriate selection of the Tibial Insert and changes to the femoral sizing.

	Loose Extension	Stable Extension	Tight Extension
Loose Flexion	<p>Cause</p> <p>1. Flexion and extension gaps are too large.</p> <p>Possible Solution(s)</p> <ul style="list-style-type: none"> Increase Tibial Insert thickness Distalize and upsize the Femoral Component and add any necessary Distal Augments Assess if offset is appropriate to move the Femoral Component posteriorly to fill the flexion gap and add Distal Augments If Sleeve preparation: increase femoral Broach size, add Distal Augments, and upsize the Femoral Component 	<p>Cause</p> <p>1. Flexion gap is too large.</p> <p>Possible Solution(s)</p> <ul style="list-style-type: none"> Upsize Femoral Component Assess if offset is appropriate to move the Femoral Component posteriorly to fill the flexion gap and add any necessary Distal Augments Increase Tibial Insert thickness and resect more distal femur (re-evaluate A/P resections). Care should be taken to not raise the femoral position such that it results in patella baja 	<p>Cause</p> <p>1. Extension gap is too small and flexion gap is too large.</p> <p>Possible Solution(s)</p> <ul style="list-style-type: none"> Proximalize and upsize the Femoral Component by recutting the Distal Femur and adding any necessary Posterior Augments. Care should be taken to not raise the femoral position such that it results in patella baja Assess if offset is appropriate to move the Femoral Component posteriorly to fill the flexion gap, and decrease Tibial Insert thickness
Stable Flexion	<p>Cause</p> <p>1. Extension gap is too large.</p> <p>Possible Solution(s)</p> <ul style="list-style-type: none"> Distalize the Femoral Component and add any necessary Distal Augments 	<p>Desired ligament balance.</p>	<p>Cause</p> <p>1. Extension gap is too small.</p> <p>Possible Solution(s)</p> <ul style="list-style-type: none"> Proximalize the Femoral Component by recutting the distal femur (re-evaluate A/P resections). Care should be taken to not raise the femoral position such that it results in patella baja
Tight Flexion	<p>Cause</p> <p>1. Flexion gap is too small and extension gap is too large.</p> <p>2. Posterior osteophytes.</p> <p>Possible Solution(s)</p> <ul style="list-style-type: none"> Remove osteophytes if present Downsize Femoral Component and distalize the Femoral Component adding any necessary Distal Augments Assess if offset is appropriate to move the Femoral Component anteriorly to loosen the flexion gap. And reassess Insert thickness and Distal Femoral Augments 	<p>Cause</p> <p>1. Flexion gap is too small.</p> <p>2. Posterior osteophytes.</p> <p>Possible Solution(s)</p> <ul style="list-style-type: none"> Remove osteophytes if present Ensure that there is no soft tissue impingement Possibly downsize Femoral Component Distalize the Femoral Component using Distal Augments and decrease the Insert thickness Assess if offset is appropriate to move the Femoral Component anteriorly to loosen the flexion gap 	<p>Cause</p> <p>1. Flexion and extension gaps are too small.</p> <p>Possible Solution(s)</p> <ul style="list-style-type: none"> Decrease Tibial Insert thickness If the smallest Insert is still too tight, resect more tibia

For setting the Extension Gap with a Straight or Offset Stem proceed to **page 102**.

For setting the Extension Gap with a Sleeve and Stem proceed to **page 105**.

Femoral Preparation

Adjusting Extension Gap



Conventional Cut Guide



Straight Stem



Offset Stem

Take the knee into extension and utilize the **thin end** of the Revision Spacer Block Handle and Shims to assess the extension space. Allow the Cutting Guide Assembly to translate proximally or be manipulated distally in the femoral canal through the addition of Distal Spacers and establish the extension space that will then match the flexion space.

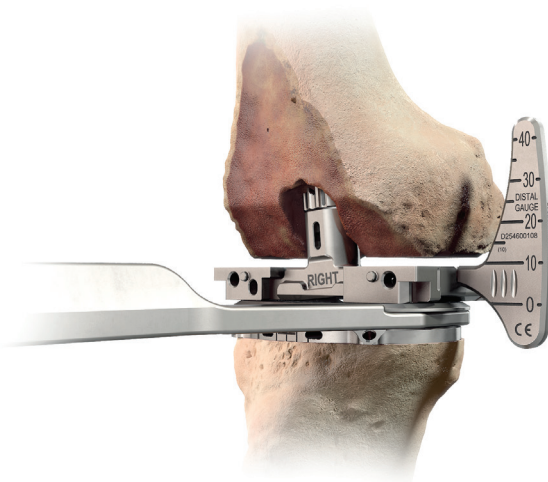

Remove the Spacer Block and return the knee to flexion. Optionally, if exposure permits, the Distalizing Gauge may be utilized to provide an additional reference to the epicondyles.

For Establishing the Flexion Gap and Setting Rotation with a Straight Stem proceed to **page 103**.

For Establishing the Flexion Gap and Setting Rotation with an Offset Stem, proceed to **page 104**.

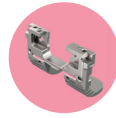

FE Guide



Straight Stem



Offset Stem

Take the knee into extension and utilize the **thin end** of the Revision Spacer Block Handle and Shims to assess the extension space. Allow the FE Guide Assembly to translate proximally or be manipulated distally in the femoral canal through the addition of Distal Spacers and establish the extension space that will then match the flexion space.

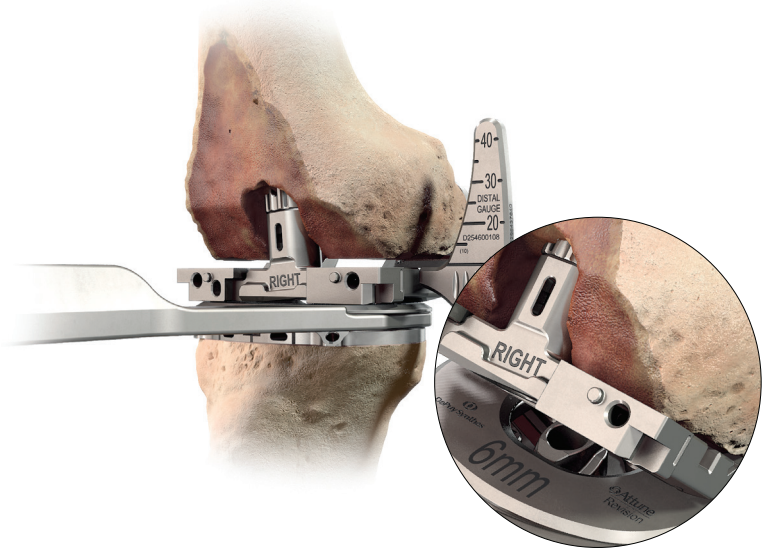

Leave the Spacer Block in the joint space and return the knee to flexion. Optionally, if exposure permits, the Distalizing Gauge may be utilized to provide an additional reference to the epicondyles.

For Establishing the Flexion Gap and Setting Rotation with a Straight Stem proceed to **page 103**.

For Establishing the Flexion Gap and Setting Rotation with an Offset Stem, proceed to **page 104**.

Femoral Preparation

Establishing the Flexion Gap and Setting Rotation



Conventional Cut Guide



Straight Stem

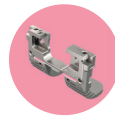

FE Guide



Straight Stem

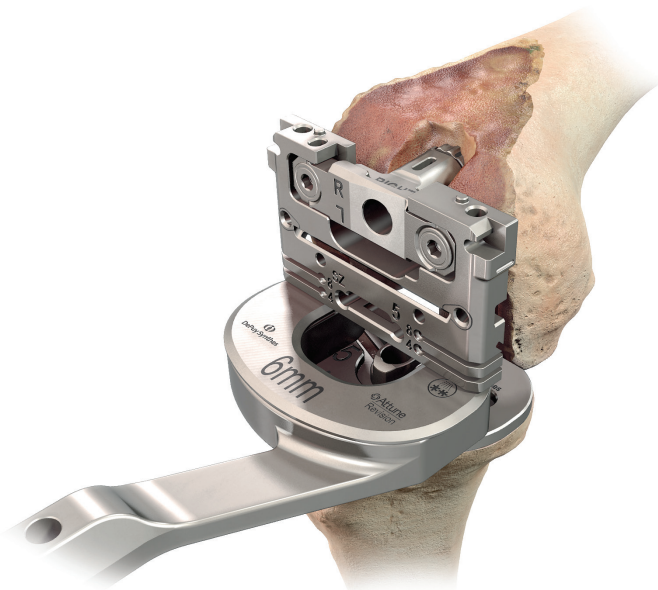

Balance the knee using the surgeon's preferred technique utilizing the **thick end** of the **Spacer Block** (per pages 95).

Set rotation and balance the flexion gap to match the extension gap.

Once the desired femoral position is achieved, pin the Conventional Cut Guide and proceed with Femoral Preparation.

For completing femoral resections with a Straight Stem, proceed to **page 109**.



Balance the knee using the surgeon's preferred technique utilizing the **thin end** of the **Spacer Block** (per page 98).

Set rotation and balance the flexion gap to match the extension gap.

Once the desired femoral position is achieved, pin the FE Guide and proceed with Femoral Preparation.

For completing femoral resections with a Straight Stem, proceed to **page 109**.

Femoral Preparation

Establishing the Flexion Gap and Setting Rotation



Balance the knee using the surgeon's preferred technique (per page 95). When the desired offset position has been achieved, pin the Conventional Cut Guide through the Parallel Pin Holes on the anterior face of the Guide.



Balance the knee using the thin end of the Spacer Block (per page 98). When the desired offset position has been achieved, pin the FE Guide through the Parallel Pin Holes on the anterior face of the Guide.

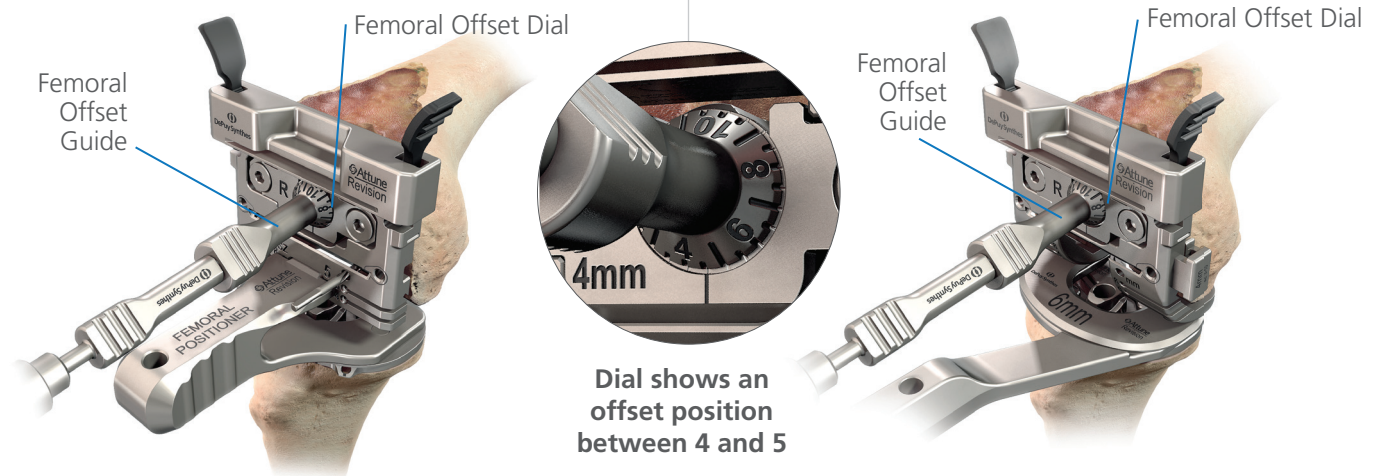

Note the preliminary offset position from alignment of the etch line/number on the Femoral Offset Dial with the engraved line on the Femoral Offset Guide. This will be used to set the initial offset position on the Trial.

Once pinned in place and offset position noted, proceed with Femoral Preparation.

For completing femoral resections with an Offset Stem, proceed to page 109.

Note the preliminary offset position from alignment of the etch line/number on the Femoral Offset Dial with the engraved line on the Femoral Offset Guide. This will be used to set the initial offset position on the Trial.

Once pinned in place and offset position noted, proceed with Femoral Preparation.

For completing femoral resections with an Offset Stem, proceed to page 109.

i INFORMATION

Consider using Threaded Non-Headed Pins for the Parallel Pins. The Parallel Pins allow for the Conventional Cut Guide or FE Guide to be translated distally to remove the Femoral Offset Guide Assembly from the construct and then the Guide to be repositioned back over the Parallel Pins to allow for further femoral preparation.

Femoral Preparation

Adjusting Extension Gap - Proximalizing the Femoral Position when using a Broach



Conventional Cut Guide

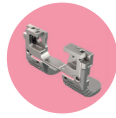

FE Guide



Femoral Sleeve and Stem

If the extension gap is tight, you may advance the Broach construct by assembling the System Handle to the Broach Adaptor and impacting the System Handle. 



Conventional Cut Guide Depicted



FE Guide Depicted



CAUTION

Do not advance the Broach by hitting the Cutting Block.

Femoral Preparation

Adjusting Extension Gap



Conventional Cut Guide

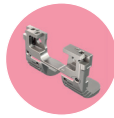

FE Guide



Femoral Sleeve and Stem

Distalizing the Femoral Position when utilizing a Broach (Optional)

Femoral Sleeves are designed to not only fill bone voids, but also to aid in distalizing the Femoral Component in the case of a loose extension gap. This can be achieved through upsizing the Broach used, as each size has an identical proximal geometry to the previous size, but grows distally by 4 mm.

For example, if after broaching for a 30 mm Sleeve, it is determined that the extension gap is loose, the 4 mm Broach Stop Shim can be added to the Broach Handle and then re-broach using the next size larger Broach (35 mm).

Adding the 4 mm Broach Stop Shim will distalize the Femoral Component by 4 mm, and upsizing a Broach/Sleeve size will ensure that the Broach sits in the original depth location in the femur but has extended distally by 4 mm.

If it is desired to distalize the extension gap by less than 4 mm, simply decrease the Broach Stop Shim by 4 mm and impact the Broach further, but not far enough to seat the Broach Stop as this will return to the original loose extension gap.

Disconnect the Broach Handle Assembly leaving the new Broach in position.

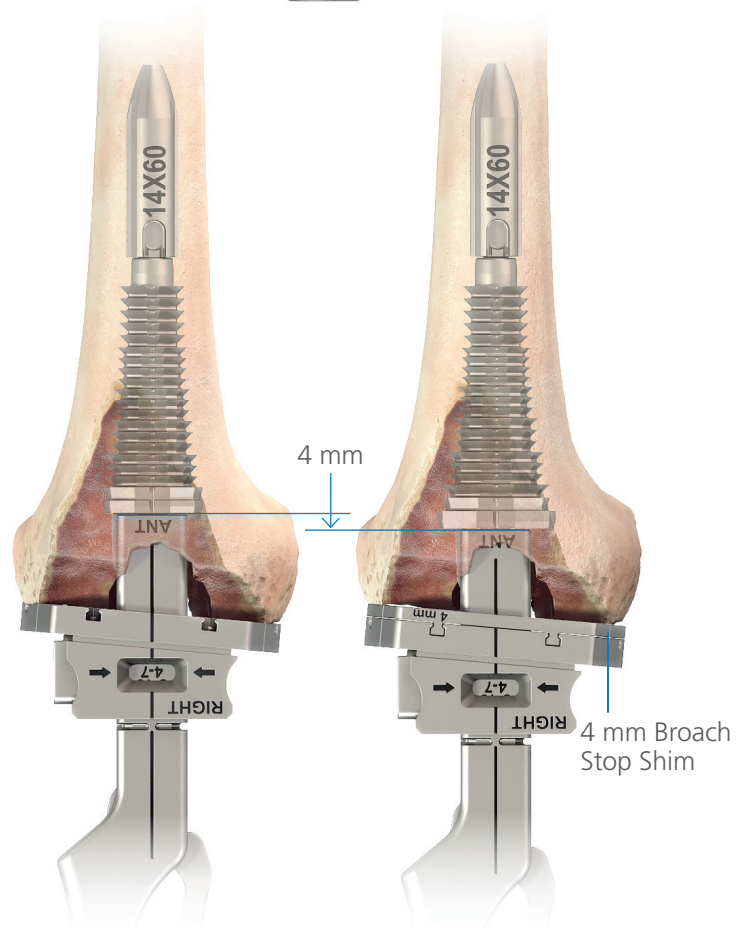
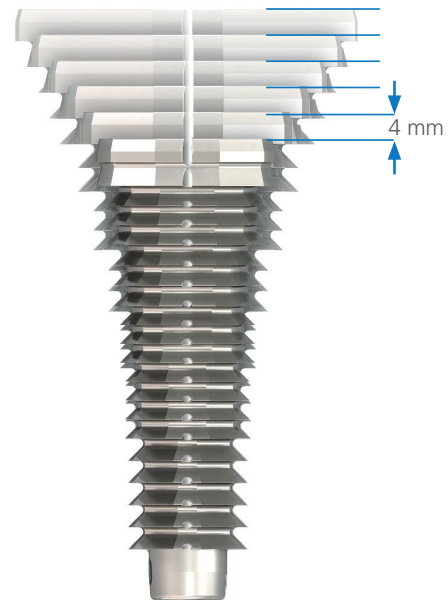

Femoral Preparation

Adjusting Extension Gap



Conventional Cut Guide



Femoral Sleeve and Stem

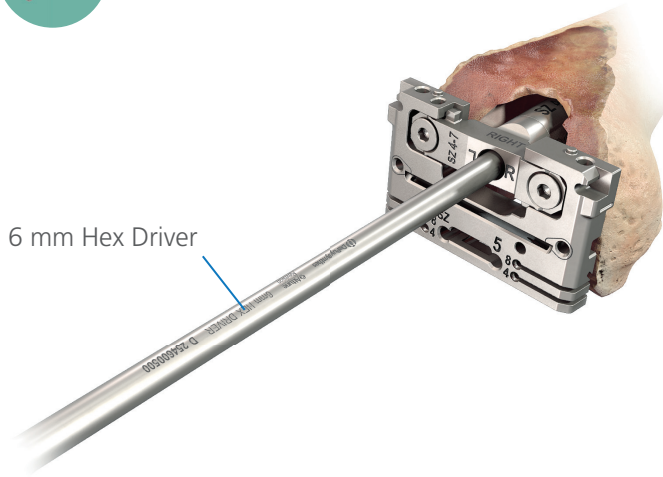

6 mm Hex Driver

Reassemble the Conventional Cut Guide Assembly to the new Broach retained in the bone leaving the Central Bolt slightly loose.

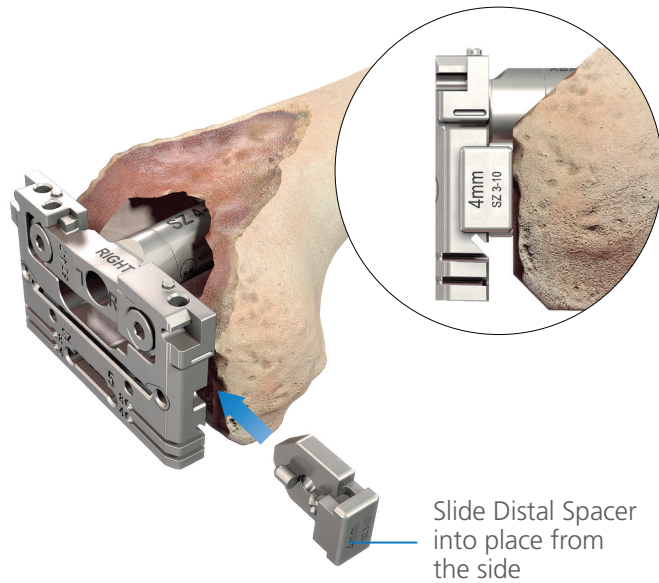

Slide Distal Spacer into place from the side

Add the Distal Spacers that correspond to the Broach Stop Shim that was utilized.

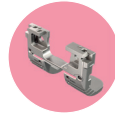

FE Guide



Femoral Sleeve and Stem

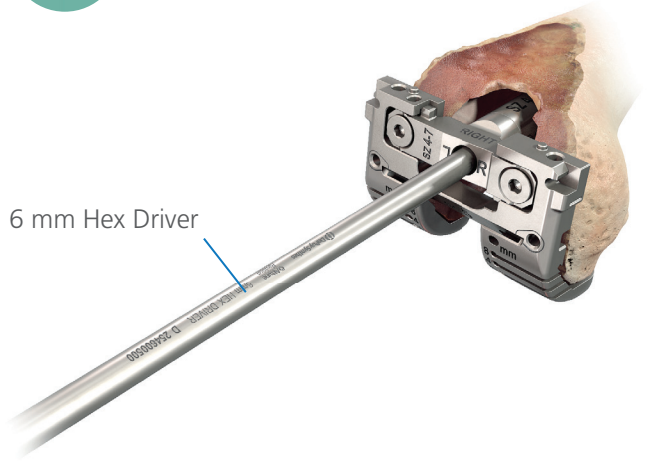

6 mm Hex Driver

Reassemble the FE Guide Assembly to the new Broach retained in the bone leaving the Central Bolt slightly loose.

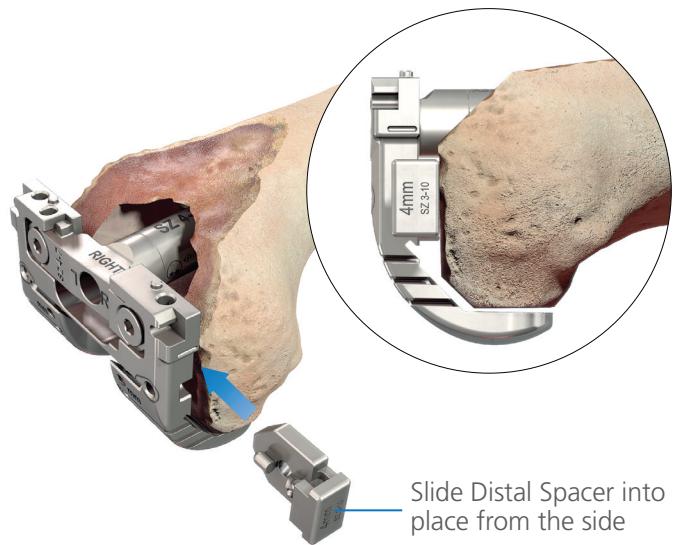

Slide Distal Spacer into place from the side

Add the Distal Spacers that correspond to the Broach Stop Shim that was utilized.

Femoral Preparation

Establishing the Flexion Gap and Setting Rotation



Conventional Cut Guide



Femoral Sleeve and Stem

Torque Driver Assembly

"click"

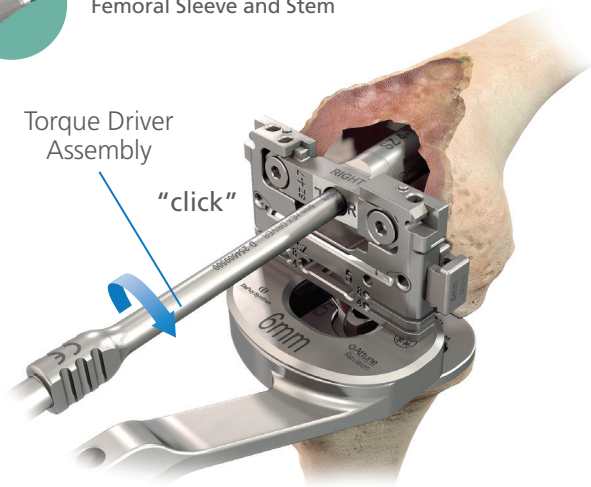

Return the knee to flexion, re-introduce the Revision Spacer Block Assembly (or Femoral Positioner Assembly), set the rotation of the Conventional Cut Guide and lock the Central Bolt.

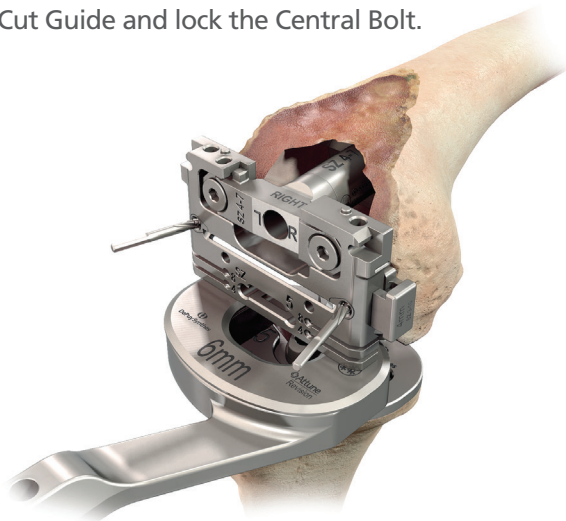

Pin the Conventional Cut Guide and proceed with femoral preparation.

For completing femoral resections with a Sleeve, proceed to **page 109**.

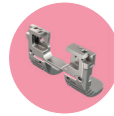

FE Guide



Femoral Sleeve and Stem

Torque Driver Assembly

"click"

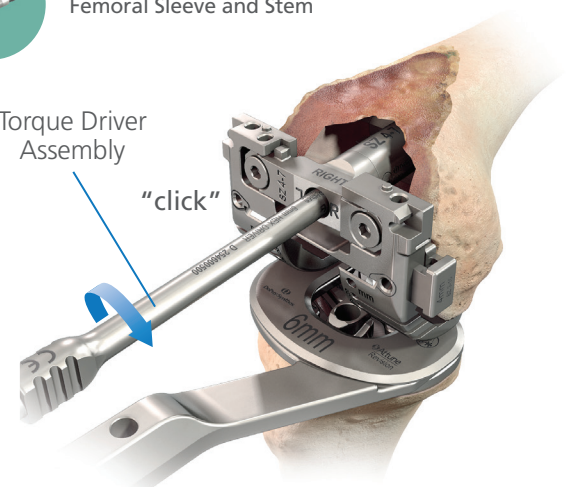

Return the knee to flexion, re-introduce the Revision Spacer Block Assembly, set the rotation of the FE Guide and lock the Central Bolt.

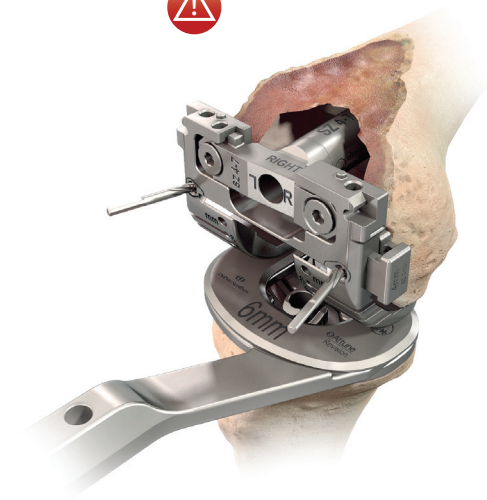

Pin the FE Guide and proceed with femoral preparation.

For completing femoral resections with a Sleeve, proceed to **page 109**.



CAUTION

If posterior condylar bone is present, it may affect the ability to rotate the FE Guide.

Femoral Preparation

Anterior and Posterior Resections

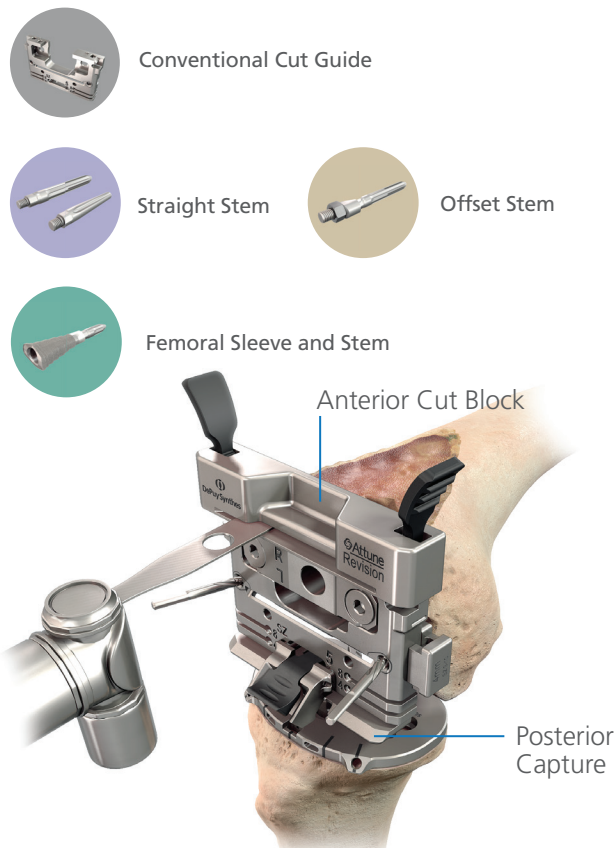

Straight Stem Assembly Depicted

Remove the Spacer Block or Femoral Positioner prior to performing femoral resections.

Attach the Anterior Cut Block and perform the anterior resection.

Assemble the corresponding sized Posterior Capture to the Cut Guide and perform the posterior resection. If Posterior Augments are required, the Posterior Augment resection may be made through the Augment slots in the Cut Guide.

For completing femoral resections with a Straight Stem or Sleeve, proceed to **page 111**.

For completing femoral resections with an Offset Stem, proceed to **page 112**.

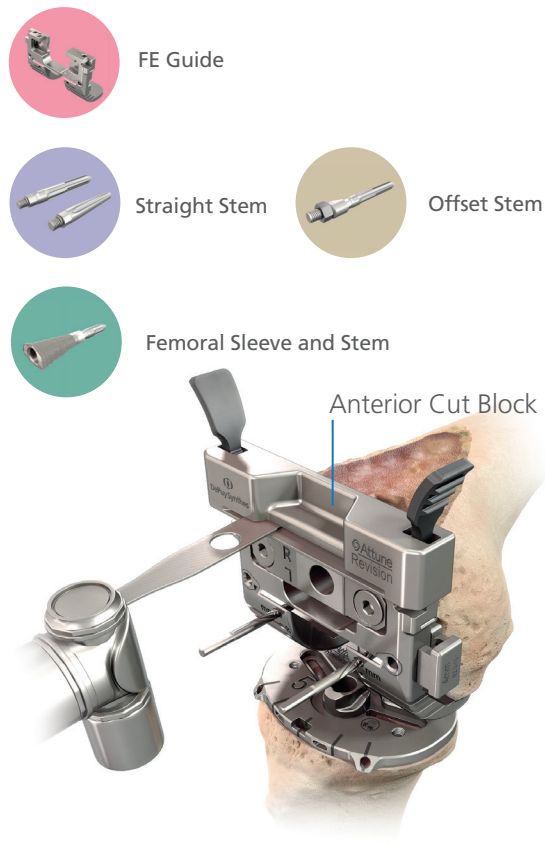

Straight Stem Assembly Depicted

Remove the Spacer Block prior to performing femoral resections.

Attach the Anterior Cut Block and perform the anterior resection.

Perform the posterior resection. If Posterior Augments are required, the Posterior Augment resection may be made through the Augment slots in the FE Cut Guide.

Proceed to **page 110**.

i INFORMATION

When using an Offset Stem in smaller sizes of femur, certain orientations of the Femoral Offset Guide may inhibit the ability to complete the anterior resection. Therefore, prior to completing the anterior resection, check for Saw Blade impingement on the Femoral Offset Guide. If necessary, prior to initiating the anterior cut, the Conventional Cut Guide or FE Guide can be pinned and the Femoral Offset Guide removed using the System Handle.

Femoral Preparation

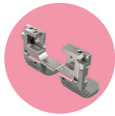

FE Guide



Straight Stem



Offset Stem



Femoral Sleeve and Stem

The Posterior Spacer may be inserted in to the posterior slots of the FE Guide to aid in stabilizing the Guide during subsequent resections or bone preparation.

For completing femoral resections with a Straight Stem or Sleeve, proceed to **page 111**.

For completing femoral resections with an Offset Stem, proceed to **page 112**.

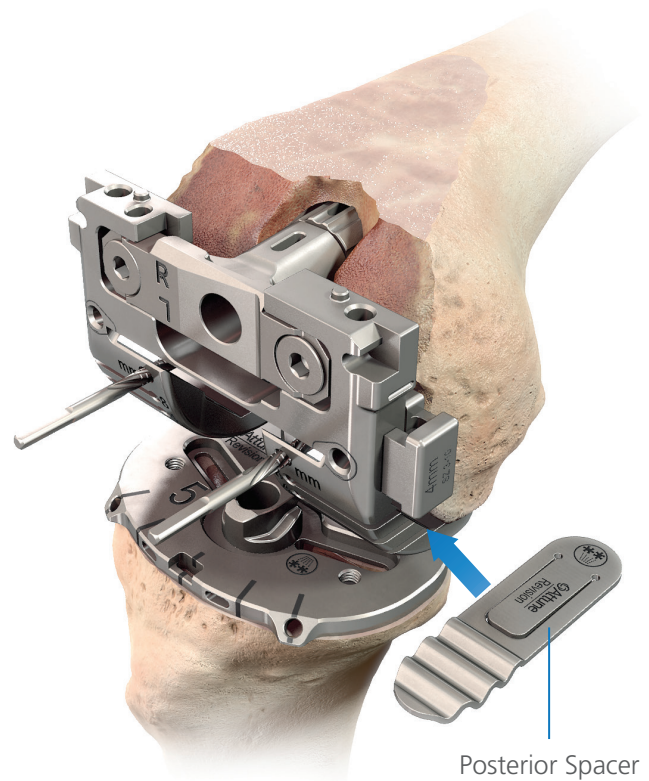

Femoral Preparation

Chamfer and Distal Augment Resections



Conventional Cut Guide



Straight Stem



Femoral Sleeve and Stem

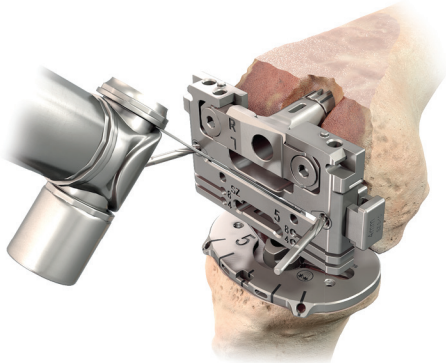

Perform the posterior chamfer resection.

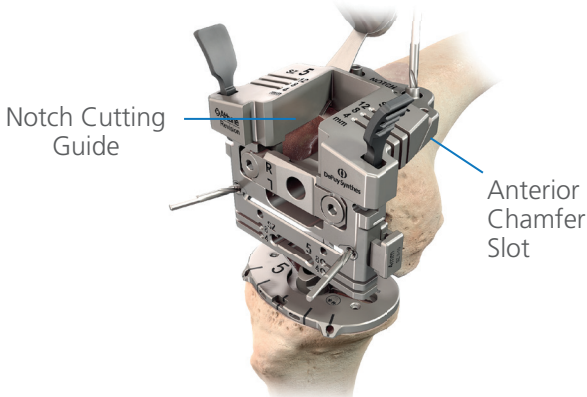

Attach the Notch Cutting Guide and perform the anterior chamfer and any necessary Distal Augment resections. If Distal Augment resections were made, Distal Spacers may be inserted in the Conventional Cut Guide to stabilize the Guide. 

For Box preparation with a Straight Stem, proceed to **page 117**.

For completing the Box resection with a Sleeve, proceed to **page 119**.

CAUTION

If Pins were added to the distal surface of the Conventional Cut Block, they will need to be removed from the deficient side prior to performing any Augment resections.

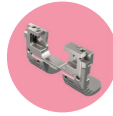

FE Guide



Straight Stem



Femoral Sleeve and Stem

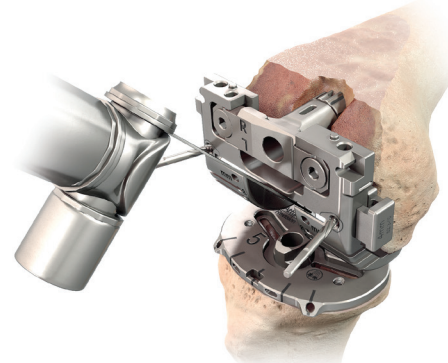

Perform the posterior chamfer resection.

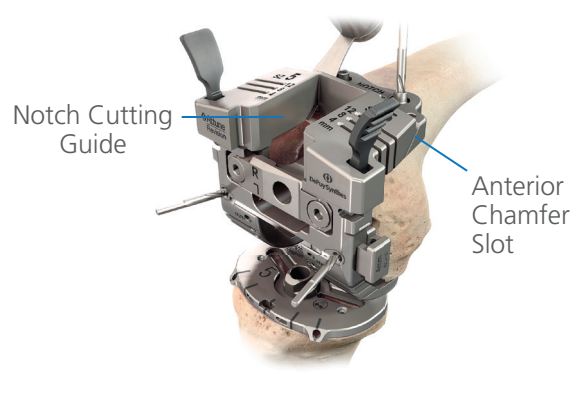

Attach the Notch Cutting Guide and perform the anterior chamfer and any necessary Distal Augment resections. If Distal Augment resections were made, Distal Spacers may be inserted in the FE Guide to stabilize the Guide. 

For Box preparation with a Straight Stem, proceed to **page 117**.

For completing the Box resection with a Sleeve, proceed to **page 119**.

CAUTION

If Pins were added to the distal surface of the FE Guide, they will need to be removed from the deficient side prior to performing any Augment resections.

Femoral Preparation

Anterior and Posterior Resections



Conventional Cut Guide



Offset Stem

Torque Limiting
Screwdriver Assembly

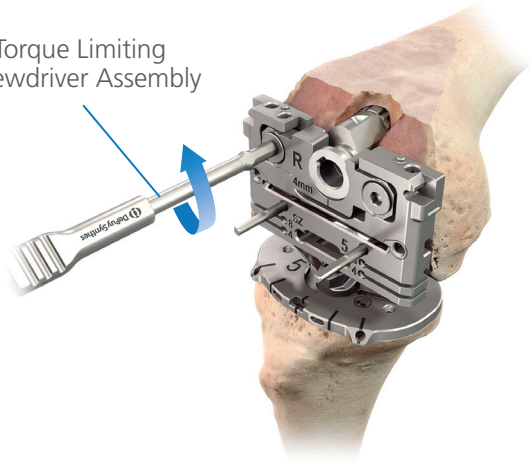

To perform the anterior and posterior chamfer, box resection and any necessary Distal Augment resections, disconnect the Femoral Offset Guide from the Conventional Cut Guide.

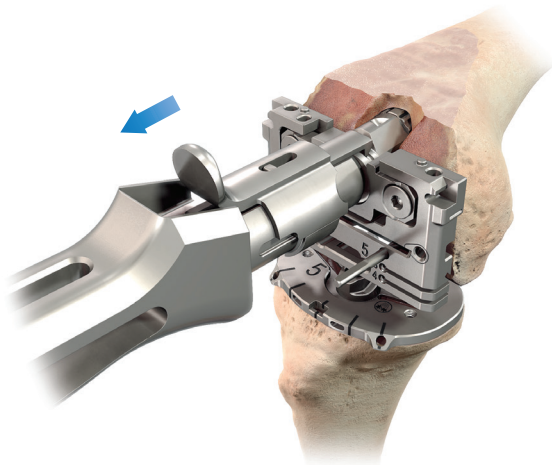

Connect the Revision System Handle to the Femoral Offset Guide Assembly and translate the Femoral Offset Guide distal to the Conventional Cut Guide.

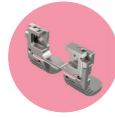

FE Guide



Offset Stem

Torque Limiting
Screwdriver Assembly

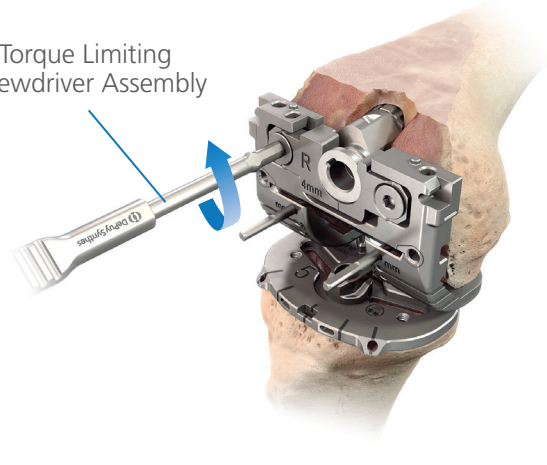

To perform the anterior and posterior chamfer, box resection and any necessary Distal Augment resections, disconnect the Femoral Offset Guide from the FE Guide.

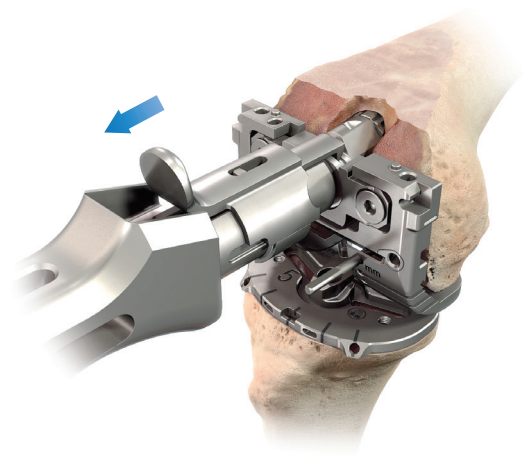

Connect the Revision System Handle to the Femoral Offset Guide Assembly and translate the Femoral Offset Guide distal to the FE Guide.

Femoral Preparation

Anterior and Posterior Resections



Conventional Cut Guide



Offset Stem

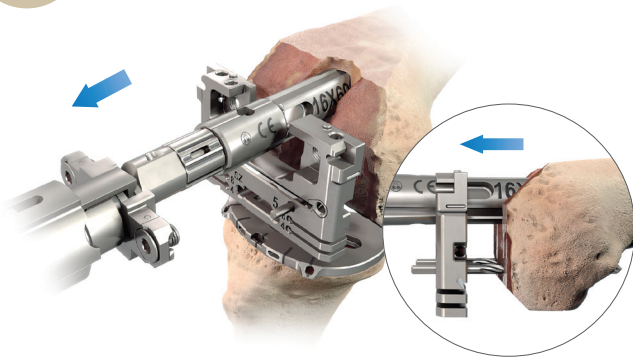

While translating the Femoral Offset Guide out of the prepared femur, separately translate the Conventional Cut Guide along the Parallel Pins.

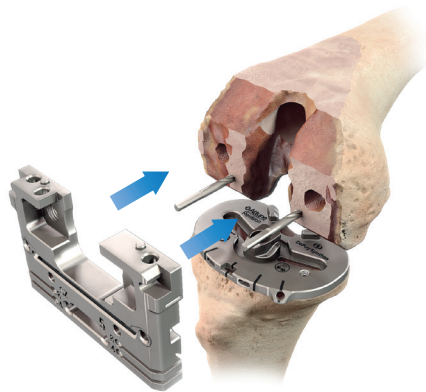

Once the Femoral Offset Guide, Stem Stabilizer, and Stem Trial have cleared the prepared femur, re-introduce the Conventional Cut Guide onto the distal femur via the Parallel Pins.

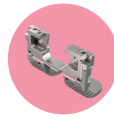

FE Guide



Offset Stem

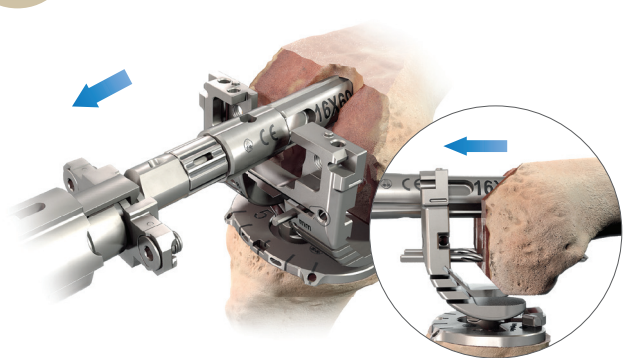

While translating the Femoral Offset Guide out of the prepared femur, separately translate the FE Guide along the Parallel Pins.

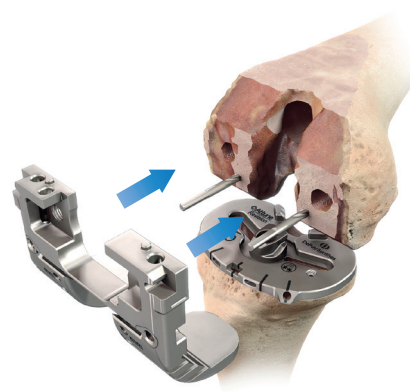

Once the Femoral Offset Guide, Stem Stabilizer, and Stem Trial have cleared the prepared femur, re-introduce the FE Guide onto the distal femur via the Parallel Pins.



INFORMATION

In cases of significant distal bone loss, one could proceed to the Cut Through Trial workflow at this time with the Femoral Offset position noted. The Box resection and Boss Ream may alternatively be made through the Cut Through Trial.

For smaller magnitude offsets and/or smaller diameter Stem Stabilizers and Stem Trials, the Femoral Offset Guide may be extracted from the femur without simultaneously having to remove the Conventional Cut Guide or FE Guide in these situations, the Angled Pin Holes can be used in preference to the Parallel Pin Holes for initial fixation.

Femoral Preparation

Chamfer and Distal Augment Resections



Conventional Cut Guide



Offset Stem

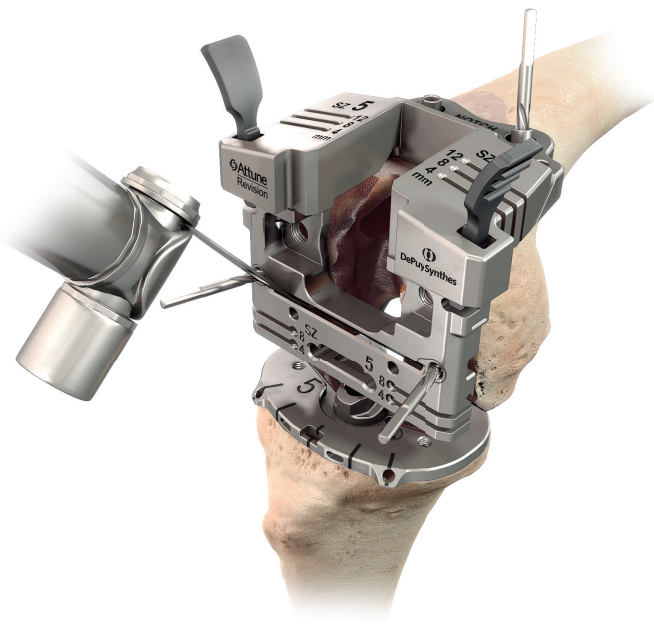

Pin through the Convergent Pin Holes, and remove all Parallel Pins. Complete the posterior chamfer resection.

Attach the Notch Cutting Guide and perform the anterior chamfer and any necessary Distal Augment resections. If Distal Augment resections were made, Distal Spacers may be inserted in the Conventional Cut Guide to stabilize the Guide.

For Boss and Offset Adaptor preparation with an Offset Stem, proceed to **page 115**.

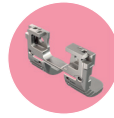

FE Guide



Offset Stem

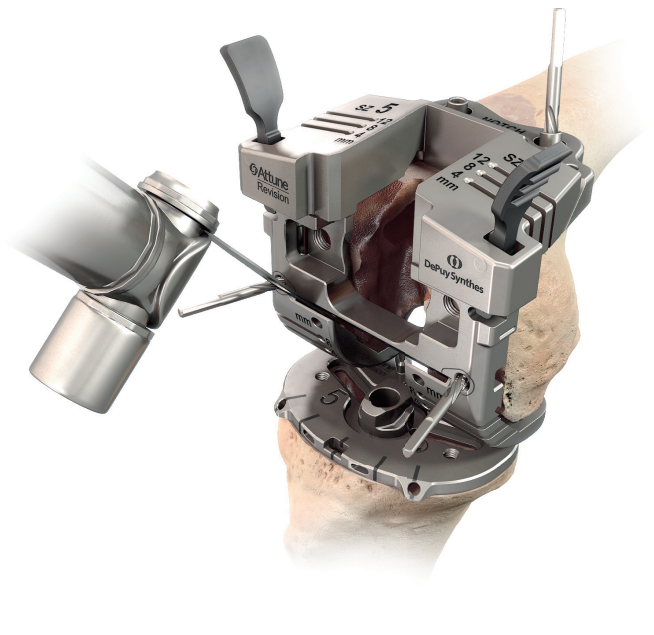

Pin through the Convergent Pin Holes, and remove all Parallel Pins. Complete the posterior chamfer resection.

Attach the Notch Cutting Guide and perform the anterior chamfer and any necessary Distal Augment resections. If Distal Augment resections were made, Distal Spacers may be inserted in the FE Guide to stabilize the Guide.

For Boss and Offset Adaptor preparation with an Offset Stem, proceed to **page 115**.

Femoral Preparation

Boss and Offset Adaptor Reaming



Conventional Cut Guide



Offset Stem

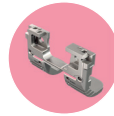

FE Guide

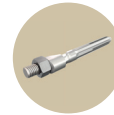

Offset Stem

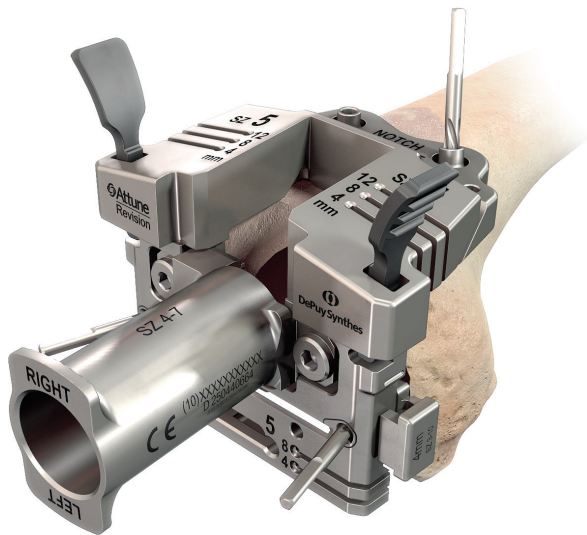

Assemble the appropriately sized Conventional Cut Guide Reamer Guide with the correct orientation facing upwards, "Left or Right", to the Conventional Cut Guide.

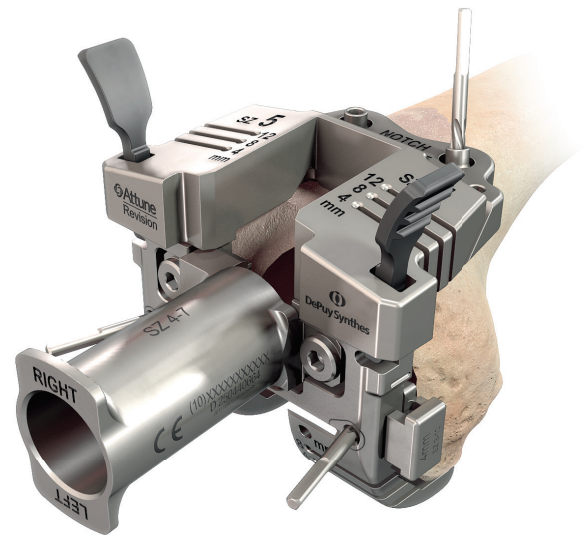

Assemble the appropriately sized Conventional Cut Guide Reamer Guide with the correct orientation facing upwards, "Left or Right", to the FE Guide.

Femoral Preparation

Boss and Offset Adaptor Reaming



Conventional Cut Guide



Offset Stem



Assemble the Modular Stop to the Offset Drill and prepare the femoral canal.

Seat the Drill to the Stop.

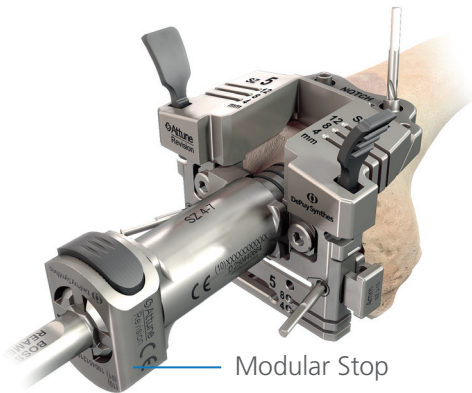

Modular Stop

With the Femoral Offset Adaptor prepared, remove the Offset Drill and Conventional Cut Guide Reamer Guide from the Cutting Guide Assembly.

For Box Resection, proceed to **page 117**.

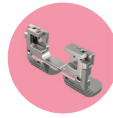

FE Guide



Offset Stem



Assemble the Modular Stop to the Offset Drill and prepare the femoral canal.

Seat the Drill to the Stop.

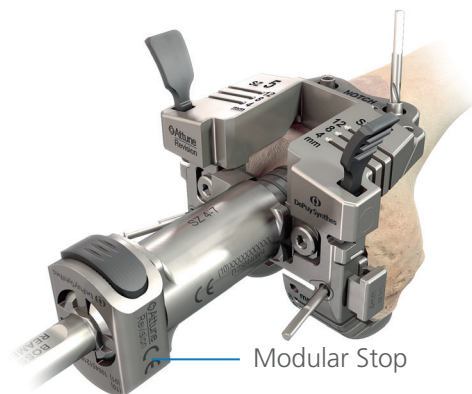

Modular Stop

With the Femoral Offset Adaptor prepared, remove the Offset Drill and Conventional Cut Guide Reamer Guide from the FE Guide Assembly.

For Box Resection, proceed to **page 117**.



INFORMATION

The Notch Cutting Guide size must match the Conventional Cut Guide or the FE Guide size.

Additional fixation may be achieved utilizing the Omni-ball Pin Holes in the Notch Cutting Guide which allow for an adjustable Pin direction and position Pins superiorly in the Anterior Femur.

Femoral Preparation

Box Resection



Conventional Cut Guide



Straight Stem



Offset Stem

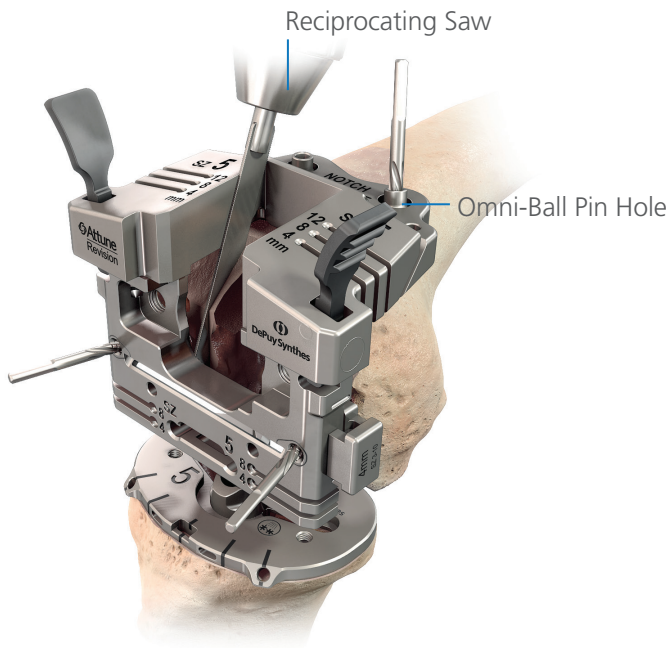

With the Notch Cutting Guide attached, complete resection of the two sides and top of the box with a Reciprocating Saw Blade.

Optionally, the Notch Guide may be pinned through the Parallel Pin Holes to allow for removal of the Conventional Cut Guide to complete the Box resection, if desired.

With the femoral preparation complete, remove the Conventional Cut Guide Assembly.

For Boss preparation with a Straight Stem, proceed to **page 118**.

For Femoral Trial Assembly with Offset Stem with a Cut Through Trial proceed to **page 121**.

For Femoral Trial Assembly with Offset Stem with a Solid Femoral Trial proceed to **page 122**.

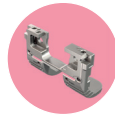

FE Guide



Straight Stem



Offset Stem

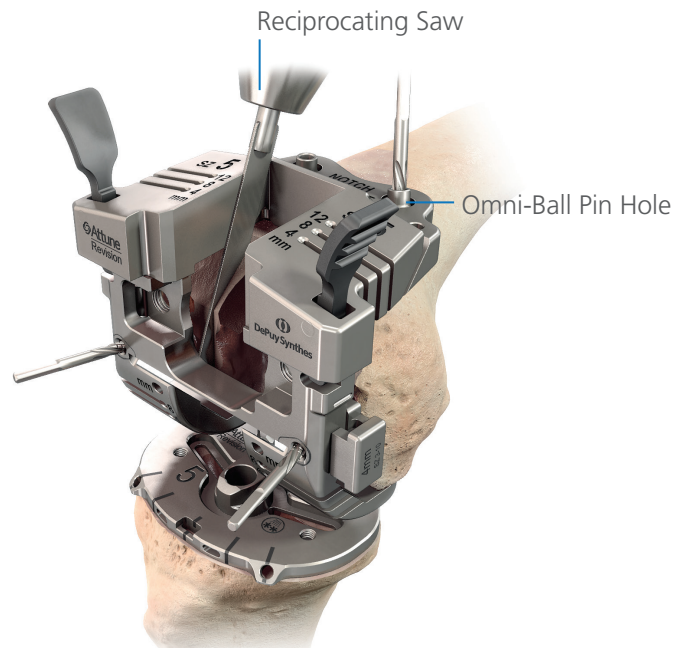

With the Notch Cutting Guide attached, complete resection of the two sides and top of the box with a Reciprocating Saw Blade.

Optionally, the Notch Guide may be pinned through the Parallel Pin Holes to allow for removal of the FE Guide to complete the Box resection, if desired.

With the femoral preparation complete, remove the FE Guide Assembly.

For Boss preparation with a Straight Stem, proceed to **page 118**.

For Femoral Trial Assembly with Offset Stem with a Cut Through Trial proceed to **page 121**.

For Femoral Trial Assembly with Offset Stem with a Solid Femoral Trial proceed to **page 122**.

Femoral Preparation

Boss Reaming



Conventional Cut Guide

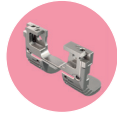

FE Guide



Straight Stem

Remove all Pins and the Conventional Cut Guide or FE Guide Assembly from the bone.

Assemble the appropriate Stem Trial to the Femoral Boss Reamer.

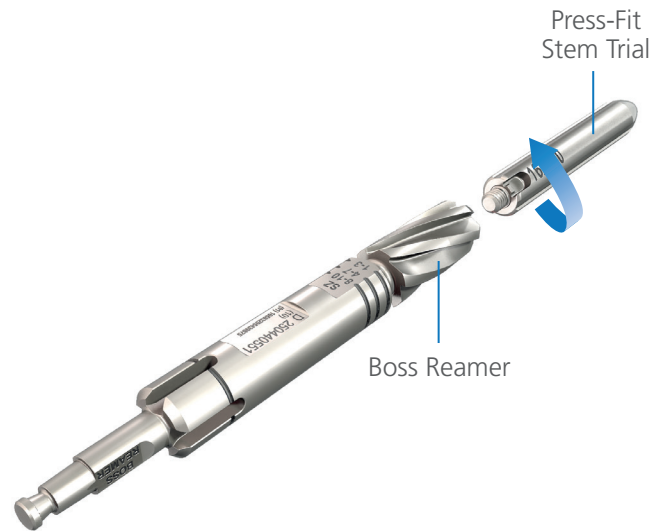

Utilize the Stem Trial in the reamed femoral canal to pilot the Boss Reamer until the appropriate femoral size marking in the grouping of markings on the Boss Reamer is aligned with the distal surface of the femur. If Distal Augments were prepared, the size grouping line should be proud of the respective distal femur surface by the thickness of the Distal Augment(s).

The size groupings on the Boss Reamer represent the distal bone surface and not the anticipated joint line.



For Femoral Trial Assembly with Offset Stem with a Cut Through Trial proceed to **page 121**.

For Femoral Trial Assembly with Offset Stem with a Solid Femoral Trial proceed to **page 122**.



CAUTION

Do not reverse ream.

Femoral Preparation

Box Resection



Conventional Cut Guide



Femoral Sleeve and Stem

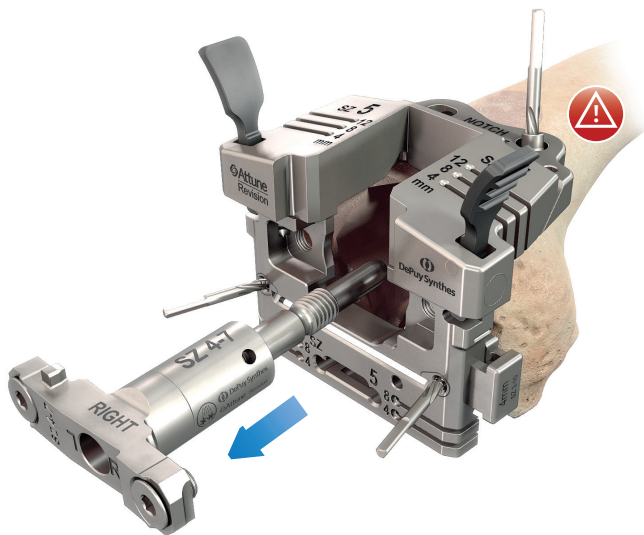

To allow for complete resection of the box, disengage and remove the Broach Adaptor from the Conventional Cut Guide and Broach by releasing the two Hexes in the Cutting Block and the one Hex in the Broach Adaptor. An additional Pin may be added to the Notch Cutting Guide to aid in fixation.

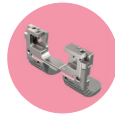

FE Guide



Femoral Sleeve and Stem

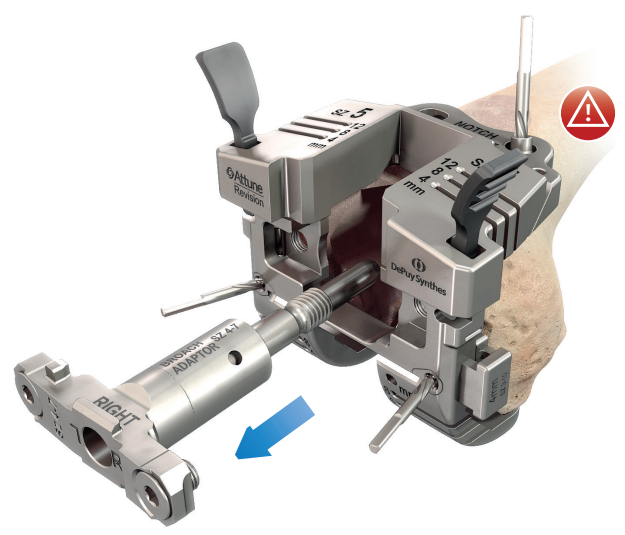

To allow for complete resection of the box, disengage and remove the Broach Adaptor from the FE Guide and Broach by releasing the two Hexes in the Cutting Block and the one Hex in the Broach Adaptor. An additional Pin may be added to the Notch Cutting Guide to aid in fixation.



CAUTION

Care should be taken when placing a Pin through the Omni-Ball Hole in the Notch Cutting Guide which allow for an adjustable Pin direction to angle the Pin towards the periphery of the bone to avoid pinning into the Femoral Broach.

Femoral Preparation

Box Resection



Conventional Cut Guide



Femoral Sleeve and Stem

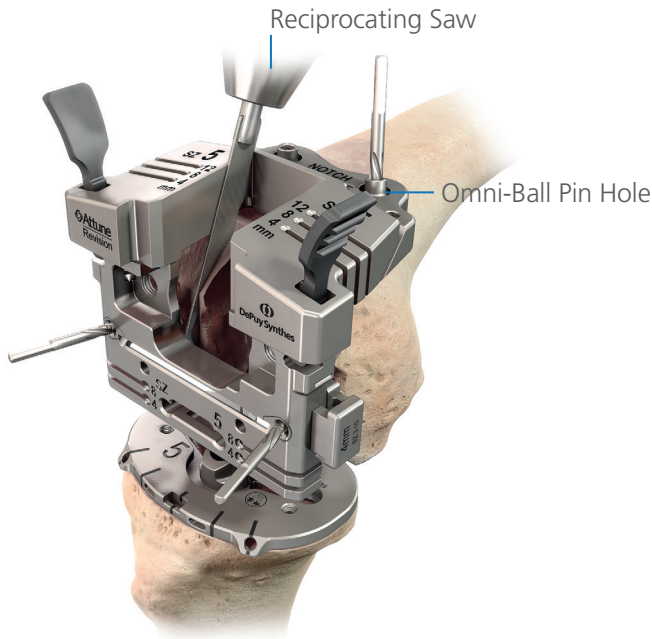

With the Notch Cutting Guide attached, complete resection of the two sides and top of the box with a Reciprocating Saw Blade.

Optionally, the Notch Guide may be pinned through the Parallel Pin Holes to allow for removal of the Conventional Cut Guide to complete the Box resection, if desired.

With the femoral preparation complete, remove the Conventional Cut Guide Assembly leaving the Broach in place.

For Femoral Trial assembly with a Broach, go to **page 123**.



FE Guide



Femoral Sleeve and Stem

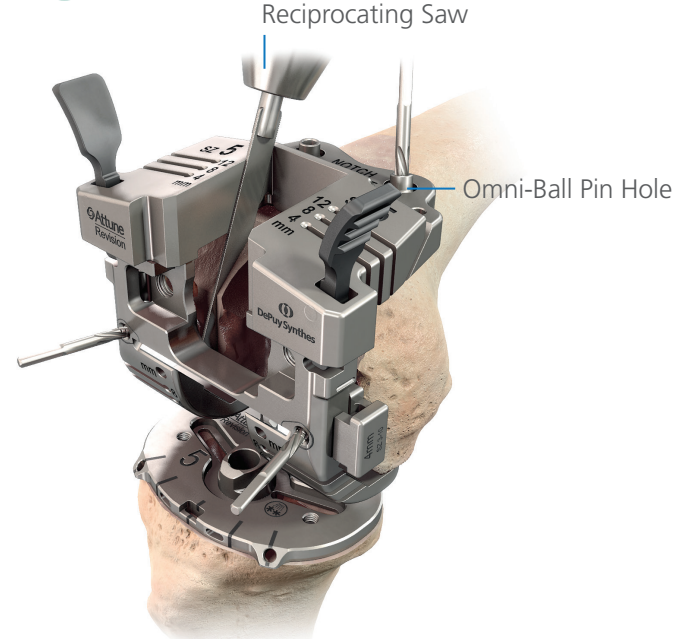

With the Notch Cutting Guide attached, complete resection of the two sides and top of the box with a Reciprocating Saw Blade.

Optionally, the Notch Guide may be pinned through the Parallel Pin Holes to allow for removal of the FE Guide to complete the Box resection, if desired.

With the femoral preparation complete, remove the FE Guide Assembly leaving the Broach in place.

For Femoral Trial assembly with a Broach, go to **page 123**.



INFORMATION

The Notch Cutting Guide size must match the Conventional Cut Guide or FE Guide size.

Additional fixation may be achieved utilizing the Omni-Ball Pin Holes in the Notch Cutting Guide which allows for an adjustable Pin direction and position Pins superiorly in the Anterior Femur.

Femoral Preparation

Seating the Femoral Trial



Cut Through Trial



Straight Stem



Offset Stem



Assemble the Femoral Trial with the Box Trial, Boss Trial or appropriate Offset Adaptor Trial, Stem Trial Bolt, Stem Trial, as described on **pages 55 and 57**, and any appropriate Augment Trials as described on **page 60**.



If offset is being used, position the Femoral Offset Adaptor Trial to the offset orientation previously noted from the Femoral Offset Guide, and tighten the Stem Trial Bolt. Utilize the marking on the posterior aspect of the Box Trial and corresponding number on the Offset Boss Adaptor Trial as described on **page 57**.

Introduce the Femoral Trial Assembly to the prepared femur. Utilize the ATTUNE System Impactor to seat the Femoral Trial.

Introduce the Revision Tibial Insert Trial and proceed to **Setting Tibial Base Rotation on page 151**.



CAUTION

If the box resection is not complete, the connecting components may not seat.



INFORMATION

If the Cut Through Trial is unstable, pinning anteriorly is an option.



CAUTION

The ATTUNE Revision Femoral Augment Trials contain magnets. These devices should be kept at a safe distance from a patient's active implantable medical device(s) (i.e. pacemaker) in order to avoid adversely affecting the device. The Femoral Augment Trials should be kept at an appropriate location when not in use in the surgical site.

Femoral Preparation

Seating the Femoral Trial



Solid Femoral Trial



Straight Stem



Offset Stem



Assemble the Femoral Trial, Boss Trial or appropriate Offset Adaptor Trial, Stem Trial Bolt, Stem Trial as described on **pages 56 and 57** any appropriate Augment Trials as described in **page 60**. 

If offset is being used, position the Femoral Offset Adaptor Trial to the offset orientation previously noted from the Femoral Offset Guide, and tighten the Stem Trial Bolt. Utilize the marking on the posterior aspect of the Femoral Box and corresponding number of the Offset Boss Adaptor Trial as described on **page 57**.

Introduce the Femoral Trial Assembly to the prepared femur. Utilize the ATTUNE System Impactor to seat the Femoral Trial.

Introduce the Revision Tibial Insert Trial and proceed to **Setting Tibial Base Rotation on page 151**.



CAUTION

If the box resection is not complete, the connecting components may not seat.



CAUTION

The ATTUNE Revision Femoral Augment Trials contain magnets. These devices should be kept at a safe distance from a patient's active implantable medical device(s) (i.e. pacemaker) in order to avoid adversely affecting the device. The Femoral Augment Trials should be kept at an appropriate location when not in use in the surgical site.

Femoral Preparation

Seating the Femoral Trial



Cut Through Trial



Femoral Sleeve and Stem

Assemble the Cut Through Femoral Trial with the Box Trial and any appropriate Augment Trials as described on page 60. 

Introduce the Femoral Trial Assembly to the prepared femur and introduce the Femoral Broach Trial Bolt through the hole in the Box Trial and into the Femoral Broach. Tighten with the Torque Driver with 6 mm Hex Driver.

Introduce the Revision Tibial Insert Trial and proceed to **Setting Tibial Base Rotation** on page 151.

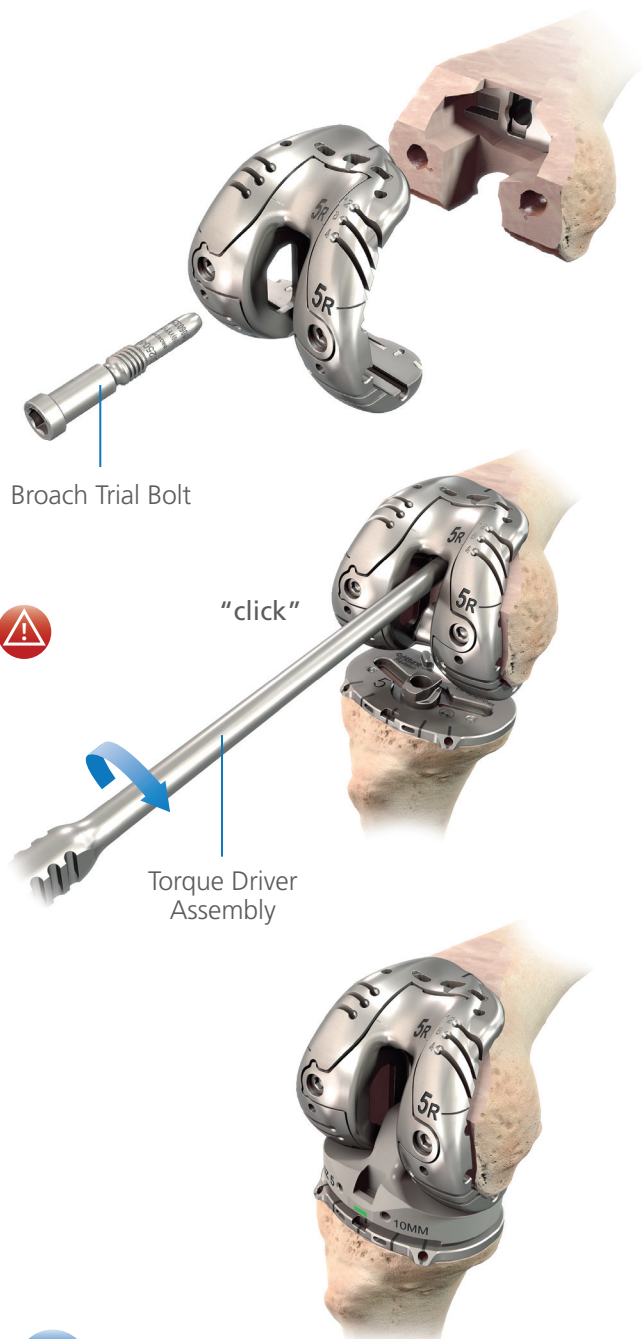

Broach Trial Bolt

"click"

Torque Driver Assembly

CAUTION

The ATTUNE Revision Femoral Augment Trials contain magnets. These devices should be kept at a safe distance from a patient's active implantable medical device(s) (i.e. pacemaker) in order to avoid adversely affecting the device. The Femoral Augment Trials should be kept at an appropriate location when not in use in the surgical site.

CAUTION

If impaction of the Femoral Trial is necessary, the ATTUNE System Impactor is recommended.

INFORMATION

If the Femoral Trial Assembly and Broach Trial Bolt do not engage in the Broach, slightly extract the Broach with the Broach Handle, attach the Femoral Trial Assembly to the Broach via the Broach Bolt leaving it slightly loose to allow the instruments to locate within the prepared cavity, and advance the trial construct until seated to the prepared depth.

Femoral Preparation

Seating the Femoral Trial



Solid Femoral Trial



Femoral Sleeve and Stem

Assemble the Femoral Trial with any appropriate Augment Trials as described on [page 60](#).

Introduce the Femoral Trial Assembly to the prepared femur and introduce the Femoral Broach Trial Bolt through the hole in the Femoral Box and into the Femoral Broach. Tighten with the Torque Driver with 6 mm Hex Driver.

Introduce the Revision Tibial Insert Trial and proceed to [Setting Tibial Base Rotation on page 151](#).

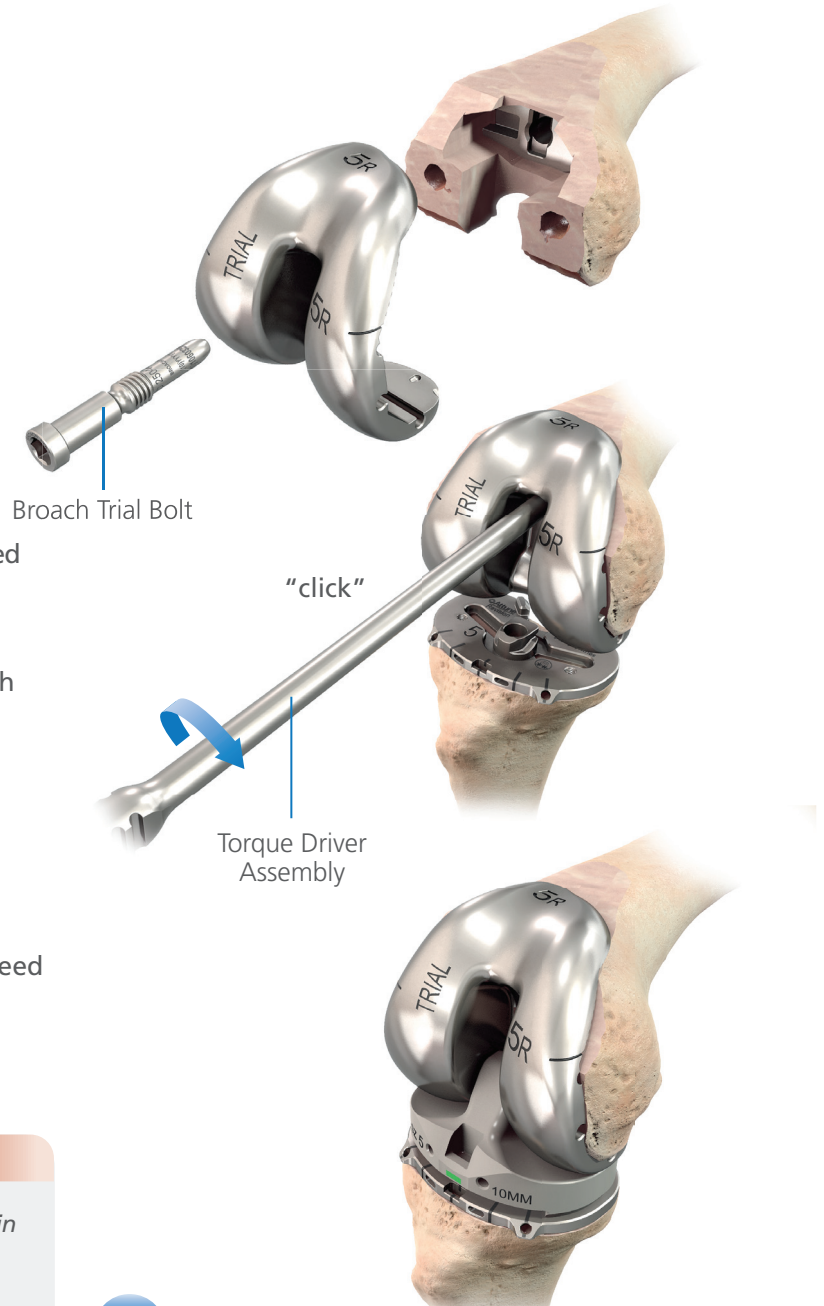

CAUTION

The ATTUNE Revision Femoral Augment Trials contain magnets. These devices should be kept at a safe distance from a patient's active implantable medical device(s) (i.e. pacemaker) in order to avoid adversely affecting the device. The Femoral Augment Trials should be kept at an appropriate location when not in use in the surgical site.



CAUTION

If impaction of the Femoral Trial is necessary, the ATTUNE System Impactor is recommended.



INFORMATION

If the Femoral Trial Assembly and Broach Trial Bolt do not engage in the Broach, slightly extract the Broach with the Broach Handle, attach the Femoral Trial Assembly to the Broach via the Broach Bolt leaving it slightly loose to allow the instruments to locate within the prepared cavity, and advance the trial construct until seated to the prepared depth.

Femoral Preparation

Setting Femoral Position



Cut Through Trial

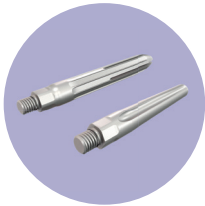

Straight Stem
Proceed to **page 126**

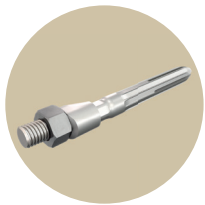

Offset Stem
Proceed to **page 129**



Femoral Sleeve and Stem
Proceed to **page 140**



INFORMATION

Prior to proceeding to the Femoral Sleeve and Stem workflow the Straight Stem workflow must be completed.

Femoral Preparation

Cut Through Trial



Cut Through Trial



Straight Stem

If there is substantial bone loss, once the femoral canal has been prepared and if the femoral size has been determined to be a size 3 or larger following the methods described from **pages 75 to 79** then it is possible to use the Cut Through Trial workflow. Ream for the Femoral Boss by assembling the appropriate Stem Trial to the Femoral Boss Reamer.

Utilize the Stem Trial in the reamed femoral canal to pilot the Boss Reamer until the appropriate femoral size marking in the grouping of markings on the Boss Reamer is aligned with the distal surface of the femur. If Distal Augments were prepared, the size grouping line should be proud of the respective distal femur surface by the thickness of the Distal Augment(s).

The size groupings on the Boss Reamer represent the distal bone surface and not the anticipated joint line.

i INFORMATION

*The Cut Through Trials are available in Sizes 3 - 10.
The Conventional Cut Guide must be utilized to prepare femurs of sizes 1 or 2.*

i INFORMATION

If the prior Femoral Component was malrotated, the revised femur bone may influence the rotation of the Cut Through Trial if not mindful of this when assessing femoral position.

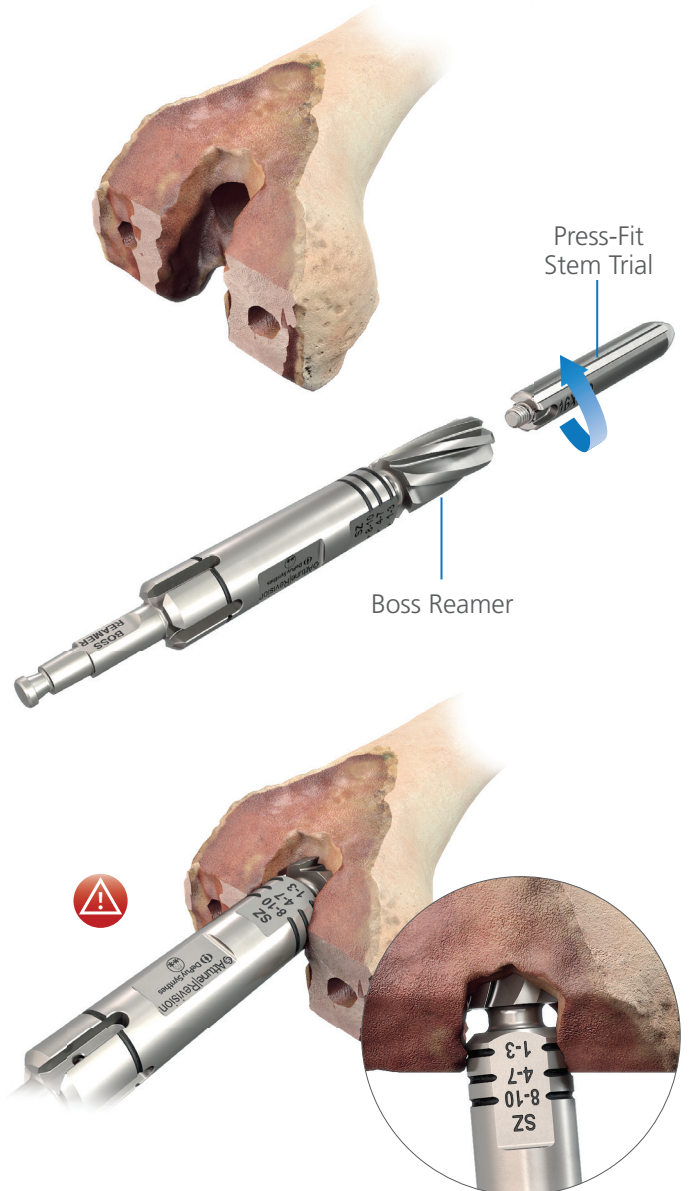

! CAUTION

Do not reverse ream.

Femoral Preparation

Cut Through Trial Assembly



Cut Through Trial



Straight Stem

Assemble the Cut Through Trial to the corresponding IM Connector, Stem Trial Bolt, Boss Trial, and appropriate Stem Trial.

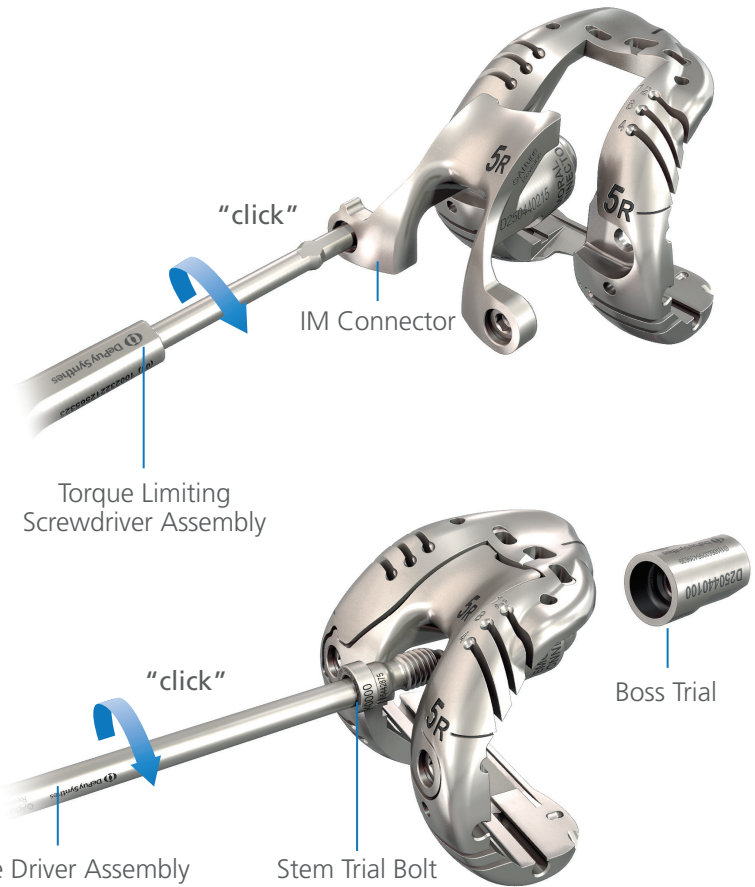

INFORMATION

To aid in stabilizing the femoral rotation, Posterior Augment Trials may be added to the Cut Through Trials.



INFORMATION

The Cut Through Trial IM Connector is size and side specific.

Femoral Preparation

Cut Through Trial Placement



Cut Through Trial



Straight Stem



Introduce the Femoral Trial Assembly to the prepared femur. Allow the Femoral Trial Assembly to sit slightly proud of the femoral bone to allow for joint line assessment.



Trial proud to allow for joint line assessment

Optionally, the Distalizing Gauge may be utilized to provide an additional reference to the epicondyles.

For Gap Balancing, Setting Rotation, and completing femoral resections with a Straight Stem, proceed to [page 132](#).



Distalizing Gauge



INFORMATION

It is optional to allow the Femoral Trial to sit proud. This option allows for final assessment of the superior/inferior position to be determined with the aid of an Insert Trial or Spacer Block.



CAUTION

To prevent the potential for femoral bone fracture the IM Connector and Cut Through Trial should only be used in the cases with substantial bone loss. Otherwise go to Revision Femoral with a Straight Stem utilizing the Conventional Cut Guide on [page 81](#).

Femoral Preparation

Cut Through Trial Assembly



Cut Through Trial



Offset Stem



Once the femoral canal has been prepared using the Canal Reamers and the femoral size has been determined following the methods described from **pages 75 to 79**, proceed with this workflow only if there is substantial bone loss, enough to allow for the Cut Through Trial assembled with the IM Connector, Offset Boss Adaptor Trial, and appropriate Stem Trial to be introduced to the femoral bone.

Assemble the Cut Through Trial to the corresponding IM Connector by tightening the Hexes.

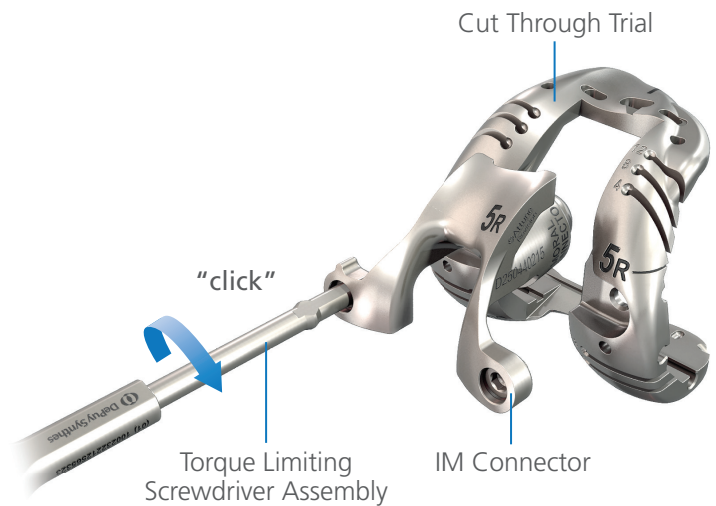

INFORMATION

*The Cut Through Trials are available in Sizes 3 - 10.
The Conventional Cut Guide must be utilized to prepare femurs of sizes 1 or 2.*



CAUTION

*To prevent the potential for femoral bone fracture the IM Connector and Cut Through Trial should only be used in the cases with substantial bone loss. Otherwise go to **Revision Femoral with Offset Stem utilizing the Conventional Cut Guide on page 91.***

Femoral Preparation

Cut Through Trial Assembly



Cut Through Trial



Offset Stem

Loosely assemble the Stem Trial Bolt to the Femoral Offset Adaptor Trial through the IM Connector using the Torque Driver Assembly.

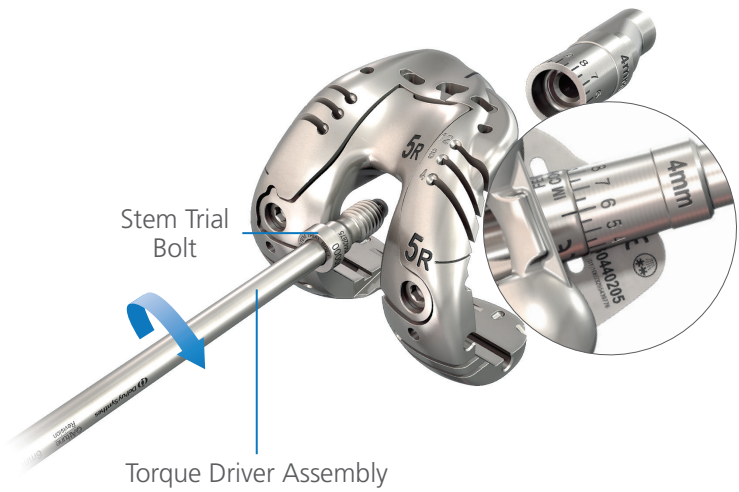

Orient the Femoral Offset Adaptor Trial to the estimated offset orientation to achieve desired femoral position and tighten the Stem Trial Bolt.



Thread the Stem Trial on to the Femoral Offset Adaptor Trial.



Femoral Preparation

Cut Through Trial Placement



Cut Through Trial



Offset Stem

Introduce the Femoral Trial Assembly into the femur.



Allow the Femoral Trial Assembly to sit slightly proud of the femoral bone to allow for joint line assessment.



Trial proud to allow for joint line assessment

Optionally, the Distalizing Gauge may be utilized to provide an additional reference to the epicondyles.



Distalizing Gauge

Femoral Preparation

Gap Balancing and Setting Rotation



Cut Through Trial



Straight Stem



Offset Stem



INFORMATION

If preparing for an Offset Stem, fine tune the Cut Through Trial rotation, then tighten the Femoral Offset Adaptor Trial to the IM Connector (or Box Trial) with the Stem Trial Bolt and assemble to the bone. This can be loosened, removed, rotationally adjusted, and re-tightened during

gap balancing, as necessary. If an acceptable offset position cannot be achieved, replace the Femoral Offset Adaptor Trial with one of another magnitude (2 mm, 4 mm or 6 mm) and reposition the Cut Through Trial.

The ATTUNE Revision Knee System provides two instrument options to balance the flexion gap with the Cut Through Trial: ATTUNE Primary INTUITION PS Tibial Insert Trials, and ATTUNE Revision Spacer Block and Shim.

It is recommended to use the ATTUNE Primary INTUITION PS Insert Trials as the ATTUNE Revision Tibial Insert Trial is not compatible with the IM Connector.

- Primary PS Insert Trial

- Revision Spacer Block



INFORMATION

When choosing Tibial Insert Trials with which to balance the flexion gap, it should be noted that the Revision Tibial Inserts are available in 2 mm increments (6 - 26 mm), while

the ATTUNE Primary Tibial Inserts are available in 1 mm increments (5 - 8 mm) and 2 mm increments (10 - 20 mm).

Femoral Preparation

Balance Soft Tissue



Cut Through Trial



Straight Stem



Offset Stem

As the knee comes out to full extension, if the tension in the medial and lateral collateral ligaments is unequal, appropriate soft tissue releases should be performed in a manner to allow the tension to be equal on both the medial and lateral sides of the knee.

Should the selected joint line by the positioning of the Trials differ widely from the joint line anatomical markers, the surgeon has the ability to change the distal/proximal position of the Femoral Component but will have to mirror these changes with appropriate selection of the Tibial Insert and changes to the femoral sizing.

For solutions to address discrepancies between Flexion and Extension, refer to the chart on **page 101**.

Femoral Preparation

Flexion/Extension Balancing



Cut Through Trial



Straight Stem



Offset Stem

Set rotation and balance the flexion space and, when possible, re-establish the joint line.

- Revision Spacer Block and Shim
- PS Insert Trial



Once desired flexion/extension balance is achieved, note the final Insert thickness used.

If the thinnest Revision Tibial Insert Trial/Spacer Block Assembly may not be utilized, the surgeon has two options:

- The Femoral Cut Through Trial can be downsized which allows increase of the flexion space
- Alternatively, the tibial resection may be increased with a further resection of two or more additional millimeters. This maneuver will also increase the extension gap. Further tibial resection may require that tibial preparation be repeated

Femoral Preparation

Flexion/Extension Balancing



Cut Through Trial



Straight Stem



Offset Stem

Once the desired flexion space is achieved, with the Tibial, Femoral, and ATTUNE PS Tibial Insert Trials or Revision Spacer Block and Shim retained in the joint, gently take the knee into extension.

Allow the Femoral Trial to translate proximally in the femoral canal such that when the knee reaches full extension, the extension space will then match the flexion space.

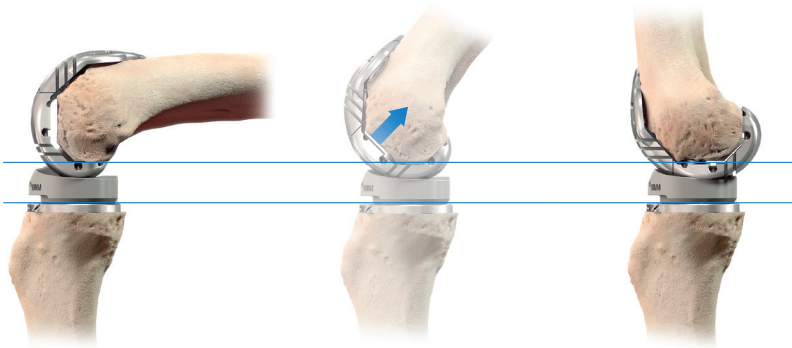

As the leg goes into extension, the Femoral Trial is able to slide up the canal (along the Stem Trial) until it gets to full extension and the extension space then matches the flexion space.

Check that the Femoral Trial is appropriately distalized to maintain tension in the medial and lateral collateral ligaments, and pin the Femoral Trial in position. To allow for trial reduction, the Antero-Medial Pin Hole should be utilized on the Femoral Trial.

The process of assessing flexion and extension gaps may be repeated until desired balance is achieved. Refer to the table on **page 101** to aid in balancing the flexion and extension gaps.



INFORMATION

As an additional reference, if preferred, the interface of the Femoral Trial and Tibial Insert Trial represents the joint line of the implant and should be aligned to the meniscal scar as a re-establishment of the native joint line.



Femoral Preparation

Augment Resections



Cut Through Trial



Straight Stem



Offset Stem

Pin the distal surface of the Cut Through Trial. With the Femoral Trial pinned in place, if Femoral Augments are required, remove the Tibial Insert Trial or Revision Spacer Block Assembly and make the appropriate resections through the Distal and/or Posterior Augment slots ensuring that Pins are not in the way of the resections.

If Distal Augments are required on both the Medial and Lateral sides, pin one side first and resect the opposite side. Assemble the appropriate Augment Trial to the resected side and pin through the augmented distal surface. Remove the opposite distal pin and complete the opposite side resection and insert the corresponding Augment Trial.

Insert the appropriate Femoral Augment Trials by loading from the side of the Femoral Trial. 

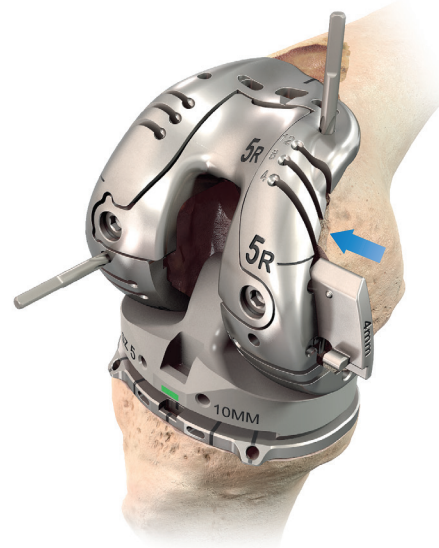

CAUTION

The ATTUNE Revision Femoral Augment Trials contain magnets. These devices should be kept at a safe distance from a patient's active implantable medical device(s) (i.e. pacemaker) in order to avoid adversely affecting the device. The Femoral Augment Trials should be kept at an appropriate location when not in use in the surgical site.

Femoral Preparation

Box Resection



Cut Through Trial



Straight Stem



Offset Stem

With the Femoral Trial pinned in place, remove the Tibial Insert Trial or Revision Spacer Block and Shim. Disconnect the two distal Hexes and remove the IM Assembly utilizing the Angel Wing.

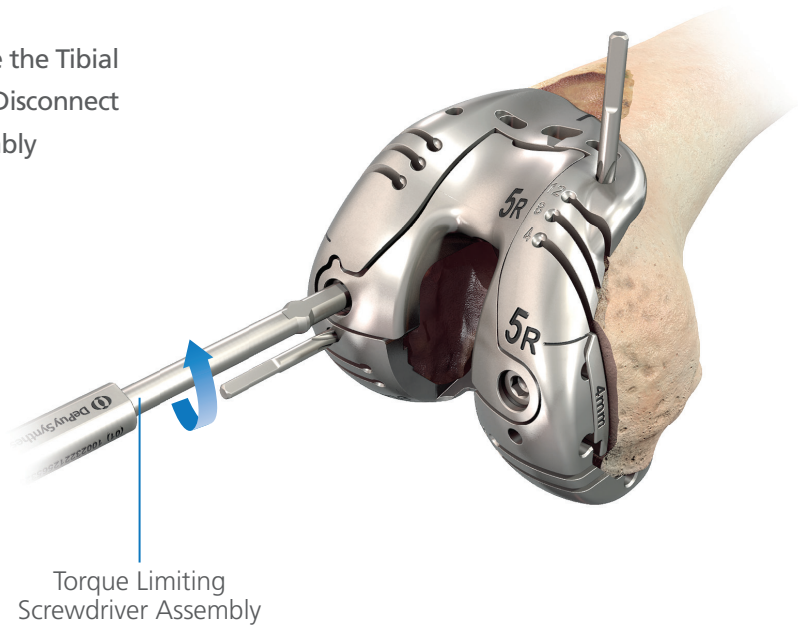

Slide the wide end of the Angel Wing in to the slot on the anterior flange between the Cut Through Trial and IM Connector and lever the IM Connector distally.

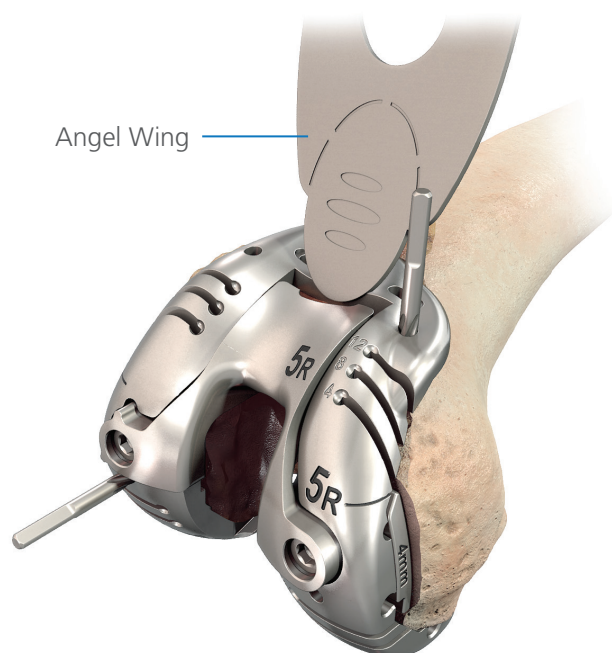

Femoral Preparation

Box Resection



Cut Through Trial



Straight Stem



Offset Stem

A Reciprocating Saw is recommended for resecting the sides of the Femoral Box. Use the side walls of the box opening on the Cut Through Trial as a Guide.

Attach the Box Cut Platform to the anterior flange of the Cut Through Trial and proceed to resect the top of the box with the Reciprocating Saw or Narrow Saw Blade.

A groove is machined into the bridge between the posterior condyles, once the top of the box resection has been completed this groove is fully visible.

Check completeness of the box resection using the Angel Wing against the Box Cut Platform and along the sides of the box opening in the Cut Through Trial.



Remove the Box Cut Platform and the Cut Through Trial from the prepared femur.

For Femoral Trial Assembly with a Straight or Offset Stem, proceed to **page 139**.

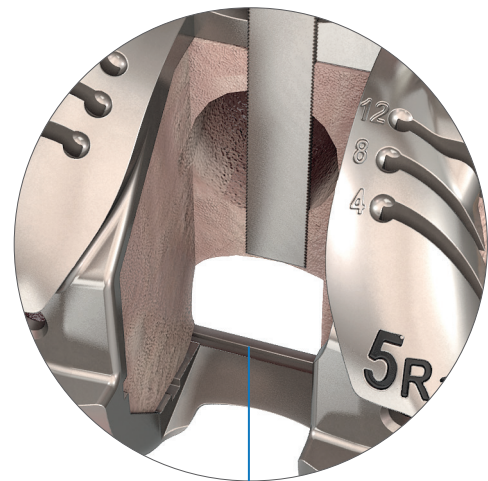
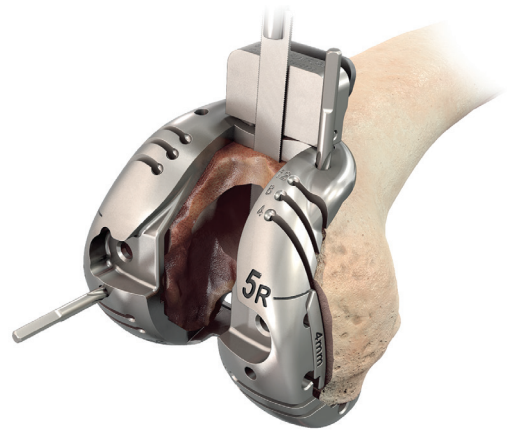
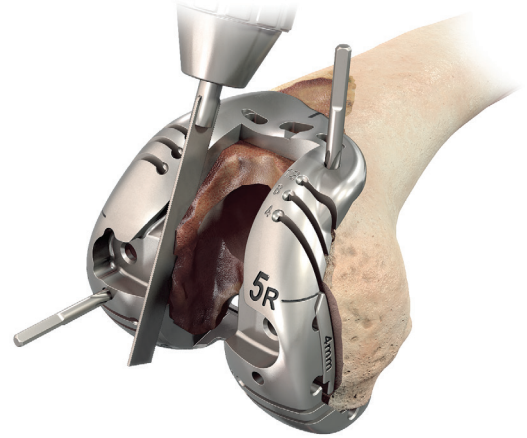

Machined Groove on Bridge



CAUTION

If the box resection is not complete, the connecting components may not seat.

Femoral Preparation

Seating the Femoral Trial



Cut Through Trial



Straight Stem



Offset Stem

Assemble the Femoral Trial, Box Trial, Stem Trial Bolt, Boss Trial or Offset Adaptor Trial, and Stem Trial as described in **pages 55 and 57** and any appropriate Augment Trials as described on **page 60**. 

If offset is being used, position the Femoral Offset Adaptor Trial to the offset orientation previously noted in the Cut Through Trial with Offset Stem workflow from **pages 129 to 131**, and tighten the Stem Trial Bolt.



Introduce the Femoral Trial Assembly to the prepared femur. Utilize the ATTUNE System Impactor to seat the Femoral Trial Assembly.

Introduce the Revision Tibial Insert Trial and proceed to **Setting Tibial Base Rotation on page 151** or if it is now desired to add a Sleeve to the construct, proceed to **page 140**.



CAUTION

The ATTUNE Revision Femoral Augment Trials contain magnets. These devices should be kept at a safe distance from a patient's active implantable medical device(s) (i.e. pacemaker) in order to avoid adversely affecting the device. The Femoral Augment Trials should be kept at an appropriate location when not in use in the surgical site.



Femoral Preparation

Broaching



Cut Through Trial



Femoral Sleeve and Stem

The following workflow is for an intraoperative transition from a well balanced Cut Through Trial with a Long Straight Stem to a Sleeve and Stem Preparation using the Cut Through Trial.



INFORMATION

Prior to continuing with this workflow the Straight Stem workflow must be completed.

Once the flexion and extension gaps have been established through the Cut Through Trial **and the box resection has been performed** proceed with the following steps for Broach Preparation.

Translate the lines on the medial, lateral sides and anterior flange of the Cut Through Trial onto the distal femoral bone.

These lines represent the A/P and M/L positions of the Femoral Boss and shall correspond with the desired Broach axis as the subsequent Broaching steps are performed. See image on [page 144](#).

Connect the lines on the medial and lateral femur across the distal surface of the femur.

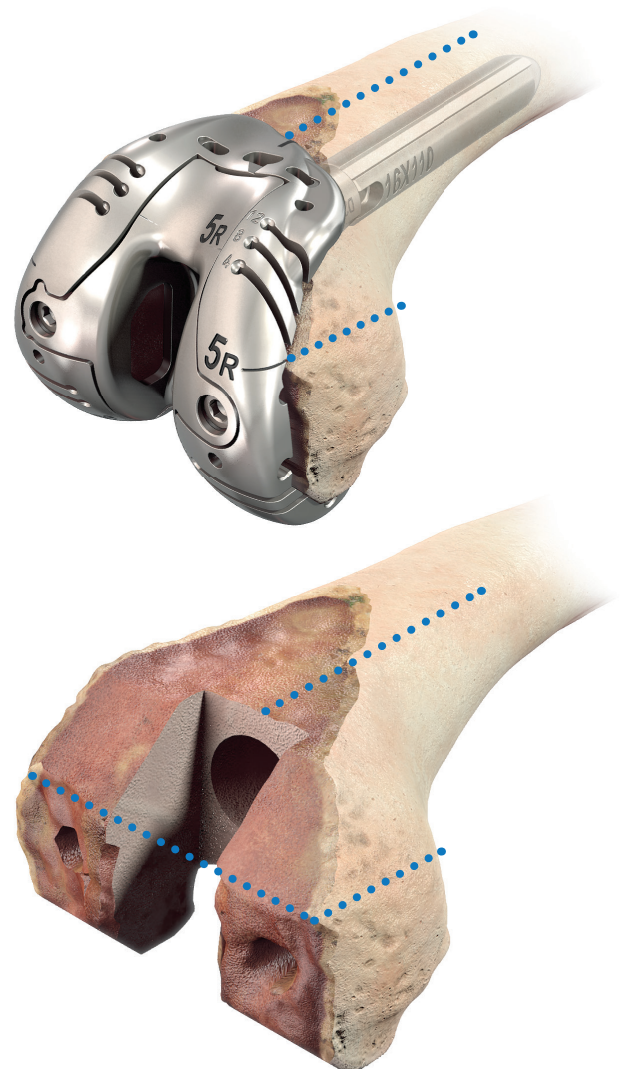

Femoral Preparation

Broaching



Cut Through Trial



Femoral Sleeve and Stem

Revisit the Femur Reference Tool to ensure that the femoral canal has been reamed to the appropriate depth for a Femoral Broach and Stem.

Example of Reamer Reference Tool use for Press-Fit Stem and Femoral Sleeve:

The Cut Through Trial assessment was performed with a 110 mm Stem Trial and Pre-operative Planning suggested use of a 55 mm Sleeve. To accommodate the Sleeve within the overall construct length, a 60 mm Stem should now be used instead of the 110 mm Stem.

Ream to Groove 6. The resultant implant construct (Femoral Component, 60 mm Stem, 55 mm Femoral Sleeve) will align with the Femoral Sleeve Trial construct but will be slightly longer than the 110 mm Stem Trial *without sleeve* as can be seen by comparing the position of the 55 mm Sleeve and 60 mm Stem versus the 110 mm Stem without Sleeve on the Reamer Reference Tool.

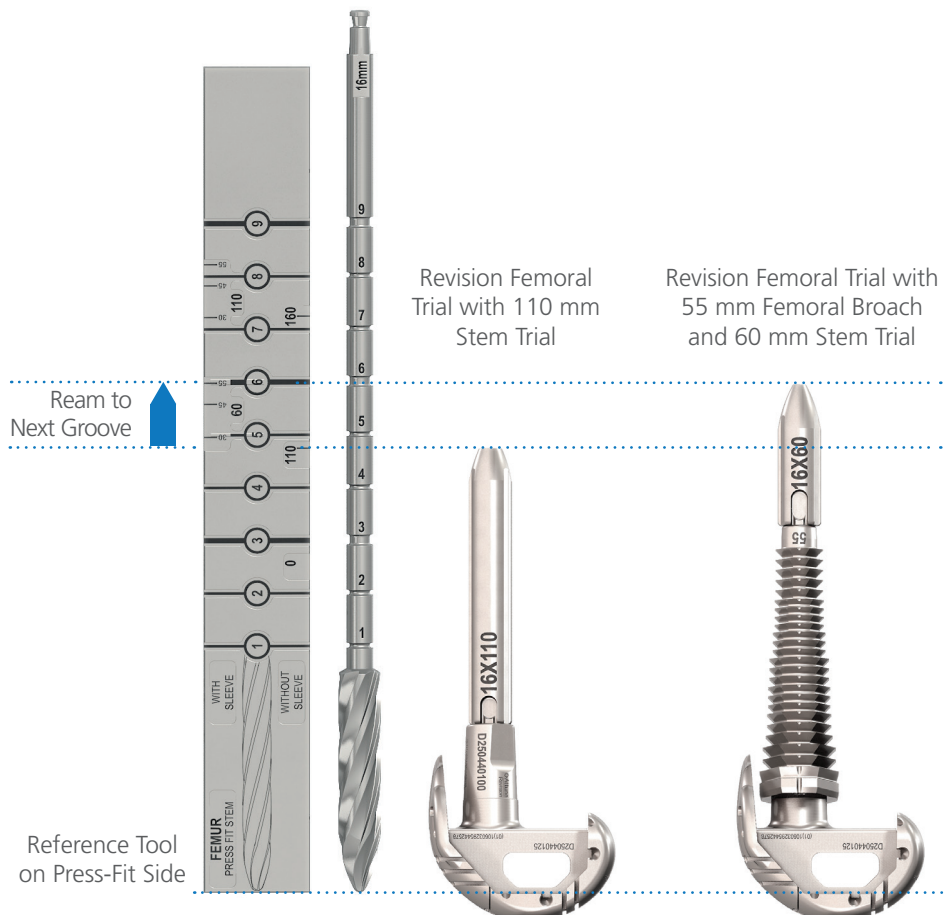

Femoral Preparation

Broaching



Cut Through Trial



Femoral Sleeve and Stem

Assemble the corresponding Stem Trial to the smallest Femoral Broach.

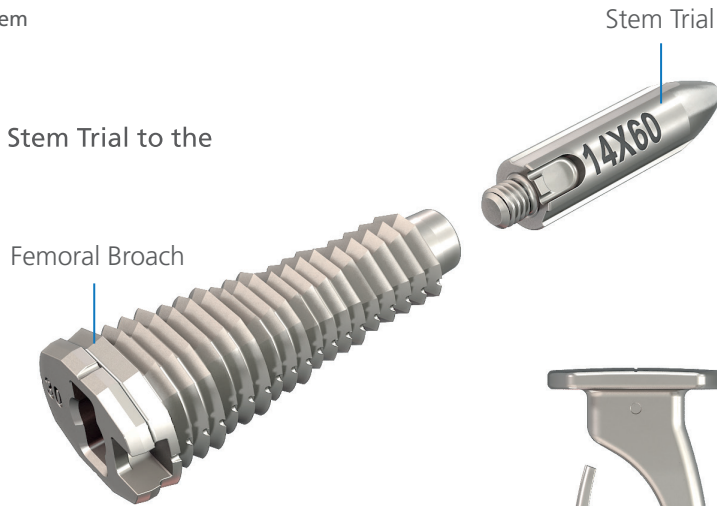

If utilizing the KINCISE™ Surgical Automated System for Femoral Broaching, proceed to Appendix A on Page 219.

Connect the correct side, "Left or Right", Broach Stop of the appropriate size grouping, 1 - 3, 4 - 7, 8 - 10, to the Revision Broach Handle.

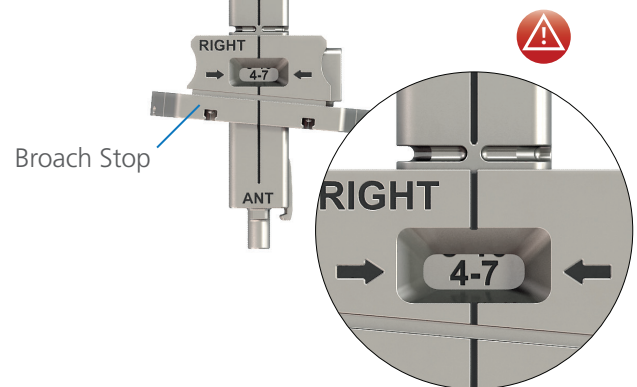

CAUTION

A Broach Stop must be utilized when broaching the femur.

Femoral Preparation

Broaching



Cut Through Trial



Femoral Sleeve and Stem

If Distal Augment Trials were utilized in the Cut Through Trial to achieve desired placement of the Femoral Component, apply the Broach Stop Shim that corresponds to the thinnest of the Distal Augment Trials utilized.

Example
8 mm Distal Medial and 4 mm Distal Lateral - Utilize the 4 mm Broach Stop Shim
8 mm Distal Medial and NO Distal Lateral - No Broach Stop Shim is to be applied

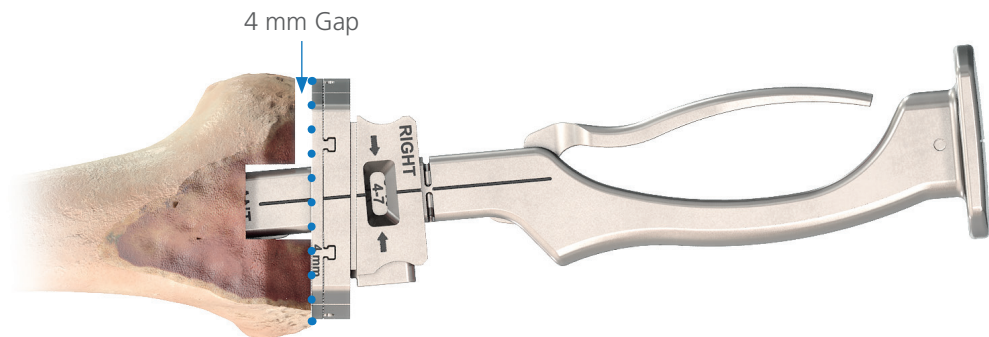
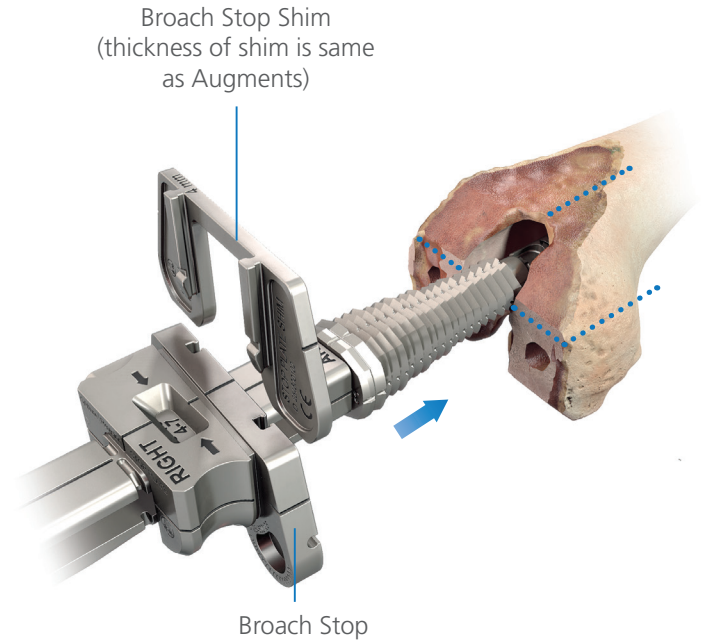

8 mm Distal Medial and 4 mm Distal Lateral

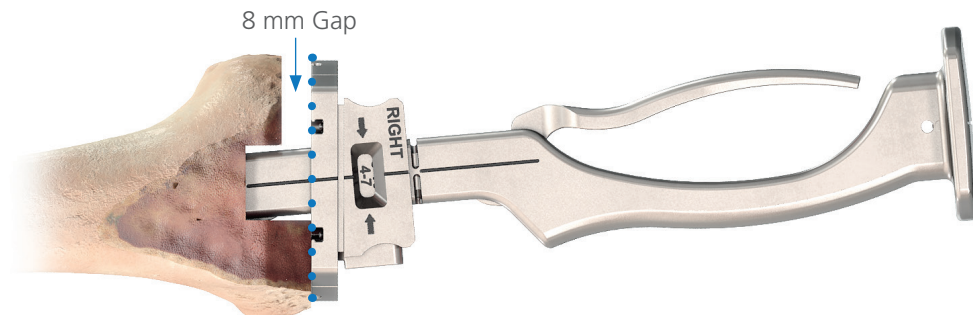

8 mm Distal Medial and NO Distal Lateral

Femoral Preparation

Broaching



Cut Through Trial



Femoral Sleeve and Stem

Connect the Broach Assembly to the Broach Handle Assembly.

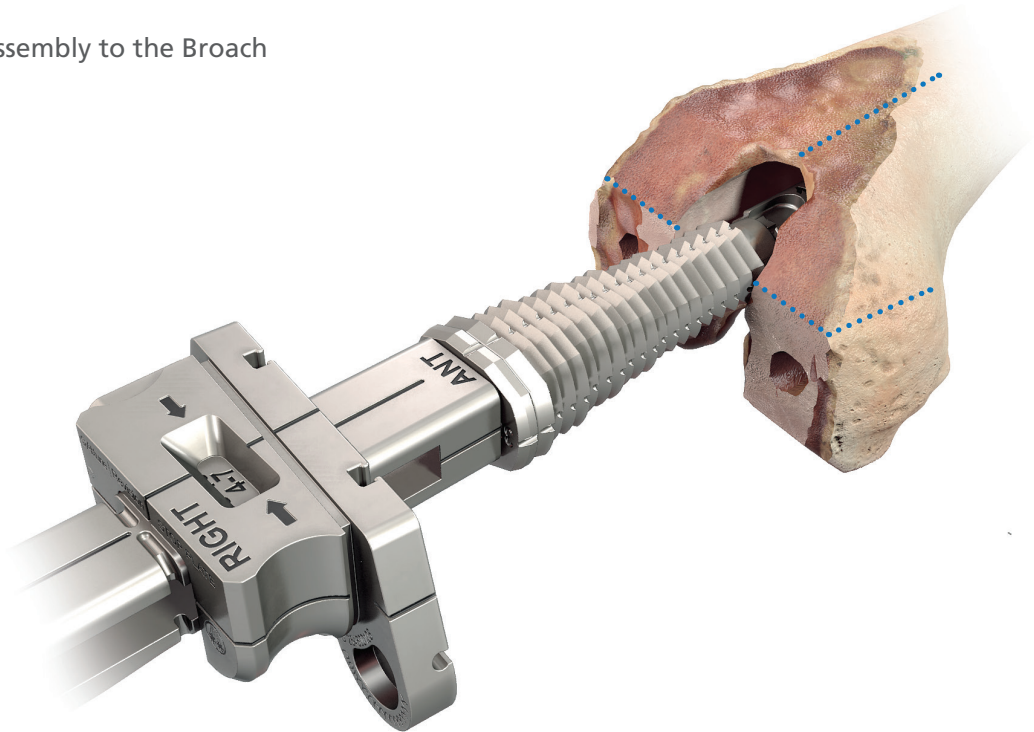

Femoral Preparation

Broaching



Cut Through Trial



Femoral Sleeve and Stem

Utilize the A/P reference line indicated on the distal femur along with the marking lines along the side of the Broach, Broach Handle and Broach Stop to aid in guiding the placement of the Femoral Broach during Broaching.

Frequently check that the A/P position indicated by the lines along the sides of the Broach, Broach Handle, Broach Stop, and/or Broach Stop Shims has not migrated anteriorly or posteriorly with respect to the A/P reference line on the distal femur.

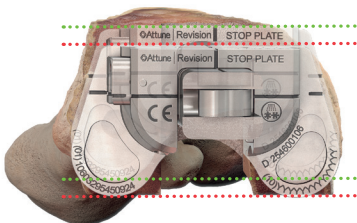
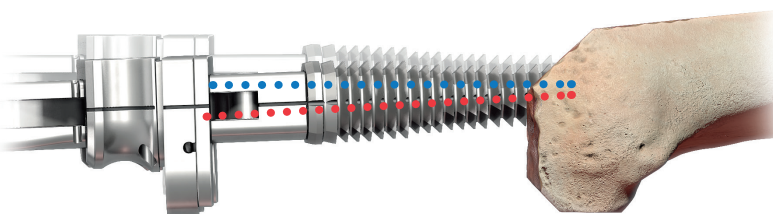
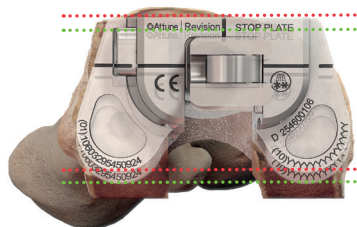
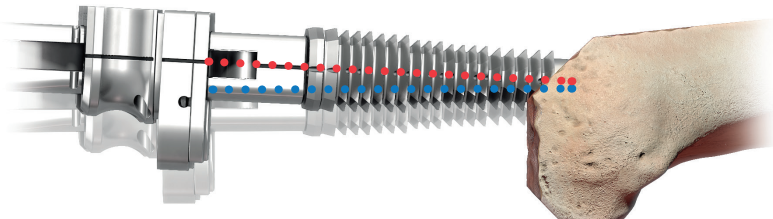
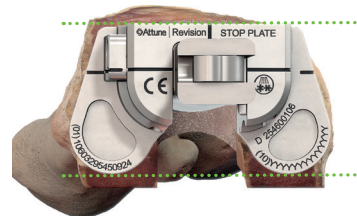
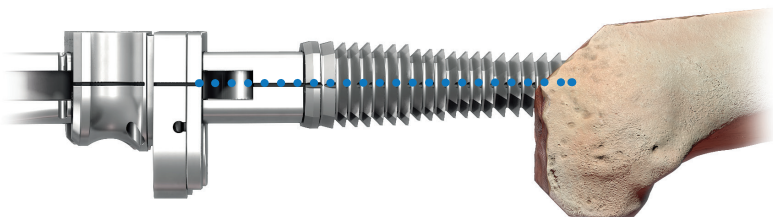

Femoral Preparation

Broaching



Cut Through Trial



Femoral Sleeve and Stem

If rotation is required for Femoral Broach fixation then the markings on the medial and lateral aspects of the Broach will not align to the markings on the femoral bone and the distance between the marked line on the femur and the line on the Broach should be equivalent on both the medial and lateral sides.

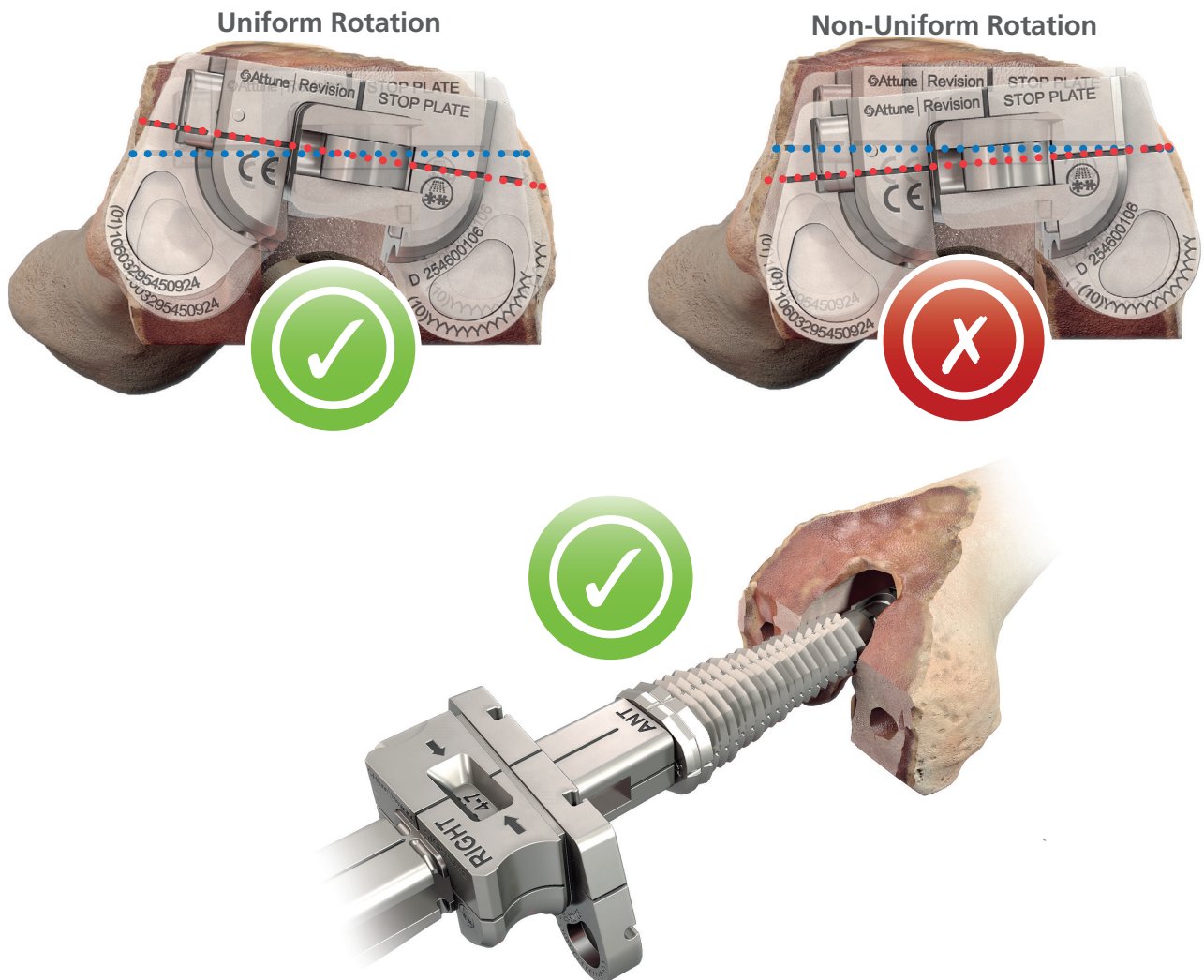

Femoral Preparation

Broaching



Cut Through Trial



Femoral Sleeve and Stem

Every effort in broaching should be made to align the markings on the Femoral Broach with those on the distal femur so that the position of the Femoral Component is not shifted.

		Options to Address Broach Positional Variation
Broach Positional Variation from Original Cut Through Trial with Stem Assessment	If the M/L position of the Broach shifts	The Conventional Cut Guide and Notch Guide should be utilized to re-prepare the box resection in the correct M/L placement Assess bone coverage and potential overhang/underhang introduced by new M/L position
	If the Broach shifts anteriorly	Assess the impact to the flexion space and potentially upsize the Femoral Component. Assess potential overhang of the new femoral size If upsizing is not possible, assess the need to resect more posterior bone and/or increase the Insert thickness and proximalize the Broach
	If the Broach shifts posteriorly	Assess the impact to the anterior cortex as well as the flexion space and potentially downsize the Femoral Component. Assess potential overhang/underhang/notching of the new femoral size If downsizing is not possible, assess the need to resect more anterior bone, decrease the Insert thickness, and distalize the Broach by increasing the Broach size and utilizing the Broach Stop Shims
	If the Broach non-uniformly rotates with respect to the A/P reference line. For example see previous page	This will result in either anterior or posterior shift of the Broach. See the above options to address either shift
	If the Broach uniformly rotates with respect to the A/P reference line. For example see previous page	No adjustment is necessary

For Sleeve/Femoral Component compatibility, refer to page 87.



INFORMATION

With the construct change from a femur with a long Stem to a femur with a Sleeve and shorter Stem, one can anticipate there may be some subtle changes in the position of the femur.

Femoral Preparation

Broaching



Cut Through Trial



Femoral Sleeve and Stem

Advance the Broach until the Broach Stop, or Broach Stop Shim is seated on the most prominent surface of the distal femur.

Check that the Broach is rotationally stable. If not, progressively increase the Broach size until rotational stability is achieved.

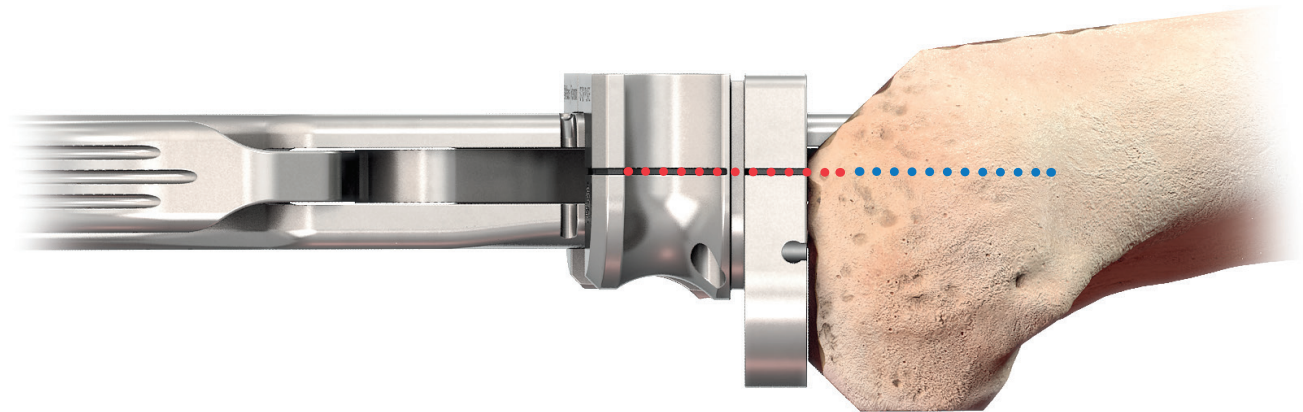
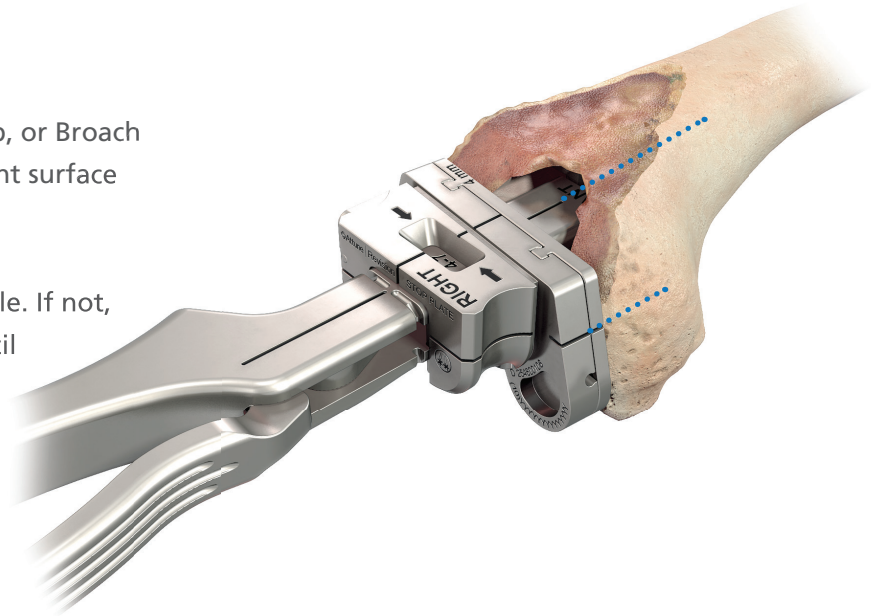

Femoral Preparation

Broaching



Cut Through Trial



Femoral Sleeve and Stem

After progressively broaching the femoral canal to stability, detach the Broach Handle.

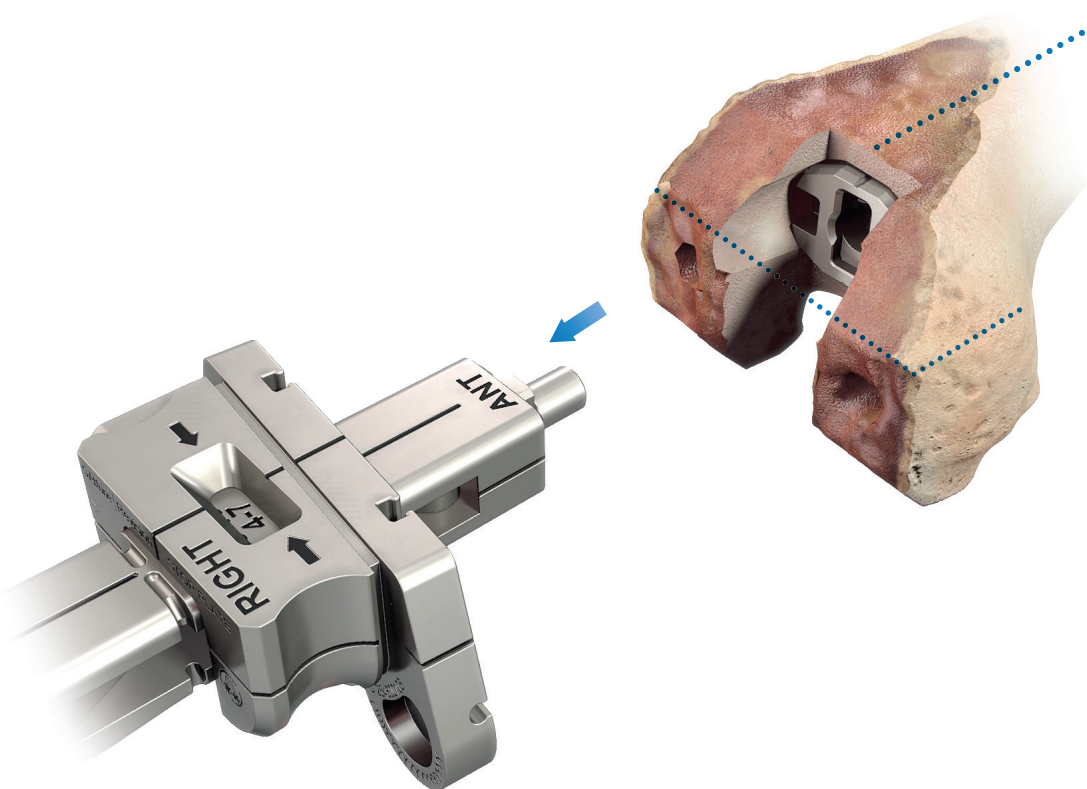

For Femoral Trial Assembly with a Broach, proceed to **page 150**.

Femoral Preparation

Seating the Femoral Trial



Cut Through Trial



Femoral Sleeve and Stem

Assemble the Femoral Trial with the Box Trial and any appropriate Augment Trials as described on **page 60**.

Introduce the Femoral Trial Assembly to the prepared femur and introduce the Femoral Broach Trial Bolt through the hole in the Box Trial and into the Femoral Broach. Tighten with the Torque Driver with 6 mm Hex Driver.

Introduce the Revision Tibial Insert Trial and proceed to **Setting Tibial Base Rotation** on **page 151**.

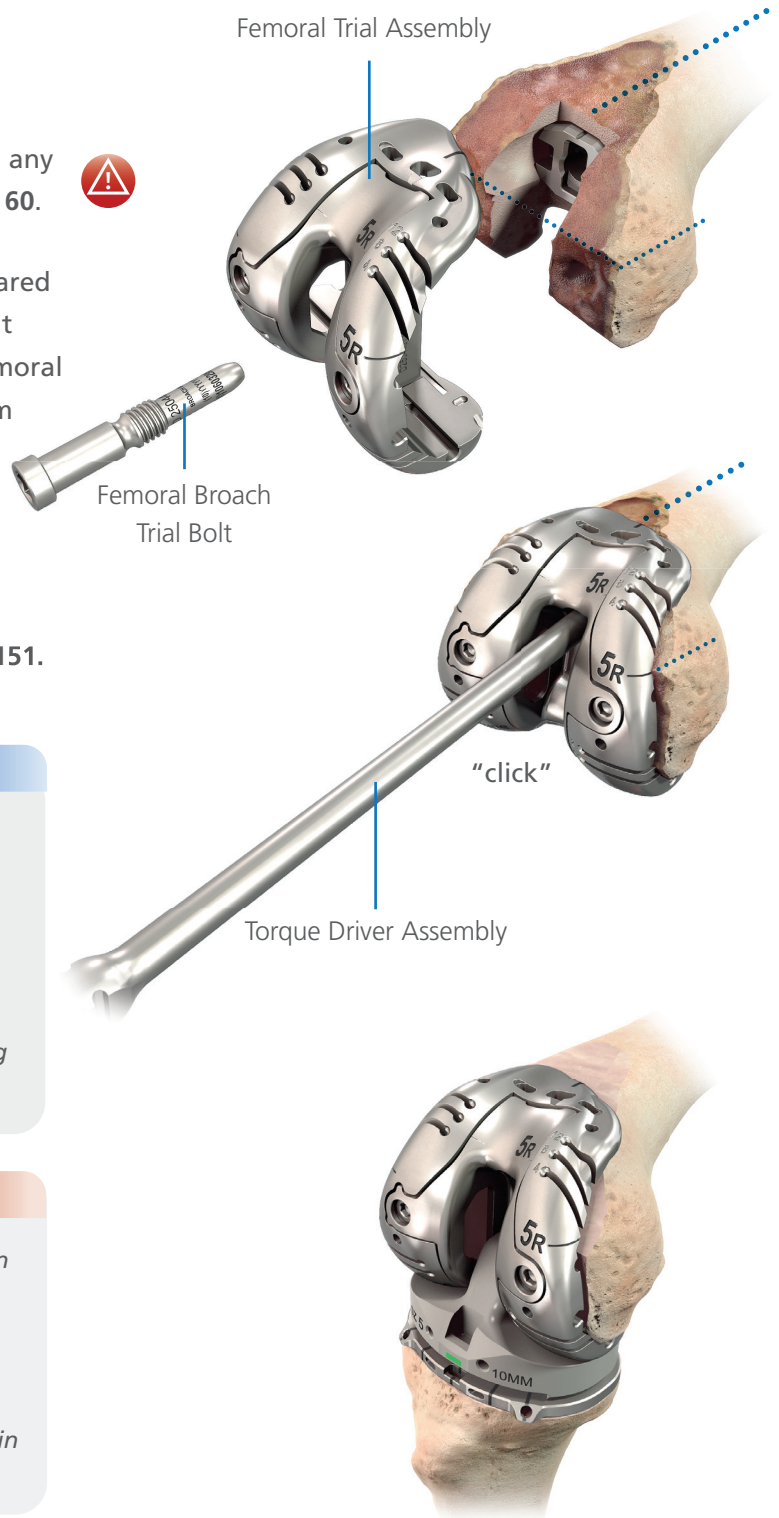

INFORMATION

If the Cut Through Trial Assembly and Broach Trial Bolt do not engage in the Broach, slightly extract the Broach with the Broach Handle, attach the Cut Through Trial Assembly to the Broach via the Broach Bolt leaving it slightly loose to allow the instruments to locate within the prepared cavity, and advance the trial construct until seated to the prepared depth using the ATTUNE System Impactor.



CAUTION

The ATTUNE Revision Femoral Augment Trials contain magnets. These devices should be kept at a safe distance from a patient's active implantable medical device(s) (i.e. pacemaker) in order to avoid adversely affecting the device. The Femoral Augment Trials should be kept at an appropriate location when not in use in the surgical site.

Setting Tibial Base Rotation

Now set the Tibial Base rotation with the surgeon's preferred technique. Options include:

- Alignment with the medial third of the Tibial Tubercle
- Optimizing Tibial Base rotation based on trial reduction with the Tibial Insert Trial and Femoral Component



Cut Through Trial



Solid Femoral Trial

Setting Tibial Base Rotation

Optimizing the Tibial Base Rotation Based on a Trial Reduction

With the knee in flexion, introduce the Tibial Insert Trial between the Femoral Trial and Revision FB Tibial Base Trial.

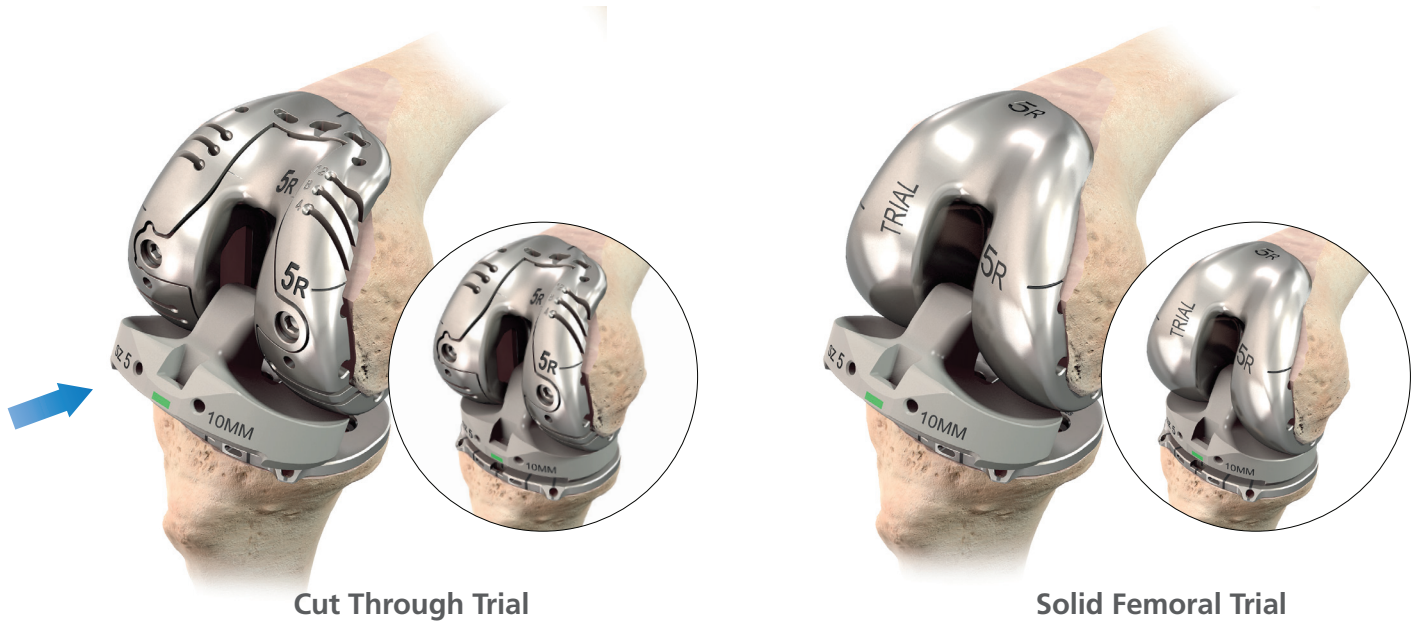

Cut Through Trial

Solid Femoral Trial

Extend the knee carefully, noting the A/P and M/L stability, and the overall alignment in the A/P and M/L planes. While taking the knee from flexion to extension, observe the orientation of the FB Tibial Base Trial.



Cut Through Trial

Solid Femoral Trial

Setting Tibial Base Rotation

When the definitive orientation of the FB Base Trial has been determined, with the knee in flexion, either pin the trial in place through the medial anterior fixation hole or utilize the marks on the anterior aspect of the FB Tibial Base Trial to mark the rotation with respect to the anterior tibia.

If a medial Tibial Augment is required, and the Anterior Fixation Pin is desired then pin through the lateral anterior hole.



Cut Through Trial



Solid Femoral Trial

Setting Tibial Base Rotation

To remove the Tibial Insert Trial, fully flex the knee and connect the ATTUNE Primary INTUITION Insert Trial Handle to the anterior features on the Tibial Insert Trial and pull assembly out of the joint space to remove the Tibial Insert Trial.

If Tibial Augment preparation is required, proceed to **page 155**.

If Tibial Augments are not required or have been prepared previously in the procedure, proceed to Keel Preparation on **page 157**.

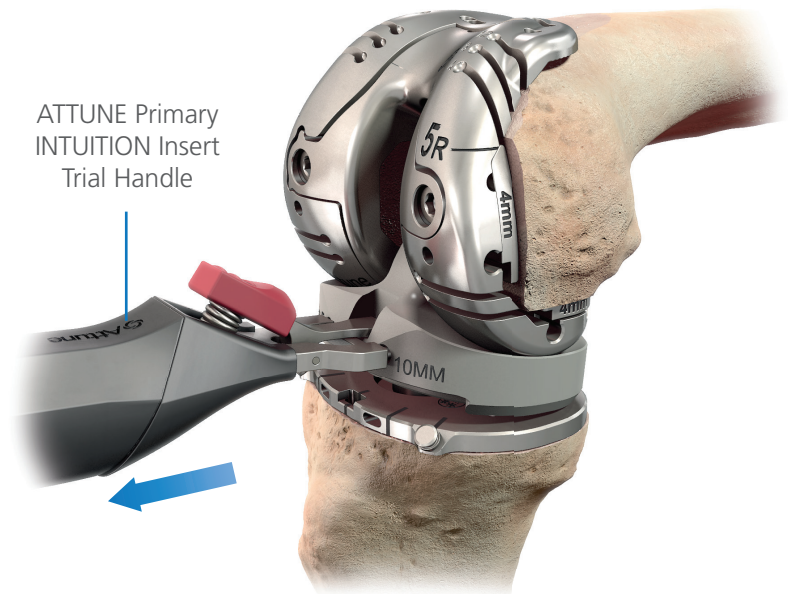

Cut Through Trial

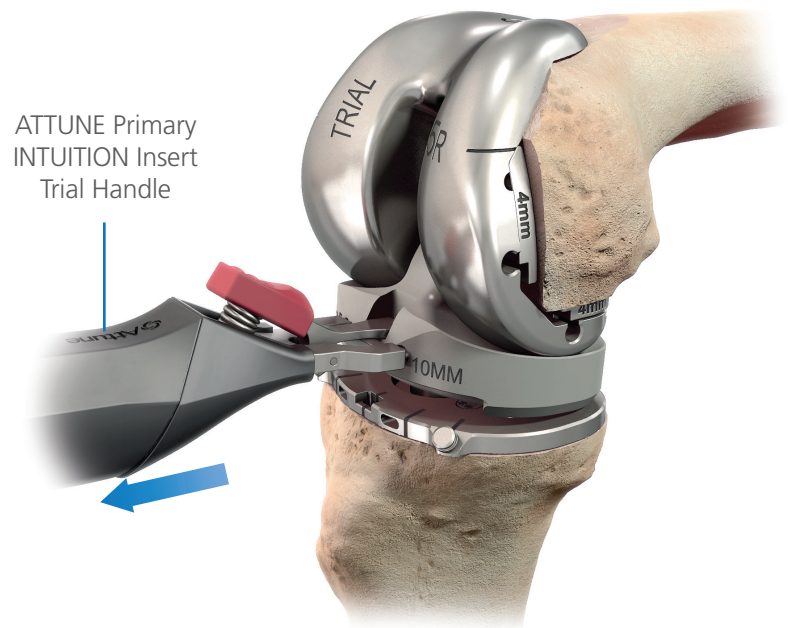

Solid Femoral Trial

Tibial Augment Preparation

With the FB Base orientation determined, Tibial Augment resection may be performed at this time if it has not previously been prepared.

Ensure no Pins are in the way of the Augment resection. Assemble the Revision Base Mount with the Tibial Base Trial.

Assemble the Cutting Block Mount to the Revision Tibial Cutting Block and connect to the Base Mount.

Make the appropriate Augment resection taking care to maintain proper tibial rotation.

The "0" (zero) slot is aligned with the bottom surface of the tray. It does not allow for a clean-up resection at this stage; to perform a clean-up resection return to either **page 33** for EM Tibial Resection or **page 42** for IM Tibial Resection.

Once any necessary Tibial Augment resections are complete, remove all Tibial Augment resection instruments.

Should Lateral Augments be required, if exposure permits, utilize the opposite leg Tibial Cutting Block.

Ensure all bone debris is cleared from the joint space.

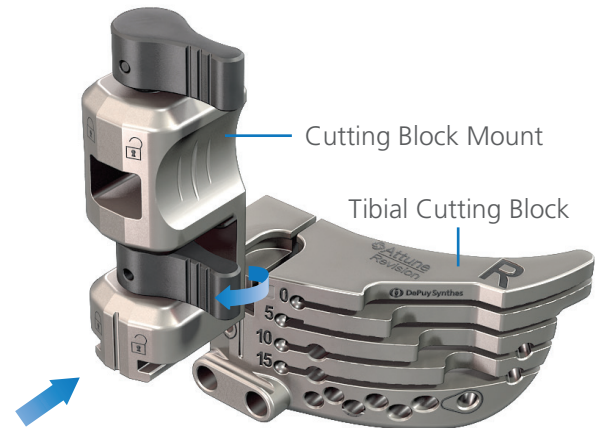
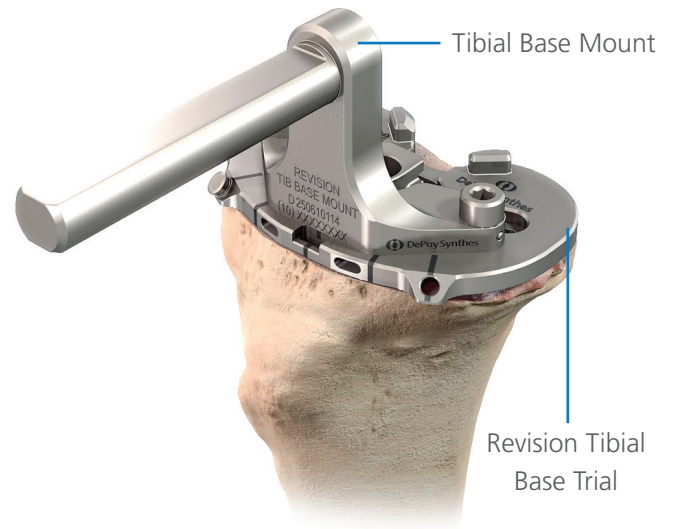

i INFORMATION

To complete the Augment resection, the Tibial Base Trial and additional tibial instrumentation may need to be removed from the bone after pinning the Cutting Block in place. The vertical slot in the central aspect of the Tibial Cutting Block may aid in initiating the center line of the Tibial Augment resection.

Tibial Augment Preparation

If Tibial Augments have been prepared, assemble the appropriate Tibial Augment Trial to the correct side of the Revision FB Base Trial with the Torque Limiting Screwdriver Assembly.

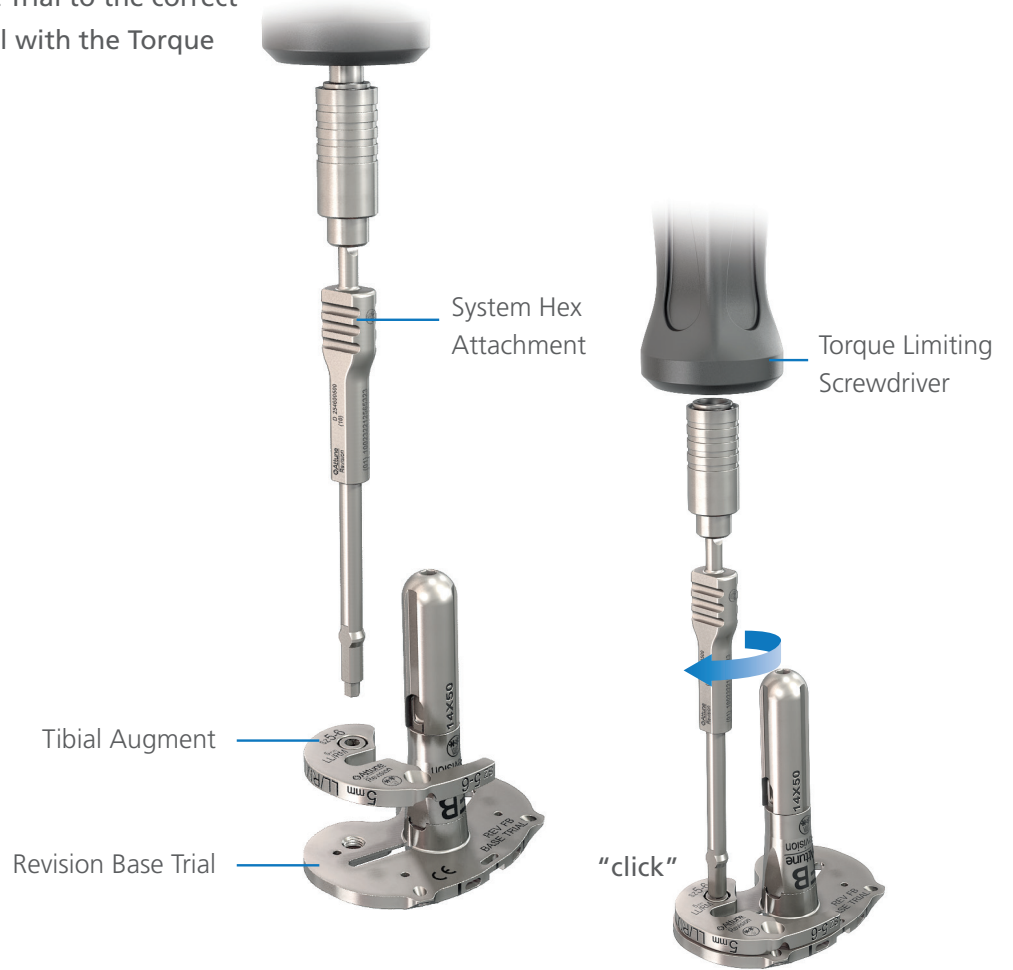

Place the Revision FB Base Trial assembly back onto the tibia to check the fit.

For Keel Preparation, proceed to **page 157**.



Keel Preparation

Attach the Revision Keel Punch corresponding to the correct tibial size grouping (1 - 2, 3 - 5, 6 - 8, and 9 - 10) to the Revision System Handle.



Impact the Keel Punch into the cancellous bone in the correct alignment until the Keel Punch is fully seated with the Tibial Base Trial. Remove the Keel Punch and Handle.

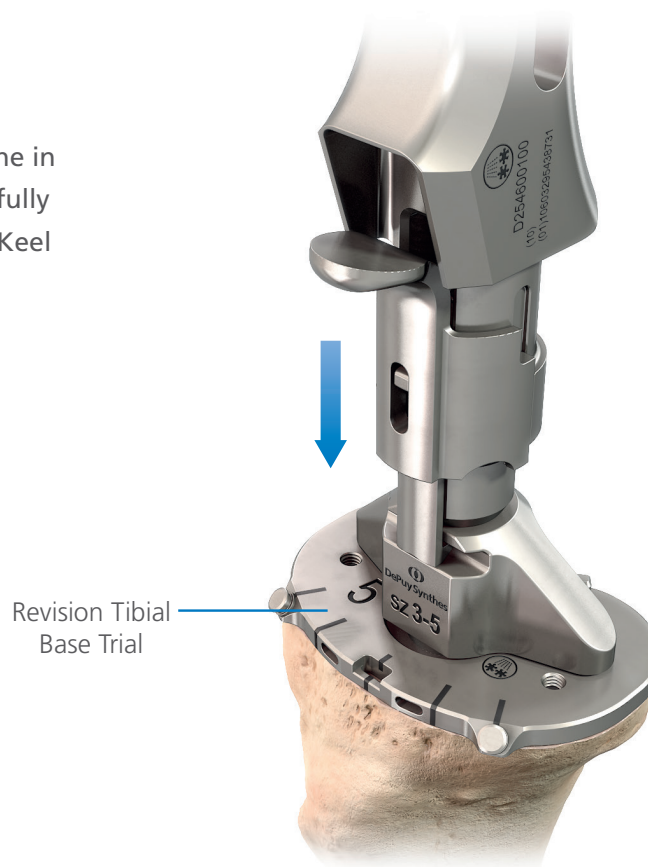

Patella Resection and Preparation – Instrument Assembly

Patella Resection Guide

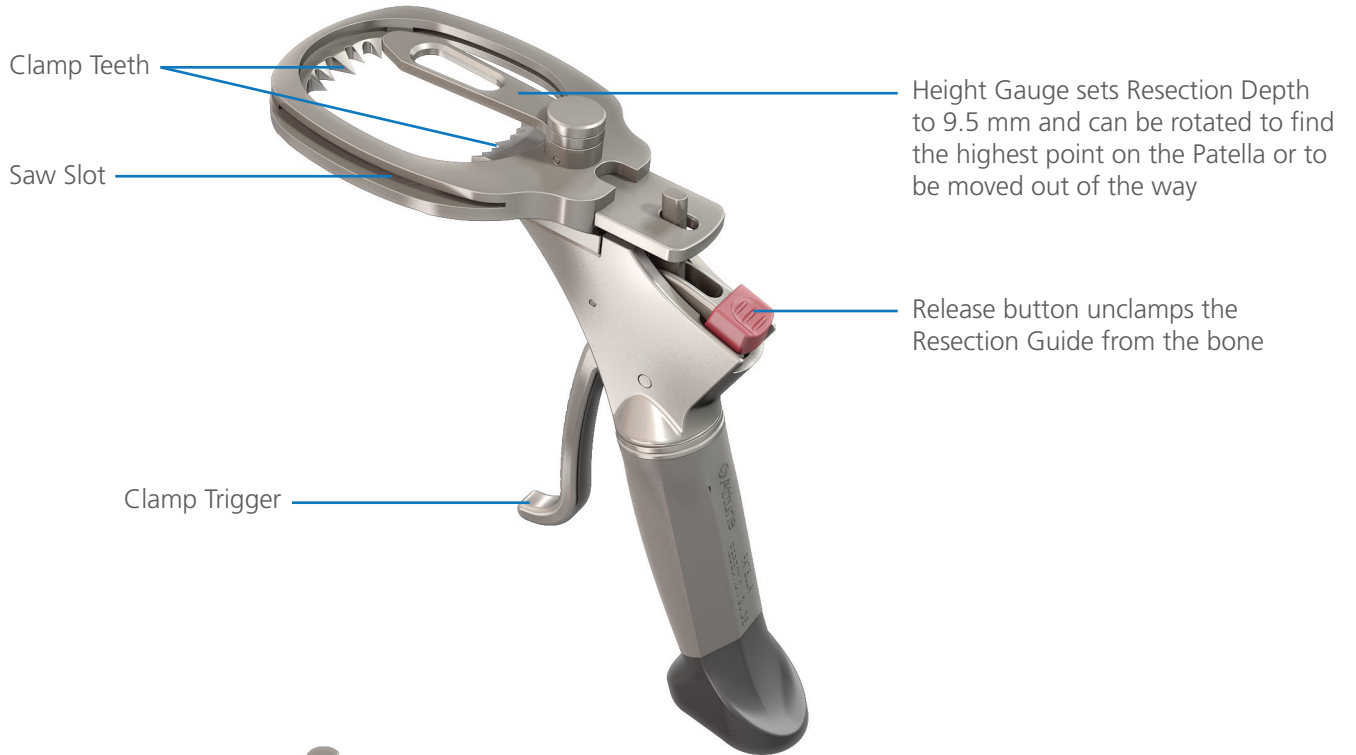

Patella Drill Trials

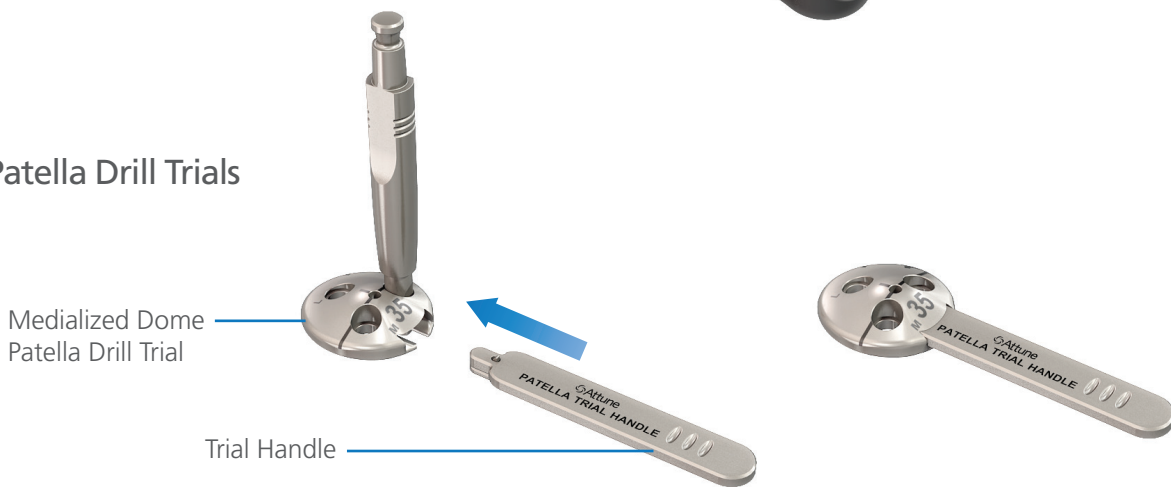

Assemble by inserting the Trial Handle into the slot on the Drill Trial until it clicks into place.

Patella Resection and Preparation – Instrument Assembly

Patella Drill Clamp

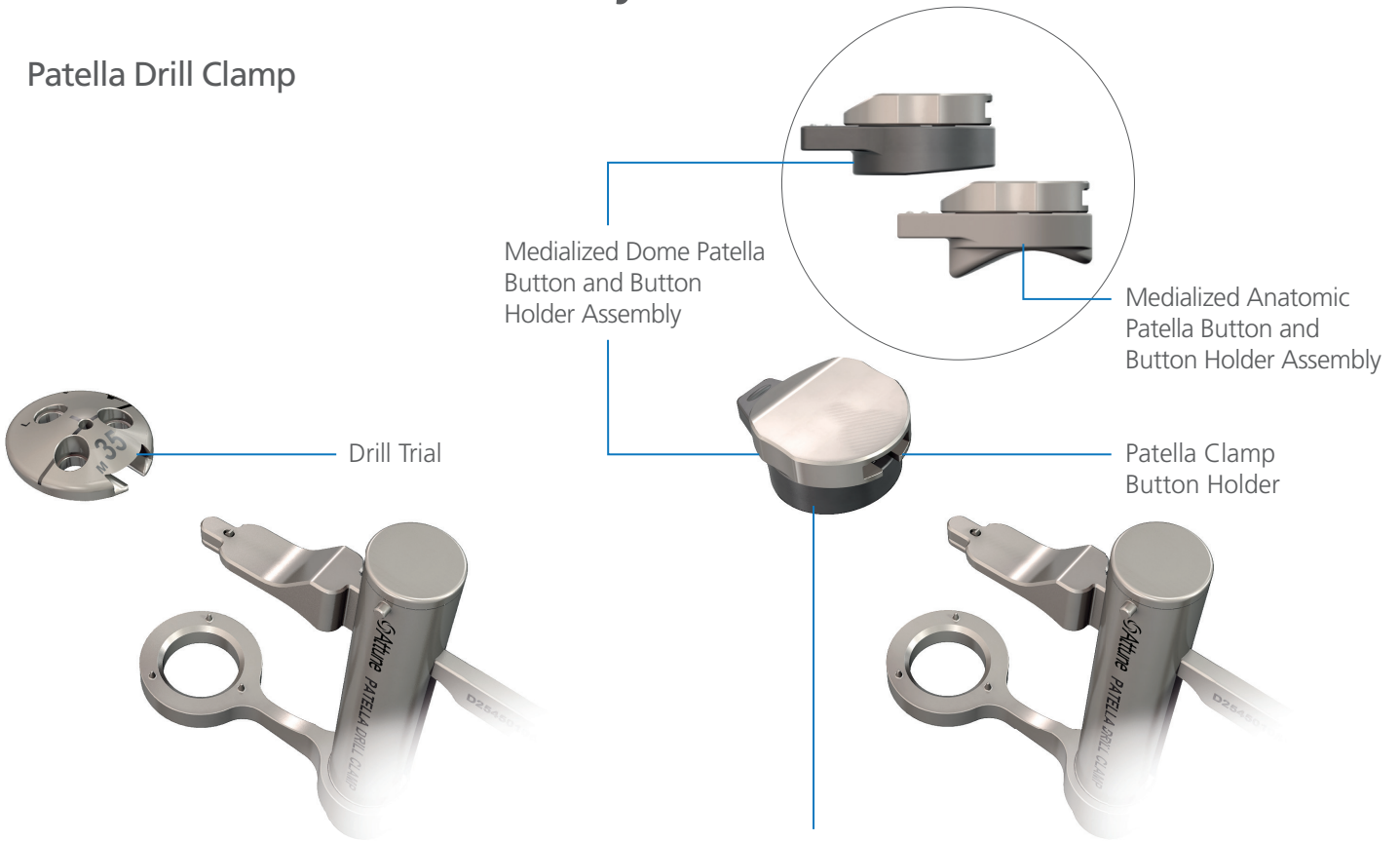

A Medialized Dome or Medialized Anatomic Silicone Button is assembled to the Patella Clamp Button Holder to protect the implant surface during cement pressurization

Clamp Connection Post attaches to either the Drill Trials or Patella Clamp Button Holder with a snap-on mechanism

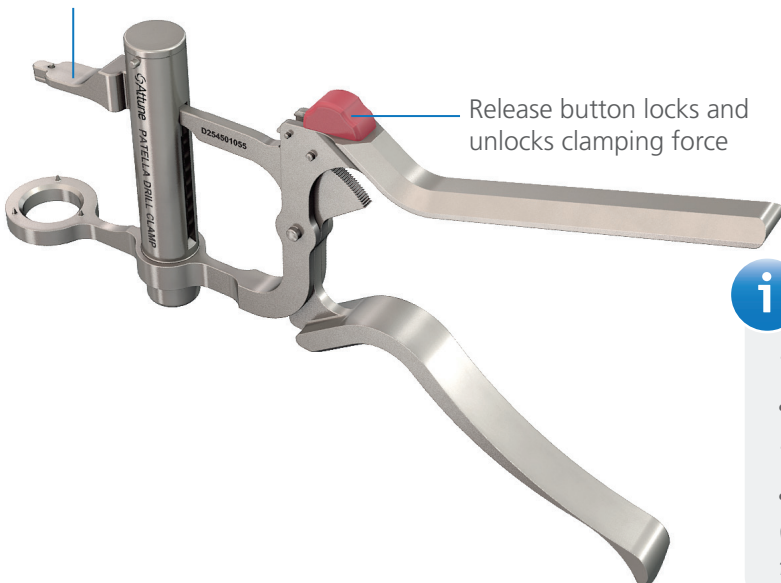

i INFORMATION

The patella instrumentation is designed for a medial approach only.

The clamp and trial handle are designed for a medial approach only. The Resection Guide and Drill Trials (used as stand alone without the clamp) can be used for a medial or lateral approach.

Patella Resection



Use the Caliper to estimate the thickness of the patella and evaluate the level of bone resection. The Height Gauge on the Patella Resection Guide accounts for a resection of 9.5 mm of bone, which is the average thickness of the ATTUNE Knee Systems Patellae.



Patella Guide Shim



Place the leg in extension and evert the patella.

Position the Patella Resection Guide so the Height Gauge is against the articular surface of the patella. Align the serrated jaws at the medial and lateral margins of the articular surface. Engage the largest tooth on the lateral side then engage the largest tooth on the opposite side to temporarily secure the clamp while allowing for rotation of the patella until the inferior and superior orientation is achieved and clamp fully.



CAUTION

If the patellar thickness is less than 21.5 mm, the thickness of the bone remaining after resection would be less than 12 mm and resecting less bone should be considered.

If less resection is required, the Patella Guide Shim is available which reduces the depth of the resection to 7.5 mm.



INFORMATION

The resection extends from the medial chondro-osseous junction to the lateral chondro-osseous junction.

Patella Resection



Perform the resection using an Oscillating Saw through the Saw Capture.

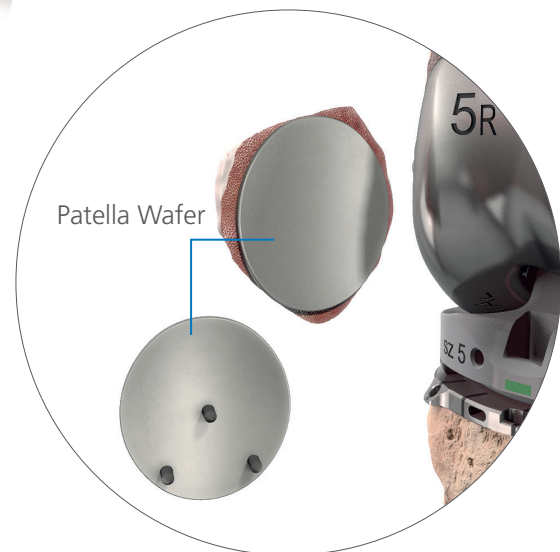

If desired, place a Patella Wafer on the resected surface by hand to protect the patellar bone bed.



INFORMATION

When resecting the patella, care should be taken to avoid Saw Blade excursion into the Femoral Trials or Implants.

Patella Implant Options



Medialized Anatomic Patella



Medialized Dome Patella

Patella Size Chart	
Size	Thickness
29	8.5 mm
32	9 mm
35	9.5 mm
38	10 mm
41	10.5 mm

Two patella options are available, the Medialized Dome Patella or the Medialized Anatomic Patella.

The Medialized Anatomic Patella is designed to be conforming with the Femoral Component and has a built in range of +/- 15 degrees freedom of rotation from its optimal position. Therefore, accurate alignment of the Patella Drill Trial is important for proper patella placement and tracking.

The following steps will aid in accurate alignment of both patella designs, but is particularly critical for the Medialized Anatomic Patella.

Patella Drill Trialing

If used, remove the Patella Wafer from the patella. Place the Patella Drill Trial on the resected patella to assess bone coverage. Select the correct size of Patella Drill Trial for maximum patella bone coverage. Verify the medial lateral location of the patella implant apex relative to the native anatomy ridge.



Patella Drill Trialing

Press the trial onto the bone manually or with the Patella Modular Clamp and Clamp Ring to engage spikes.

The Drill Trials have one larger central spike to allow engagement of only the central spike so that the Drill Trial may be rotated about the central axis to aid in assessment of its optimal position prior to being fully seated on bone.

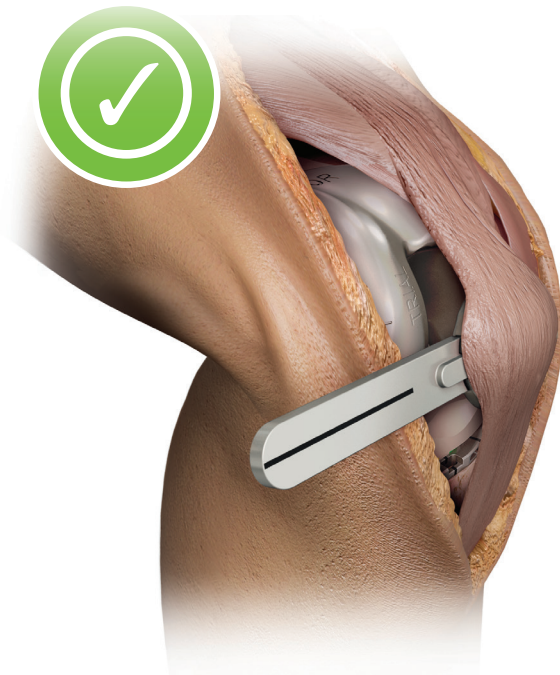
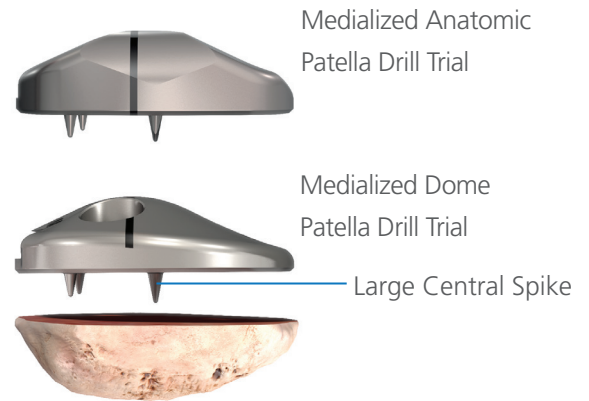

Correct trial handle alignment

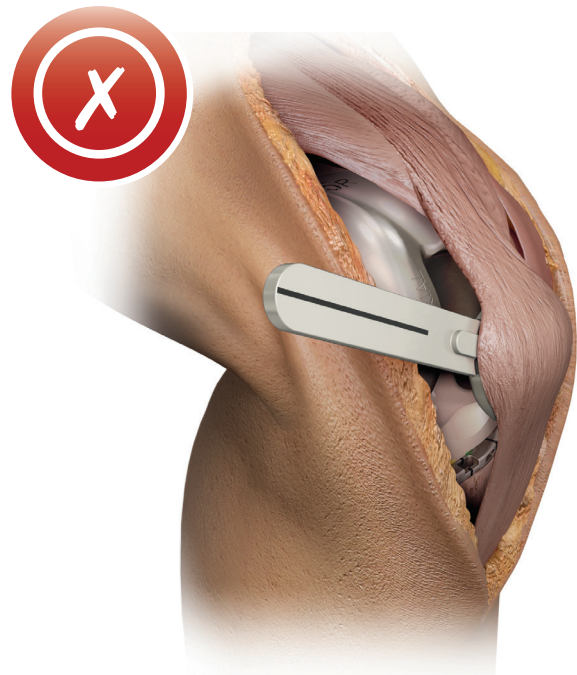

Incorrect trial handle alignment



INFORMATION

In a case where a short patella tendon raises concern about the Medialized Anatomic Patella contacting the top of the spine of the PS or Revision Insert, it is recommended to downsize the patella, superiorize and medialize its position. If that recommended positioning does not resolve the concern, the surgeon should consider using the medialized dome patella.

Lug Hole Preparation

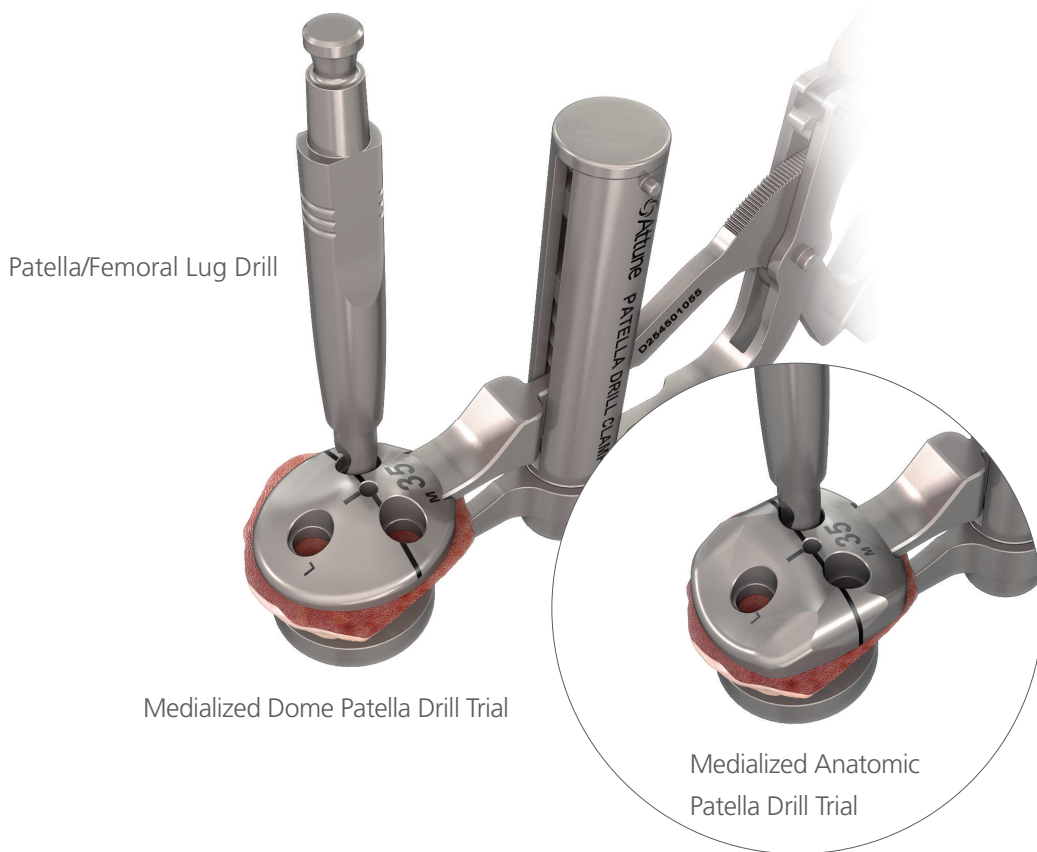

Use the Patella Modular Clamp to secure the Drill Trial if desired. Drill the holes using the Patella/Femoral Lug Drill.



CAUTION

If the surgeon is not satisfied with alignment or tracking of the Medialized Anatomic Patella Trial after drilling the peg holes, it is recommended to use a Medialized Dome Patella. The patella peg hole preparation is identical for the Medialized Dome Patella and the Medialized Anatomic Patella.

Final Trial Assessment

Complete final Trial evaluation and proceed to Trial removal on the following page.

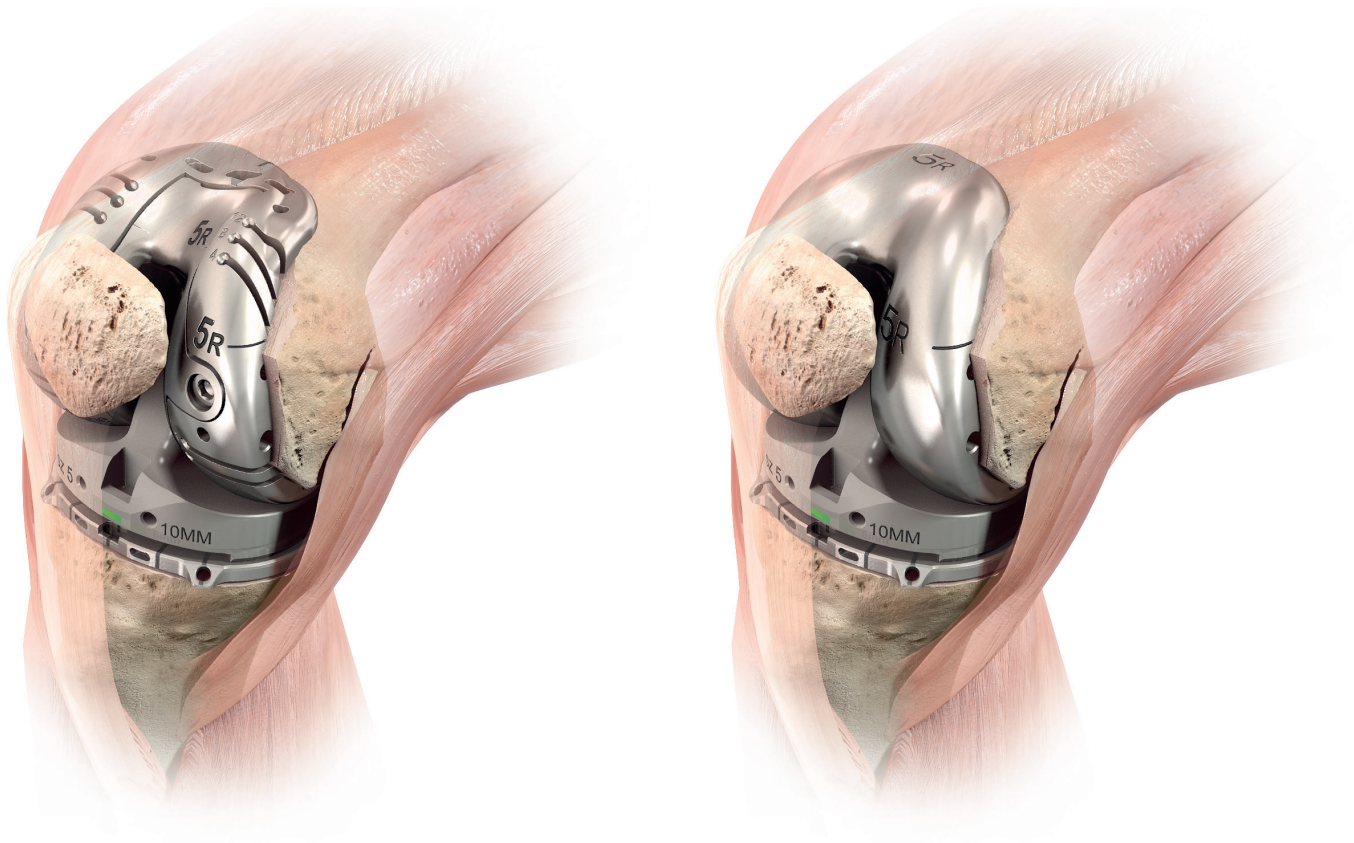

Femoral Trial Removal

Remove any Pins prior to extracting the Trial Assemblies.

Remove the Tibial Insert Trial using the ATTUNE Primary INTUITION Insert Trial Handle.

When using an Offset Adaptor or a Femoral Sleeve **ensure that the Central Bolt is tightened prior to extraction.**

To remove the Femoral Trial Assembly, assemble the Femoral Extractor to the Central Bolt feature of the Femoral Box Trial and extract from the prepared femur. If necessary, the Slap Hammer may be assembled to the Femoral Extractor to aid in Trial removal.

Retain the Trial Assembly to aid in setting rotation for final Implant Assembly.



INFORMATION

If the Broach or Offset Adaptor Trial loosens during extraction from the femur, then partially assemble the Trial back to the bone and tighten the Central Bolt to regain the correct Trial orientation. This will then be used to aid in setting the rotation of the final implant assembly.

Tibial Trial Removal

Remove any Pins prior to extracting the Trial Assemblies.

For Offset FB Base constructs **ensure that the Central Bolt is tightened prior to extraction.**

To remove the Revision FB Tibial Base Trial, assemble the Revision System Handle to the central feature of the FB Tibial Base Trial and extract from the prepared tibia.

Retain the Trial Assembly to aid in setting rotation for final Implant Assembly.

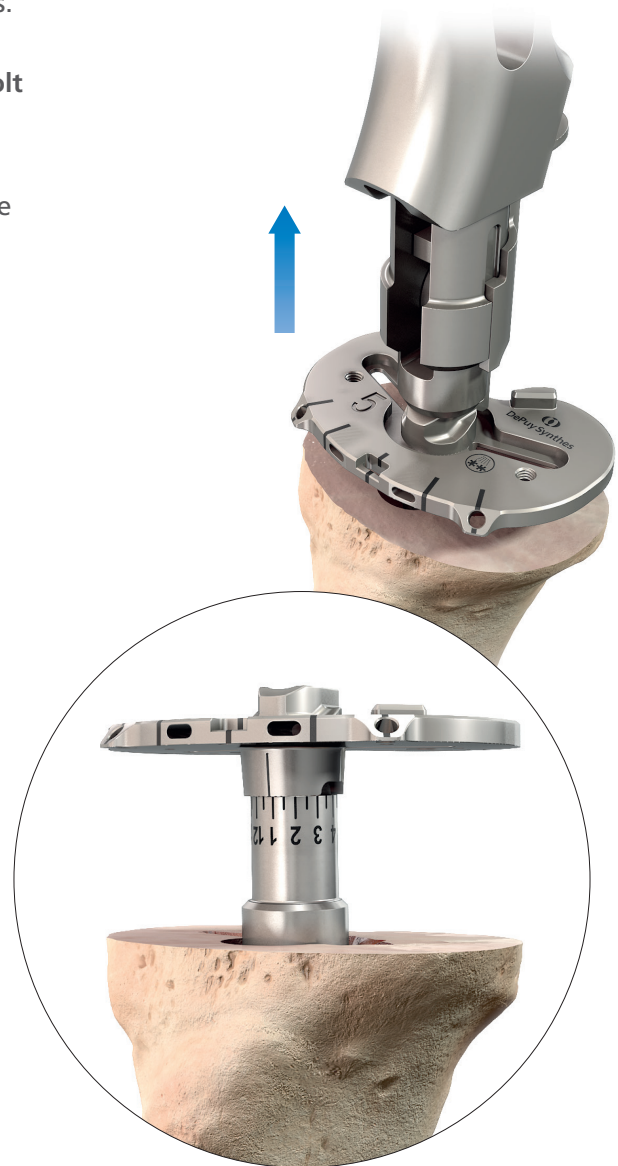

INFORMATION

If the Offset Adaptor Trial loosens during extraction from the tibia, then partially assemble the Trial back to the bone and tighten the Central Bolt to regain the correct trial orientation. This will then be used to aid in setting the rotation of the final implant assembly.

Implant Assembly

There are 14 Assembly Instruments in the system to aid in the building of the final Implant construct:

1. Revision Sleeve Impactor
2. Torque Driver
3. Augment 2.5 mm Wobble Bit
4. Implant Assembly Wrench
5. Assembly Wrench Adaptor
6. Assembly Base
7. Offset Stabilizer
8. Tibial Vice
9. Femoral Implant Post
10. Femoral Trial Post
11. Femoral Shim (1 per Femoral Component size)
12. Sleeve Counter Torque Wrench
13. Tibial Straight Stem Wrench
14. Femoral Straight Stem Wrench

After extracting the ATTUNE Revision Knee Trial from the prepared bone, **retain the assembled trial construct** to reference in the definitive Implant Assembly.

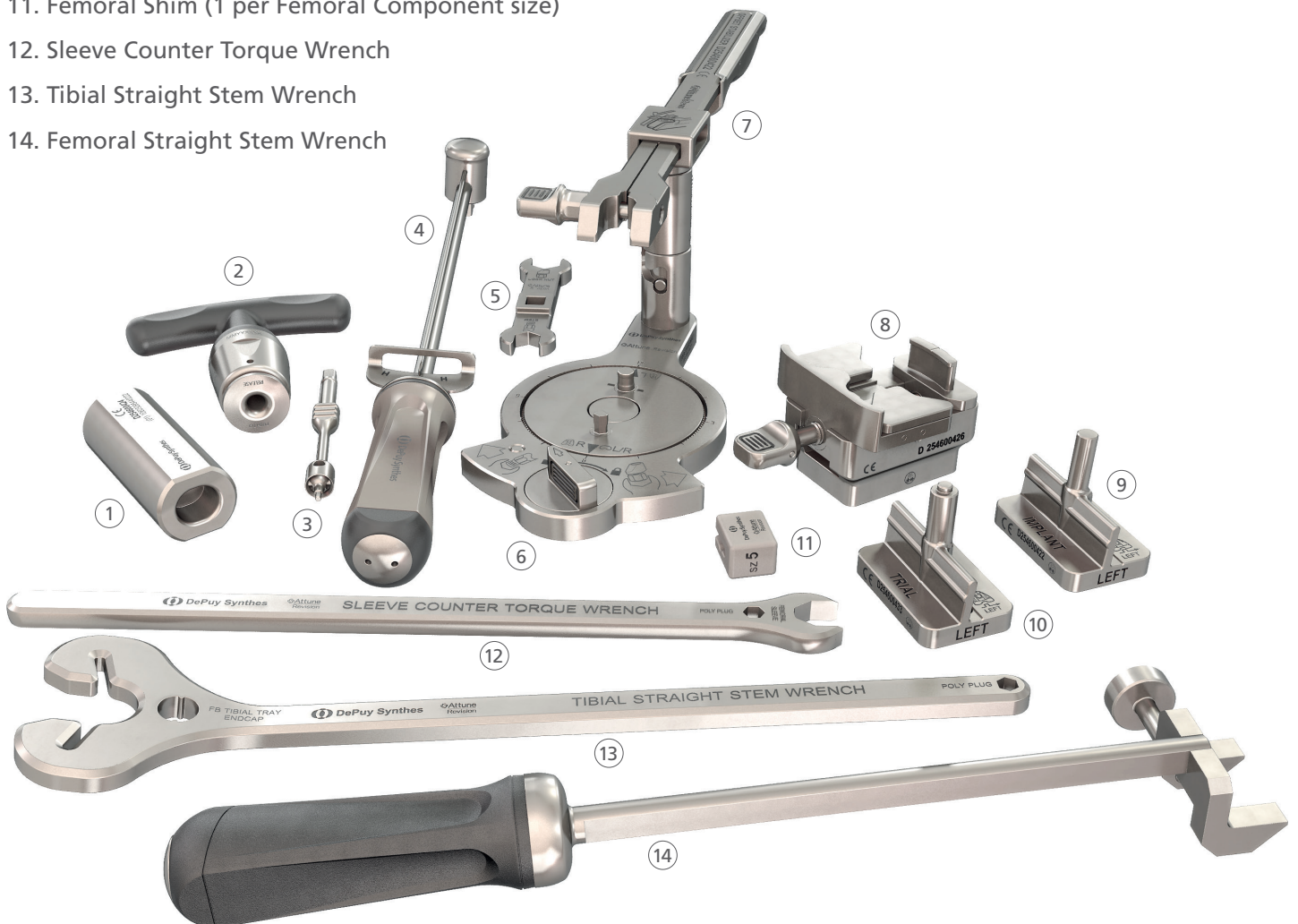

Augment Assembly



Straight Stem

For all Revision FB Tibial Bases or Femoral constructs with Straight Stems, assemble appropriate Augments **after** assembling any Stems.



Offset Stem

For all Revision FB Tibial Bases or Femoral constructs with Offset Stems, assemble appropriate Augments **prior** to adding the Offset Adaptor and Stem.



Femoral Sleeve and Stem

For Femoral constructs with a Sleeve, assemble appropriate Augments **prior** to assembling the Sleeve.

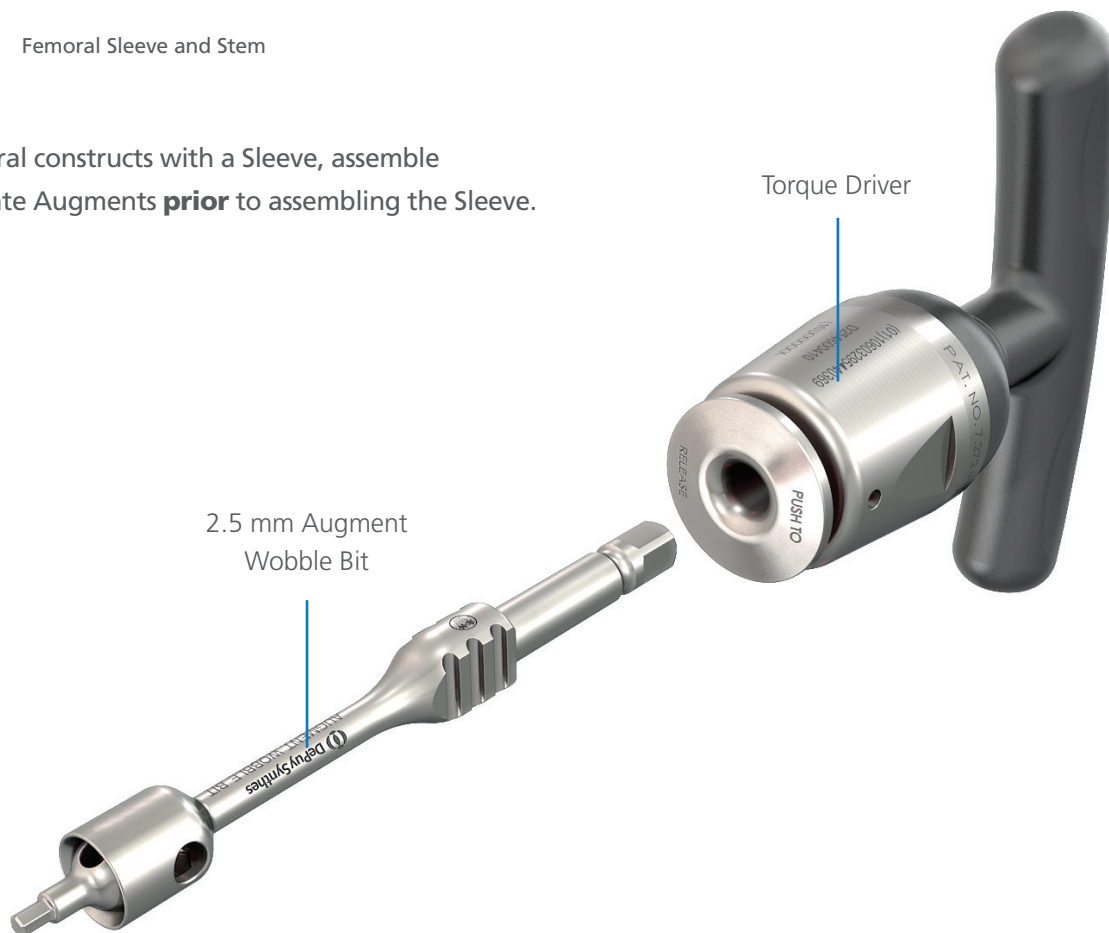

Tibial Augment Assembly

Tibial Augment Implants are shared across two Tibial Base sizes (1 - 2, 3 - 4, 5 - 6, 7 - 8, 9 - 10).

- The 5 mm Tibial Augments may be utilized on either the Medial or Lateral side of the Tibial Base.
- The 10 and 15 mm Tibial Augments are side specific and come in LM/RL or LL/RM offerings.

Using the 2.5 mm Wobble Bit and Augment Screws, affix the previously prepared for Tibial Augment(s) to the backside of the previously prepared for (size-specific) Revision Tibial Base Implant.



Ensure both Augment Screws are engaged with the Revision Tibial Base Implant prior to completing fixation. Attach the Torque Driver to the 2.5 mm Wobble Bit and continue to turn until a "click" is heard, to ensure adequate screw fixation.



INFORMATION

Using the 2.5 mm Wobble Bit by hand (to start each Augment Screw) prior to attaching the Torque Driver may assist by providing tactile feedback.

Femoral Augment Assembly

Using the Torque Driver with the 2.5 mm Wobble Bit, assemble the appropriate Posterior Augment(s) to the correct location(s) of the Revision Femoral Implant. 

Tighten the Femoral Augment Collet using the Torque Driver until a “click” is heard.

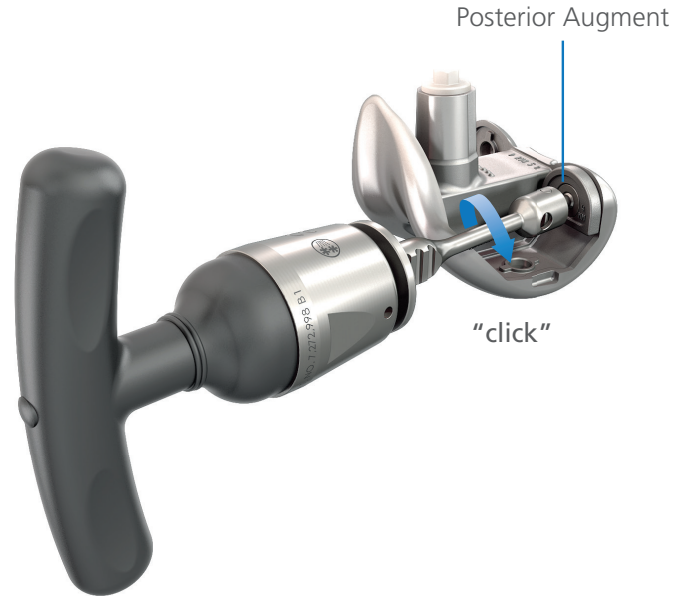

If a Posterior Augment is in place, the Distal Augment Implant will assemble into the distal location by rocking into location around the Posterior Augment. Otherwise, the Distal Augment will assemble into the distal location by loading from the proximal location.



CAUTION

Always assemble Posterior Augments to the Revision Femoral Component prior to any Distal Augments.

Revision FB Tibial Base and Straight Stem Implant Assembly



Straight Stem



INFORMATION

Note: The Base Protector should be retained on the Tibial Base during Assembly and Seating of the Tibial Base.

Remove the End Cap from the Revision Tibial Base Implant by utilizing the FB End Cap Remover in the Tibial Straight Stem Wrench and rotating the Tibial Straight Stem Wrench **counter clockwise** to unscrew the End Cap.

Thread the appropriate Stem Implant into the Revision FB Tibial Base until hand tight.

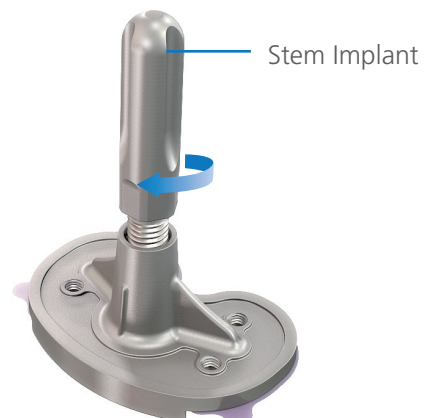
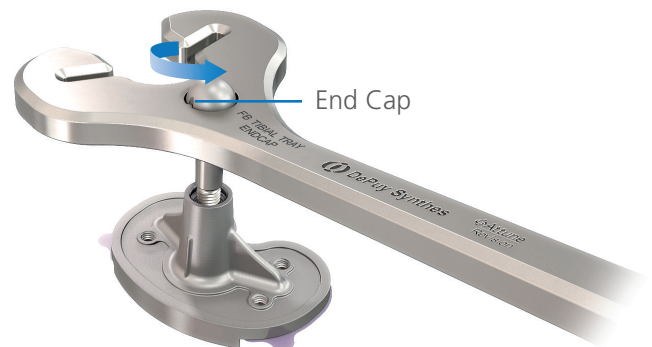
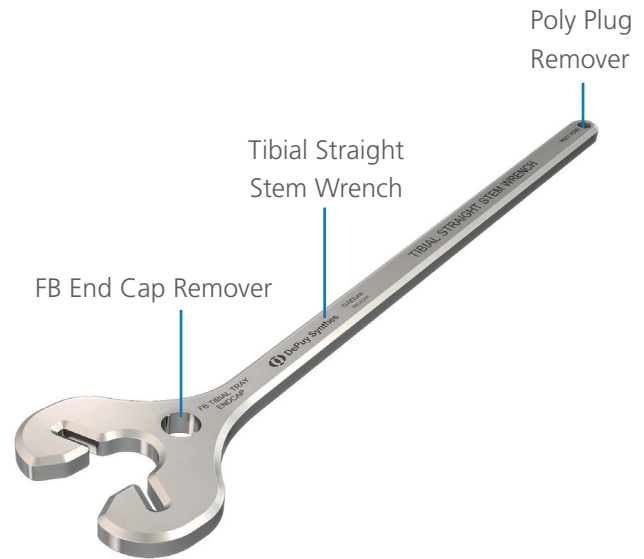

Revision FB Tibial Base and Straight Stem Implant Assembly



Straight Stem

Assemble the Assembly Wrench Adaptor to the Implant Assembly Wrench with the Stem Wrench facing outwards.

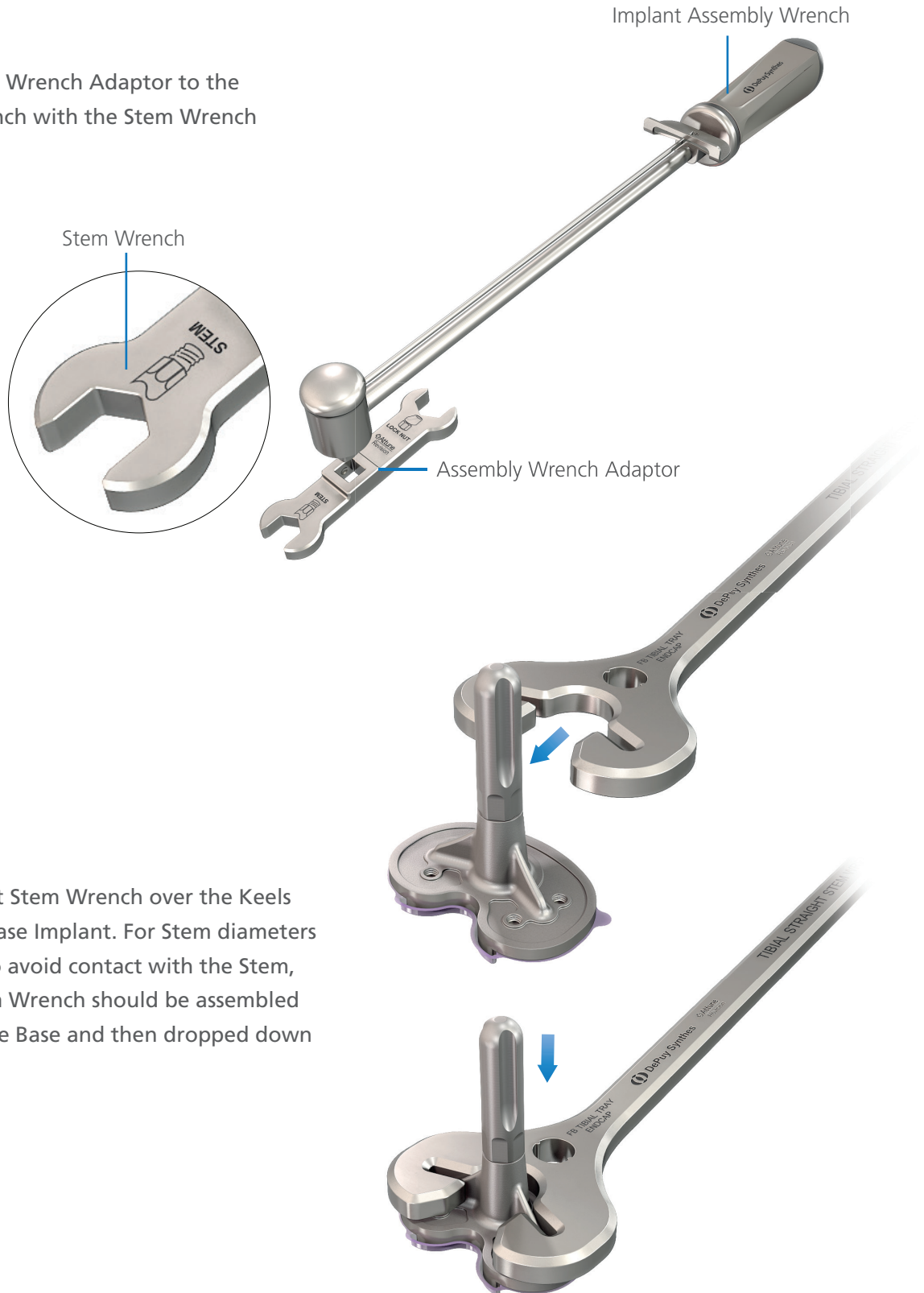

Place the Tibial Straight Stem Wrench over the Keels of the Revision Tibial Base Implant. For Stem diameters of 20 mm or greater, to avoid contact with the Stem, the Tibial Straight Stem Wrench should be assembled from the anterior of the Base and then dropped down onto the Keels.

Revision FB Tibial Base and Straight Stem Implant Assembly



Straight Stem

Hold the **Tibial Straight Stem Wrench** in the left hand, ensuring that the surface of the Tibial Straight Stem Wrench is flush on the Revision Tibial Base.

Hold the **Implant Assembly Wrench** in the right hand and position on the Hex of the Stem that has been threaded onto the Tibial Base, trying to achieve an angle of approximately 90 degrees between the Implant Assembly Wrench and Tibial Straight Stem Wrench. This will make it easier to apply the desired torque.

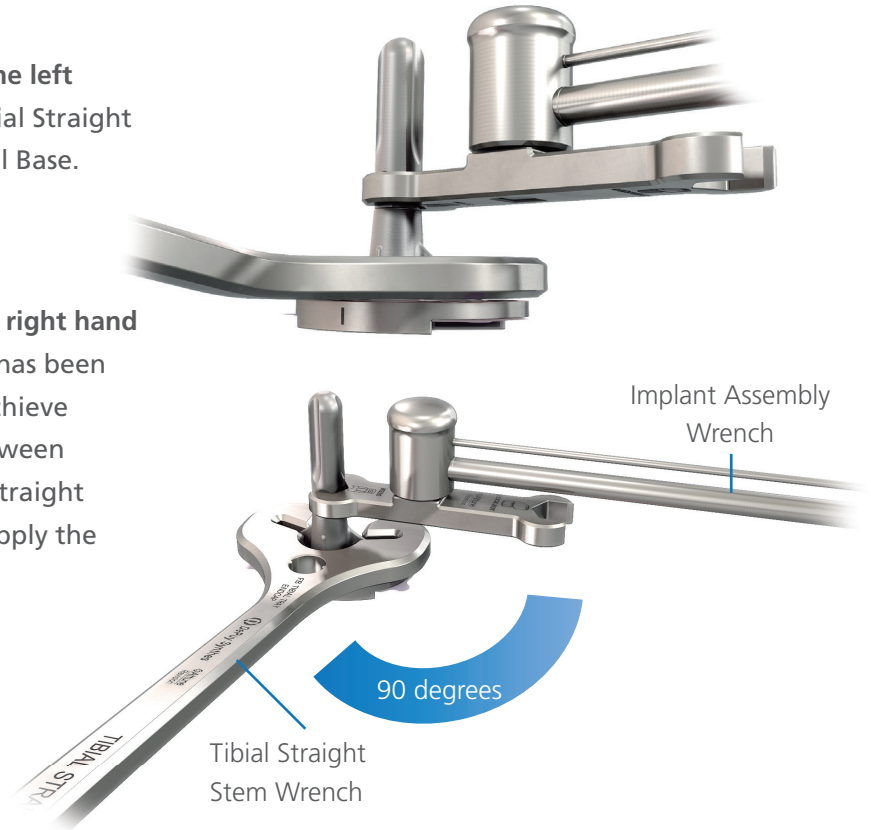

Gradually bring hands together to rotate the Implant Assembly Wrench until the marker is within the torque range marking.

Always assemble Tibial Augments after Straight Stems as described on page 171.

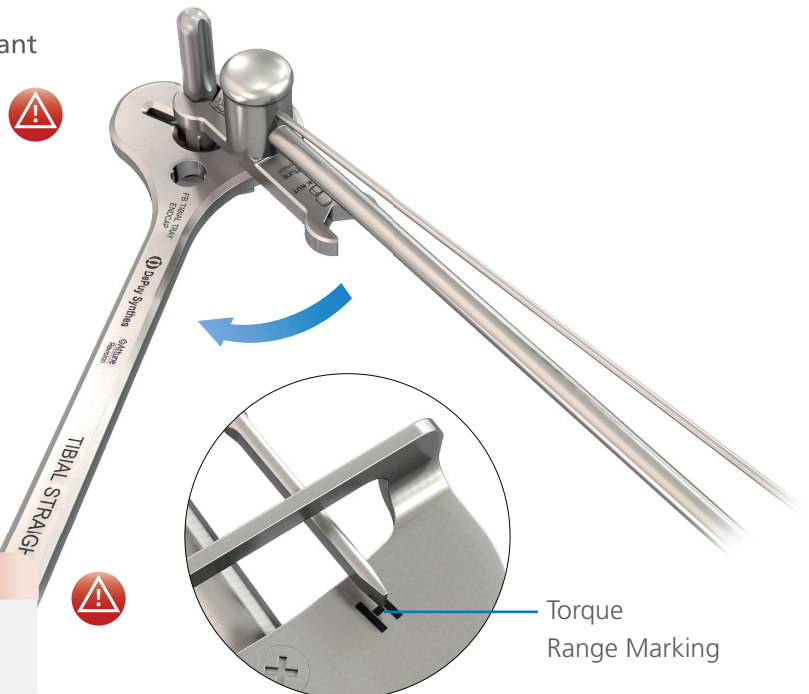

CAUTION

Do not apply so much torque that the marker fully passes the torque range marking.



Torque Range Marking

Revision Femoral Component and Straight Stem Implant Assembly



Straight Stem

Assemble Femoral Augments **after** Stems as described on **page 172**.

Assemble the Femoral Implant Post and Offset Stabilizer Arm to the Assembly Base.

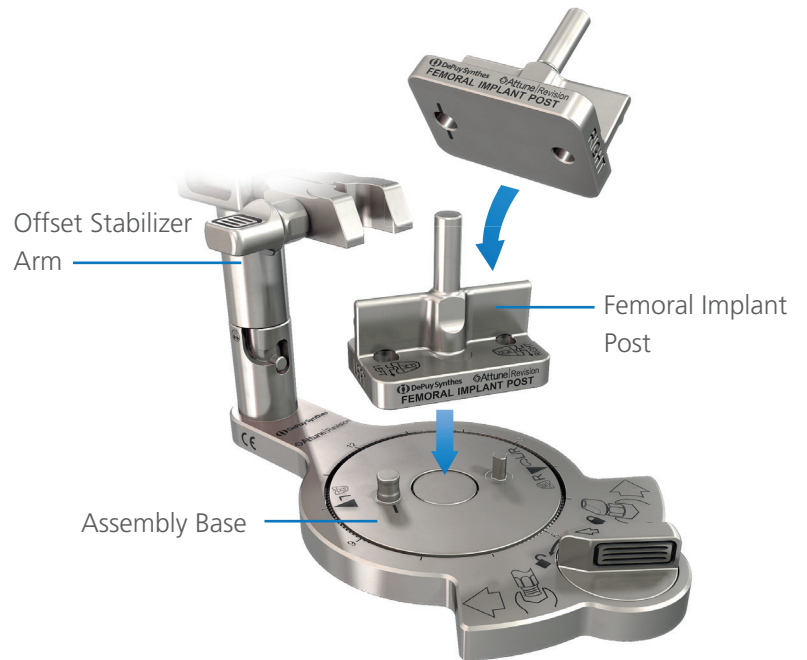

Slide the appropriate **sized** Femoral Shim onto the correct wing, Left or Right, of the Femoral Implant Post. For example, for a size 4 Femoral select the size 4 Femoral Shim.



Revision Femoral Component and Straight Stem Implant Assembly



Straight Stem

Remove the Poly Plug from the Revision Femoral Implant by utilizing the Poly Plug Remover in the Sleeve Counter Torque Wrench or Tibial Straight Stem Wrench and rotating the Poly Plug counter clockwise.



Place the Revision Femoral Implant on the Femoral Implant Post by engaging the post in the boss area.

Rotate the Femoral Implant on the Assembly Base until the "Left" or "Right" arrow for the respective Femoral Component is pointing to the "9 o'clock" position. This orientation helps with access to the Stem for tightening, without being obstructed by the Femoral Anterior Flange.



Revision Femoral Component and Straight Stem Implant Assembly



Straight Stem

Lock the orientation by rotating the Front Base Knob to the locked  position.

Front Base Knob



Thread the appropriate Stem on the Revision Femoral Implant until hand tight.



Implant Assembly Wrench

Assemble the Assembly Wrench Adaptor to the Implant Assembly Wrench with the Stem Wrench outward.

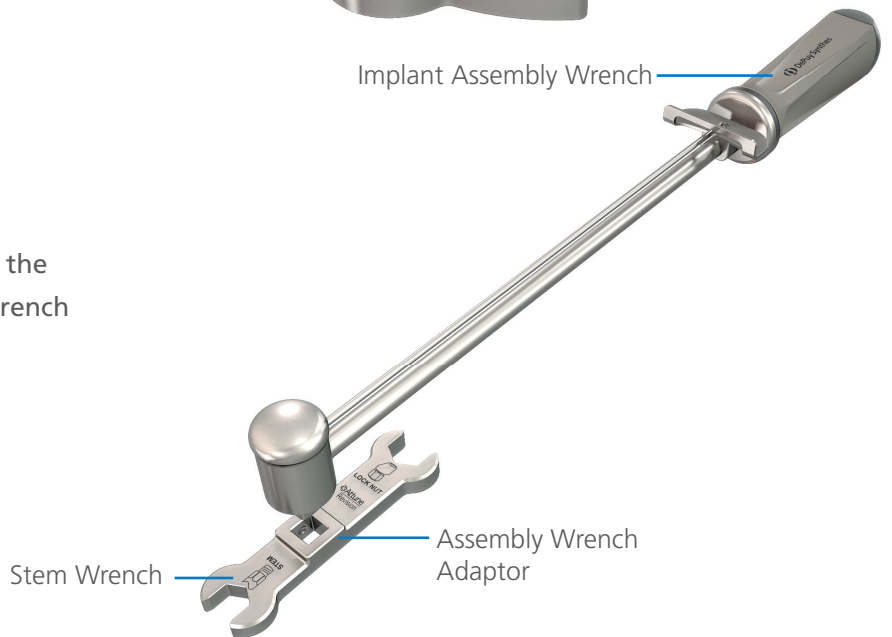

Stem Wrench

Assembly Wrench Adaptor

Revision Femoral Component and Straight Stem Implant Assembly



Straight Stem

Hold the **Offset Stabilizer Arm** in the left hand.

Hold the **Implant Assembly Wrench** in the right hand and position on the Hex of the Stem that has been threaded to the Femoral Implant, trying to achieve an angle of approximately 90 degrees between the Implant Assembly Wrench and Offset Stabilizer Arm. This will make it easier to apply the desired torque.

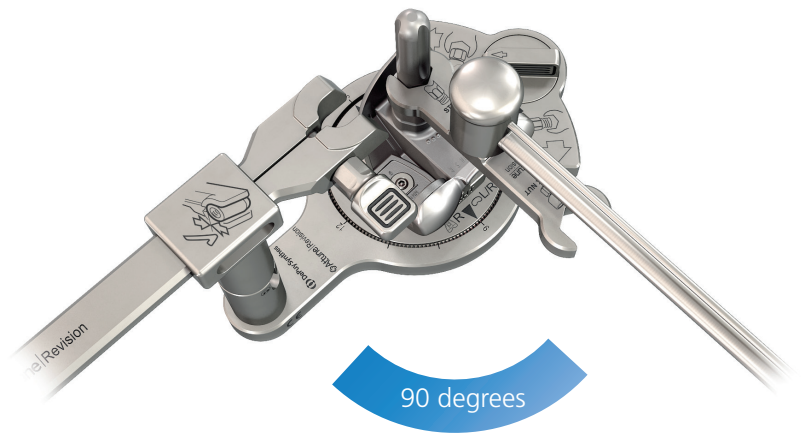

Gradually rotate the Implant Assembly Wrench towards the Offset Stabilizer Arm until the marker is within the torque range marking. ⚠️



⚠️ CAUTION

Do not apply so much torque that the marker fully passes the torque range marking.

Alternative Revision Femoral Component and Straight Stem Implant Assembly



Straight Stem

Assemble Femoral Augments **after** Stems as described on page 172.

Assemble the Assembly Wrench Adaptor to the Implant Assembly Wrench with the Stem Wrench facing outwards.

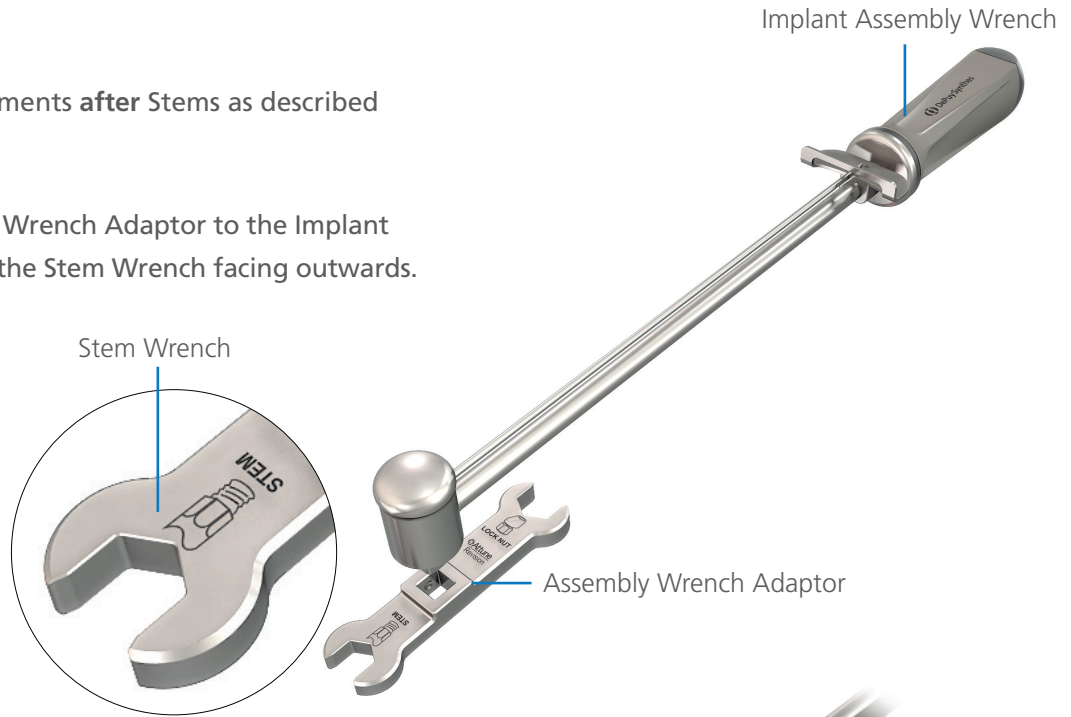

Place the ATTUNE Revision Femoral Straight Stem Wrench around the box of the Femoral Implant between the anterior flange and posterior condyles. The handle of the Femoral Straight Stem Wrench should run above the posterior condyles of the femoral implant.

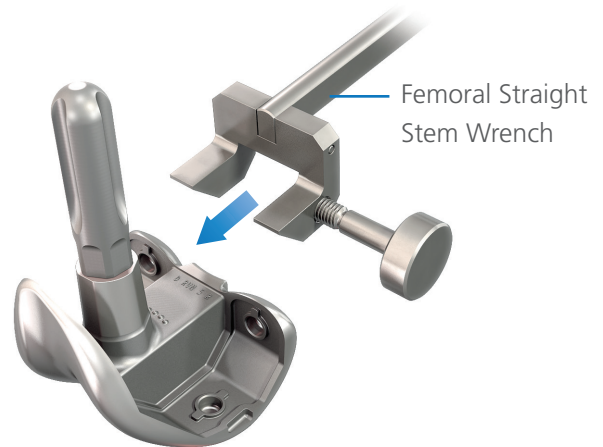

Tighten the thumb screw on the Stem Wrench until it is secured against the side of the box. Thread the desired Stem Implant on the Femoral Boss until hand tight.



Alternative Revision Femoral Component and Straight Stem Implant Assembly



Straight Stem

Hold the **Femoral Straight Stem Wrench** in the left hand.

Hold the **Implant Assembly Wrench** in the right hand and position on the Hex of the Stem that has been threaded to the Femoral Implant, trying to achieve an angle of approximately 90 degrees between the Implant Assembly Wrench and Femoral Straight Stem Wrench. This will make it easier to apply the desired torque.

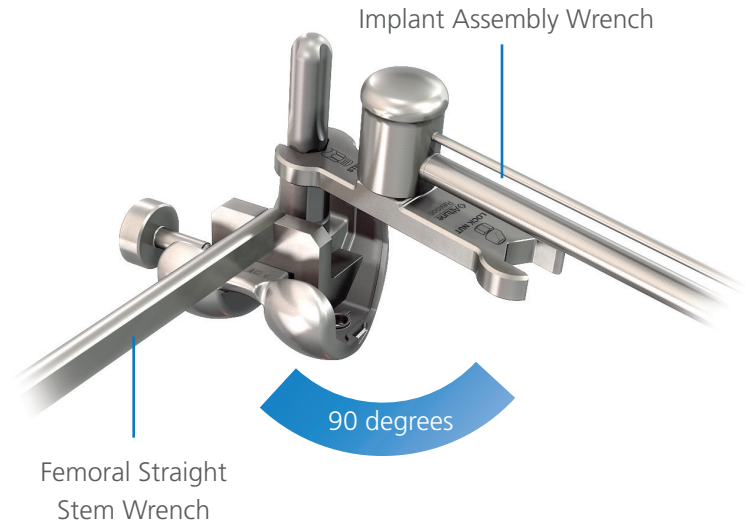

Gradually rotate the Implant Assembly Wrench towards the Femoral Straight Stem Wrench until the marker is within the torque range marking. 

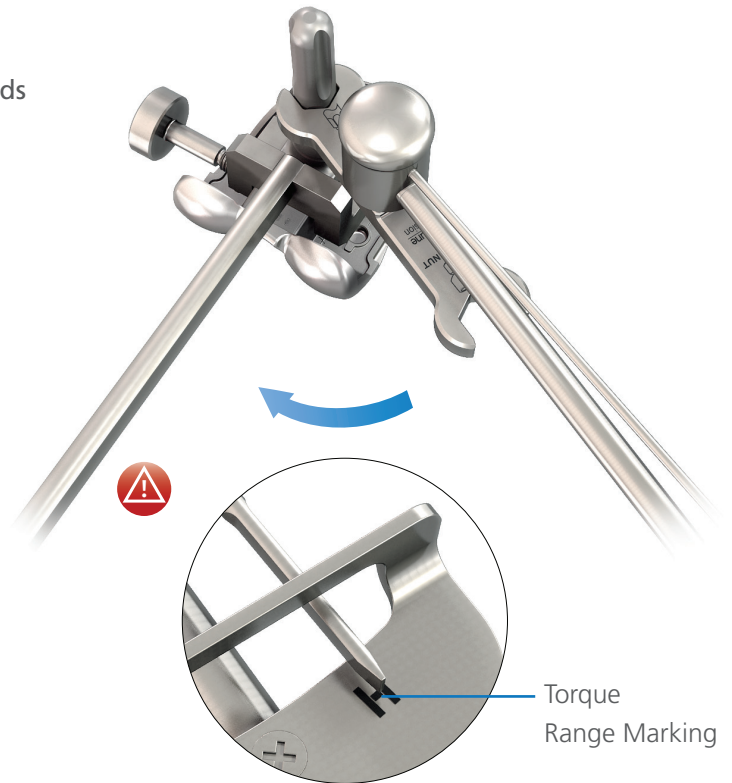

CAUTION

Do not apply so much torque that the marker fully passes the torque range marking.

Revision FB Tibial Base and Offset Stem Implant Assembly



Offset Stem



INFORMATION

Note: The Base Protector should be retained on the Tibial Base during assembly and seating of the Tibial Base.

The intent of the Offset Assembly Instruments is to have the offset orientation on the implant replicate the orientation of the offset in the Trial construct. It does this in two steps:

1. Use the Trial to set the orientation of the Assembly Jig.
2. Use the Assembly Jig to set the orientation of the Offset Adaptor on the Implant.

Assemble the Tibial Vice and Offset Stabilizer Arm to the Assembly Base.

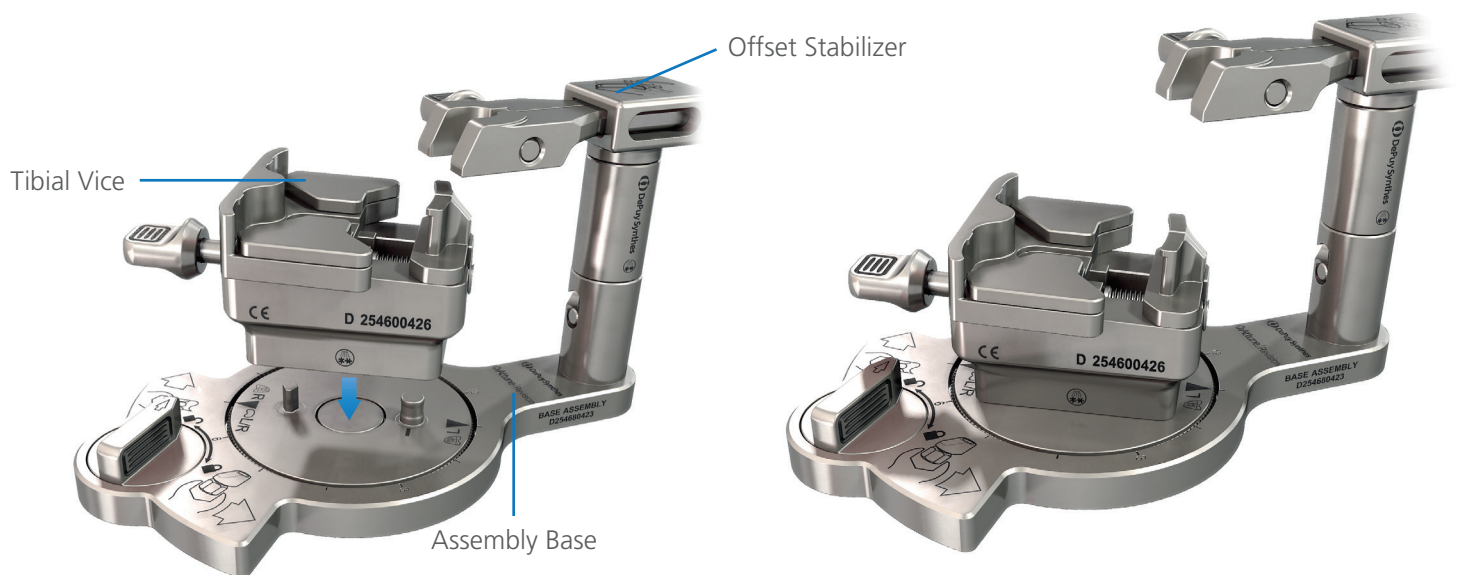

Revision FB Tibial Base and Offset Stem Implant Assembly



Offset Stem

Place the Trial Construct in the Tibial Vice and rotate the Tibial Vice Knob to tighten the Tibial Vice to the Tibial Trial Construct.



Orient the Tibial Offset Adaptor Trial to the Offset Stabilizer Arm and slide the Arm to contact the Trial. 

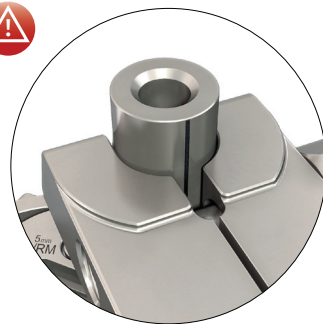
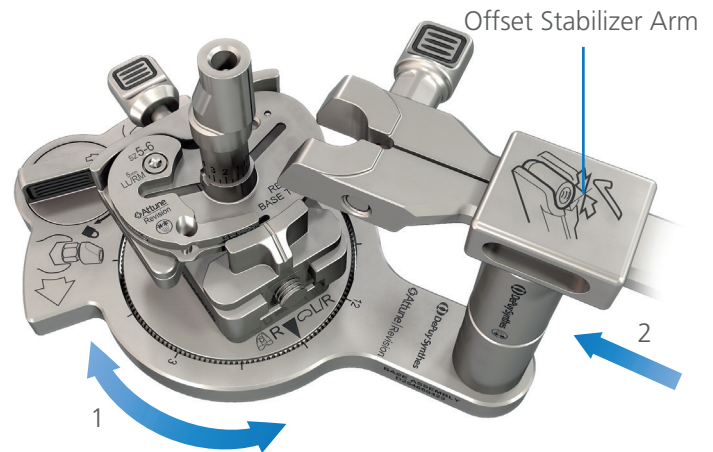

Aligned with the Alignment Window





CAUTION

In order to ensure that the Offset Adaptor is not inserted 180 degrees out of position, ensure that the black mark on the Tibial Offset Adaptor Trial is visibly positioned within the window of the Offset Stabilizer and that the Trial Construct offset number matches the number on the Base.

Revision FB Tibial Base and Offset Stem Implant Assembly



Offset Stem

Lock the Offset Stabilizer Arm using the Offset Locking Knob. Lock the orientation of the Tibial Vice by rotating the Front Base Knob to the locked  position. 

The Assembly Jig is now locked and replicates the Trial orientation.

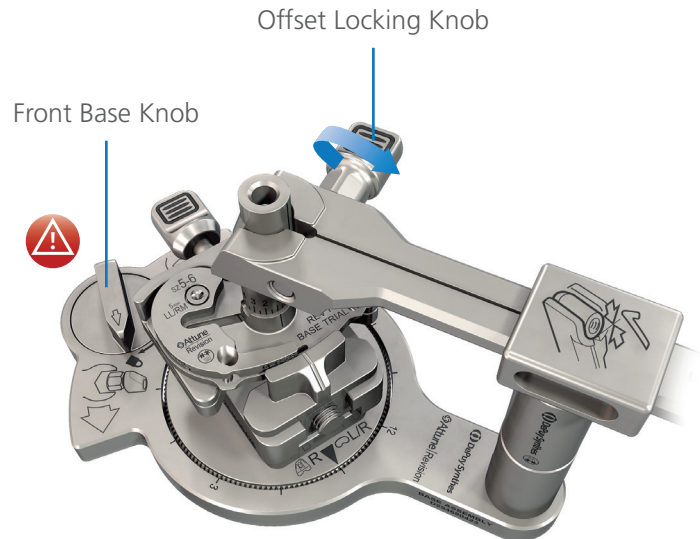

1. Loosen the Offset Locking Knob from the Tibial Offset Adaptor Trial.
2. Slide the Offset Stabilizer backwards.
3. Rotate the Tibial Vice Knob in the counter clockwise direction.
4. Remove the Tibial Trial.

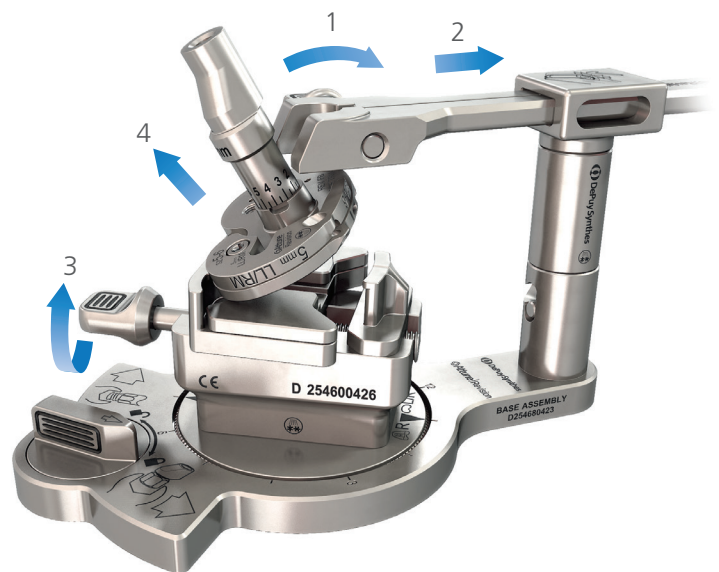

CAUTION

Do not unlock Assembly Base Knob, as this has set your orientation.

Revision FB Tibial Base and Offset Stem Implant Assembly



Offset Stem

Remove the End Cap from the Revision Fixed Bearing Tibial Base Implant by utilizing the FB End Cap Remover in the Tibial Straight Stem Wrench and rotating the Wrench counter clockwise to unscrew the End Cap.

If necessary, assemble Tibial Augments as described on [page 171](#) before assembling the Offset Stem Adaptor or Stem.

Place the Revision FB Tibial Base Implant on the Tibial Vice and rotate the Tibial Vice Knob clockwise to tighten the Tibial Vice on to the Revision FB Tibial Base Implant.

Ensure the Offset Locking Nut is in the correct starting position. If loose, tighten by rotating in the opposite direction of the arrow on the Offset Locking Nut until hand tight.



Revision FB Tibial Base and Offset Stem Implant Assembly



Offset Stem

Ensure the line on the Locking Nut is closest to the Revision FB Tibial Base.

Thread the Offset Adaptor clockwise on to the Revision FB Tibial Base Implant until fully seated.

Once fully seated, rotate the Offset Adaptor counter clockwise until it aligns with the Offset Stabilizer Arm.

Do not rotate the Offset Adaptor more than 360 degrees.



Slide the Offset Stabilizer Arm forward and tighten on to the Offset Adaptor by rotating the Offset Stabilizer Arm Locking Knob clockwise. Ensure that the black mark is aligned in the alignment window.



CAUTION

In order to ensure that the Offset Adaptor is not inserted 180 degrees out of position, ensure that the angled face of the Offset Adaptor is away from the Offset Stabilizer Arm.

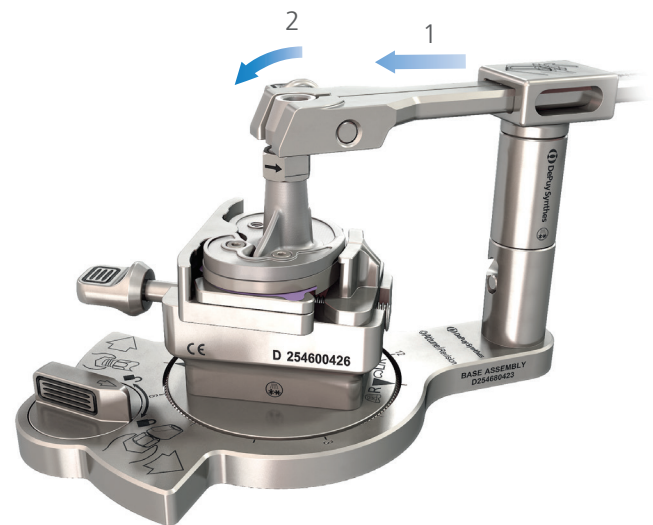
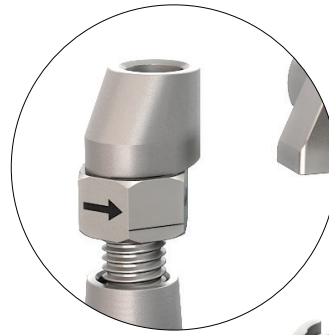

Revision FB Tibial Base and Offset Stem Implant Assembly



Offset Stem

The implant has now been aligned to the orientation of the Assembly Jig, which was set off of the Trial.

The next step is to tighten the Offset Locking Nut and Stem.

Rotate the Offset Locking Nut in the direction of the arrow on the Offset Adaptor Implant until hand tight.



Offset Locking Nut

Assemble the Assembly Wrench Adaptor to the Implant Assembly Wrench, with the Offset Locking Nut Wrench facing outward.

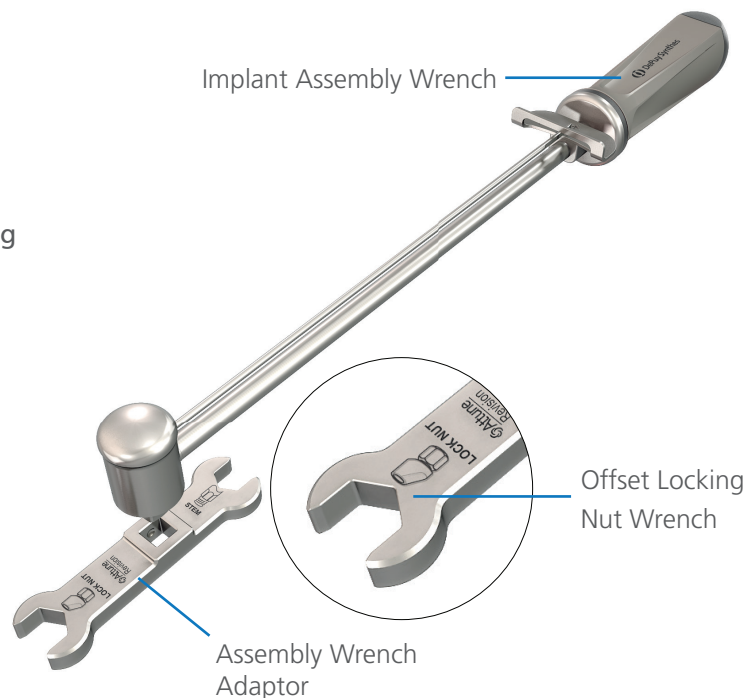

Implant Assembly Wrench

Offset Locking Nut Wrench

Assembly Wrench Adaptor

Revision FB Tibial Base and Offset Stem Implant Assembly



Offset Stem

Holding the **Implant Assembly Wrench** with **left hand**, assemble it to the Offset Locking Nut so that the angle between the Implant Wrench Assembly and the Offset Stabilizer Arm is approximately 90 degrees. This will make it easier to apply the desired torque.

Hold the **Offset Stabilizer** in the **right hand** and rotate the Implant Assembly Wrench counter clockwise, gradually bringing hands together to tighten the Locking Nut until the marker is within the torque range marking. 

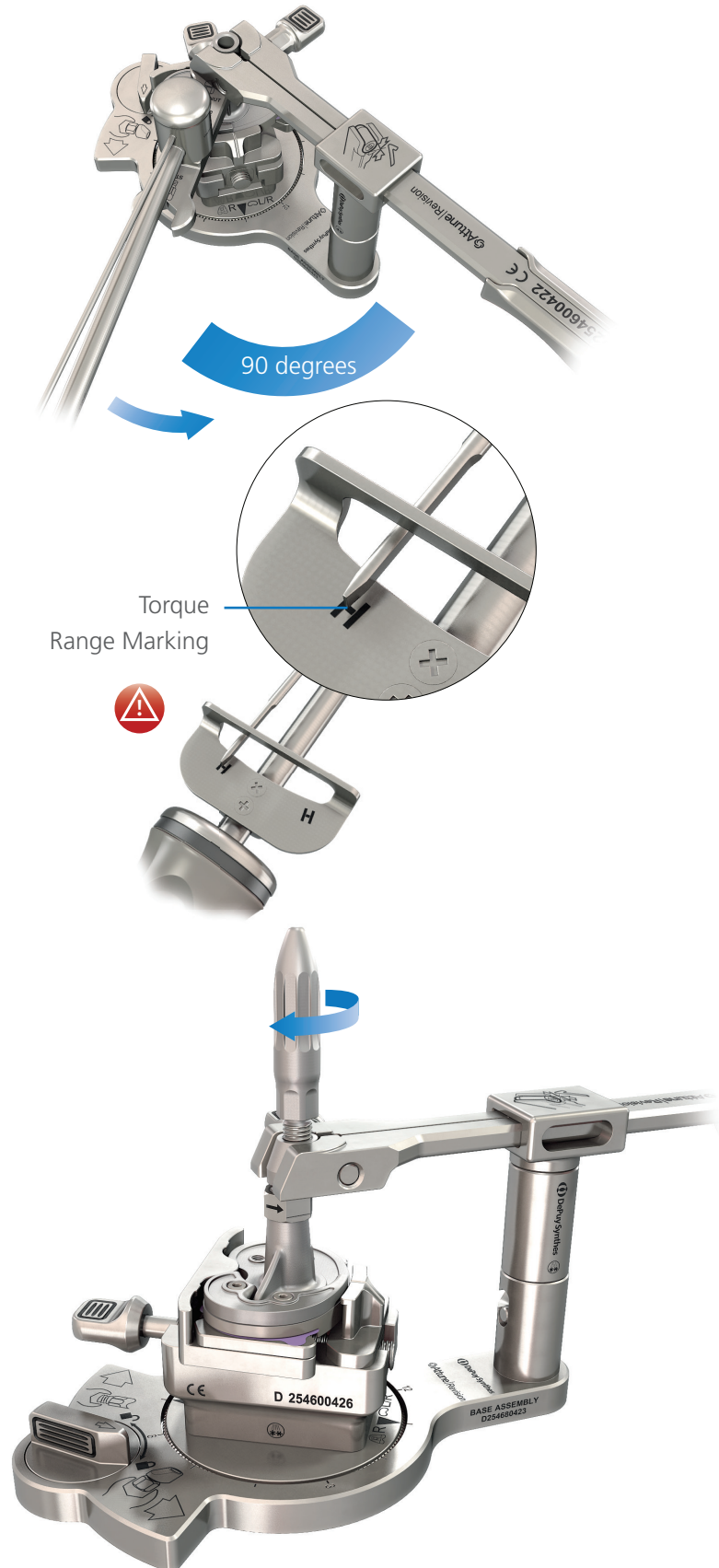

Thread the appropriate Stem on to the Offset Adaptor by rotating the Stem clockwise on to the Offset Adaptor until hand tight.



CAUTION

Do not apply so much torque that the marker fully passes the torque range marking.

Revision FB Tibial Base and Offset Stem Implant Assembly



Offset Stem

Assemble the Assembly Wrench Adaptor to the Implant Assembly Wrench with the Stem Wrench facing outward.

Hold the **Implant Assembly Wrench** in the right hand and position on the Hex of the Stem that has been threaded on to the Revision FB Tibial Base Implant to create an angle of approximately 90 degrees with the Offset Stabilizer Arm.

Grasp the **Offset Stabilizer** with left hand and gradually bring hands together to rotate the Implant Assembly Wrench clockwise to tighten the Stem until the marker is within the torque range marking. 

Loosen the Front Knob first to release any tension in the system. Then loosen the Locking Knob of the Offset Stabilizer Arm and slide back. Finally, loosen the Tibial Vice Knob to remove the final Implant Construct.

Confirm visually that the implant offset is in the correct orientation relative to the Trial.

Implant Assembly Wrench

Stem Wrench

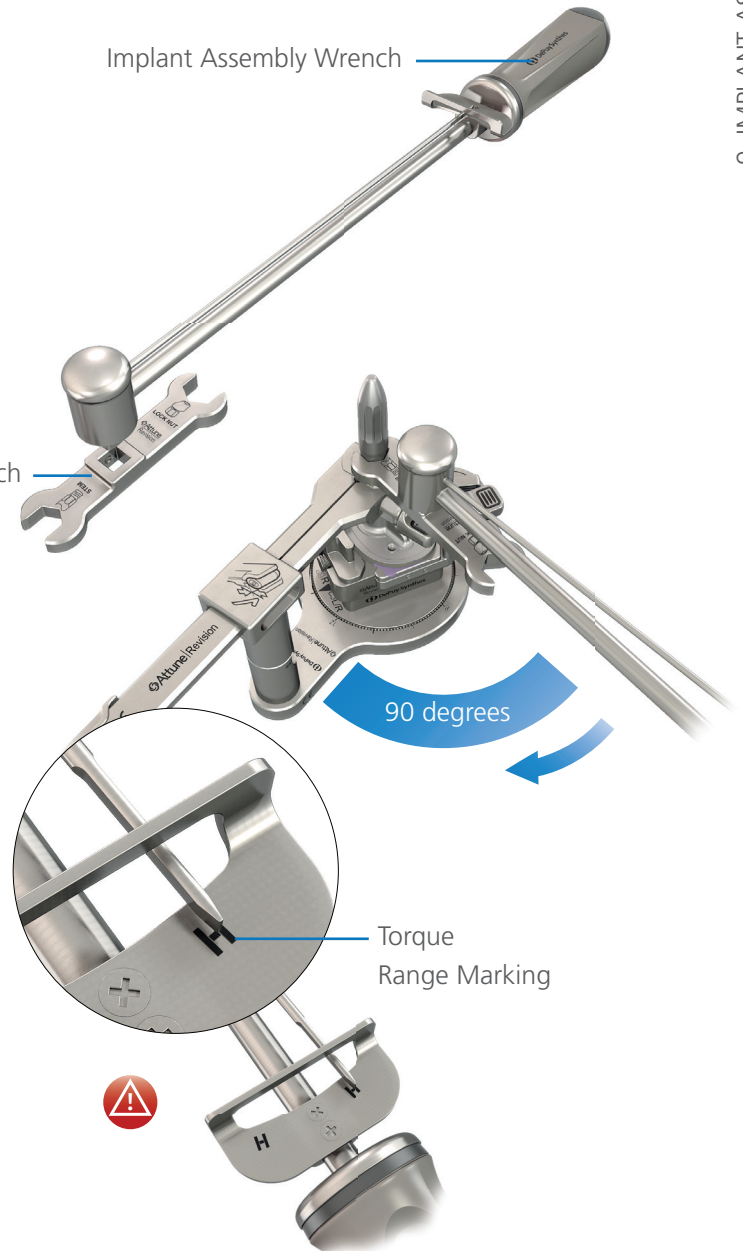

90 degrees

Torque Range Marking

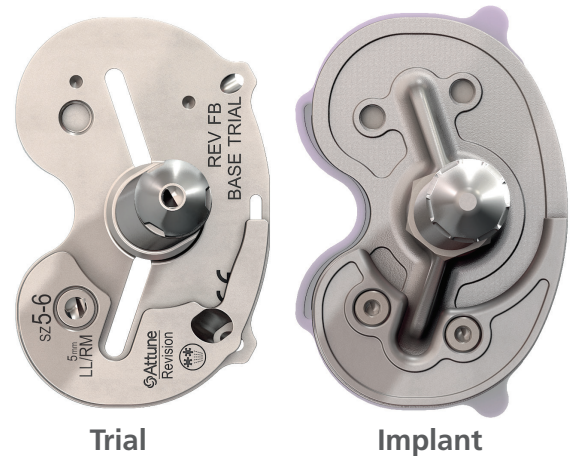

Trial

Implant



CAUTION

Do not apply so much torque that the marker fully passes the torque range marking.

Revision Femoral Component and Offset Stem Implant Assembly



Offset Stem

Assemble Femoral Augments **before** Stems as described on **page 172**.

The intent of the Offset Assembly Instruments is to have the offset orientation on the Implant replicate the orientation of the offset in the Trial Construct. It does this in two steps:

1. Use the Trial to set the orientation of the Assembly Jig.
2. Use the Assembly Jig to set the orientation of the Offset Adaptor on the Implant.

Assemble the Femoral Trial Post and Offset Stabilizer Arm to the Assembly Base.

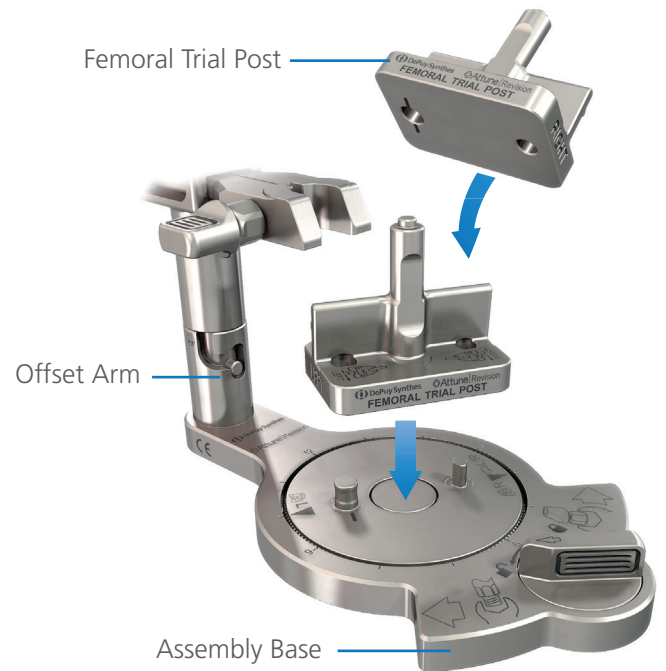

Slide the appropriate sized Femoral Shim onto the correct wing, Left or Right, of the Femoral Trial Post.

For example, for a size 4 Femoral select the 4 Femoral Shim.

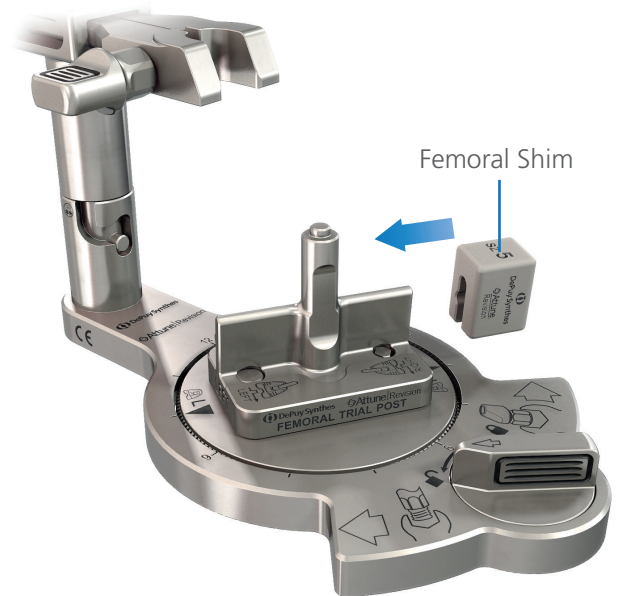

Revision Femoral Component and Offset Stem Implant Assembly



Offset Stem

Place the final Femoral Offset Trial Construct on the Femoral Trial Post by engaging the Femoral Post in the Trial Boss.

Femoral Offset Trial Construct

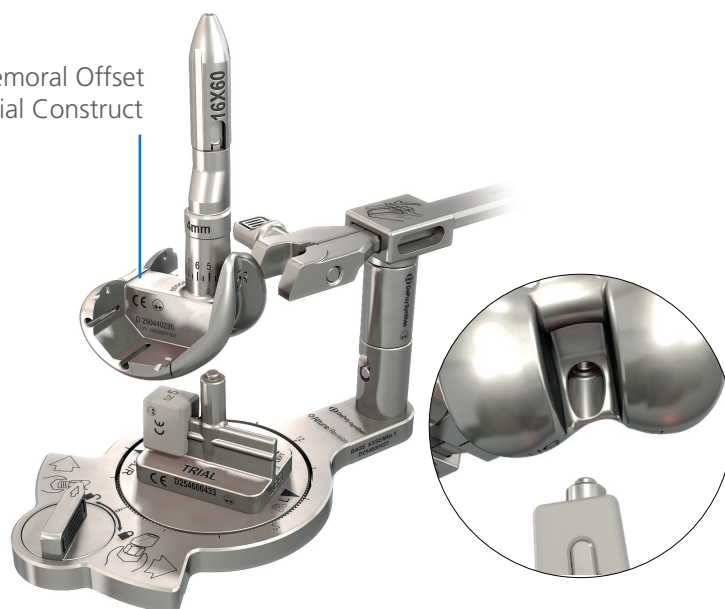

Orient the Femoral Offset Adaptor Trial to the Offset Stabilizer Arm and slide the Arm to contact the Trial.

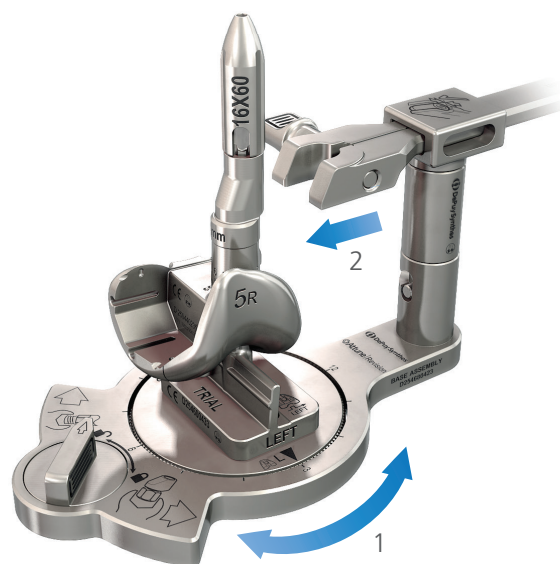

Aligned with the Alignment Window





CAUTION

In order to ensure that the Offset Adaptor is not inserted 180 degrees out of position, ensure that the black mark on the Femoral Offset Adaptor Trial is visibly positioned within the window of the Offset Stabilizer and that the Trial Construct offset number matches the number on the Base corresponding to the "left or right" mark as appropriate.

Revision Femoral Component and Offset Stem Implant Assembly



Offset Stem

Lock the Offset Stabilizer Arm using the Offset Locking Knob. Lock the orientation of the Femoral Offset Adaptor by rotating the Front Base Knob to the locked  position. 

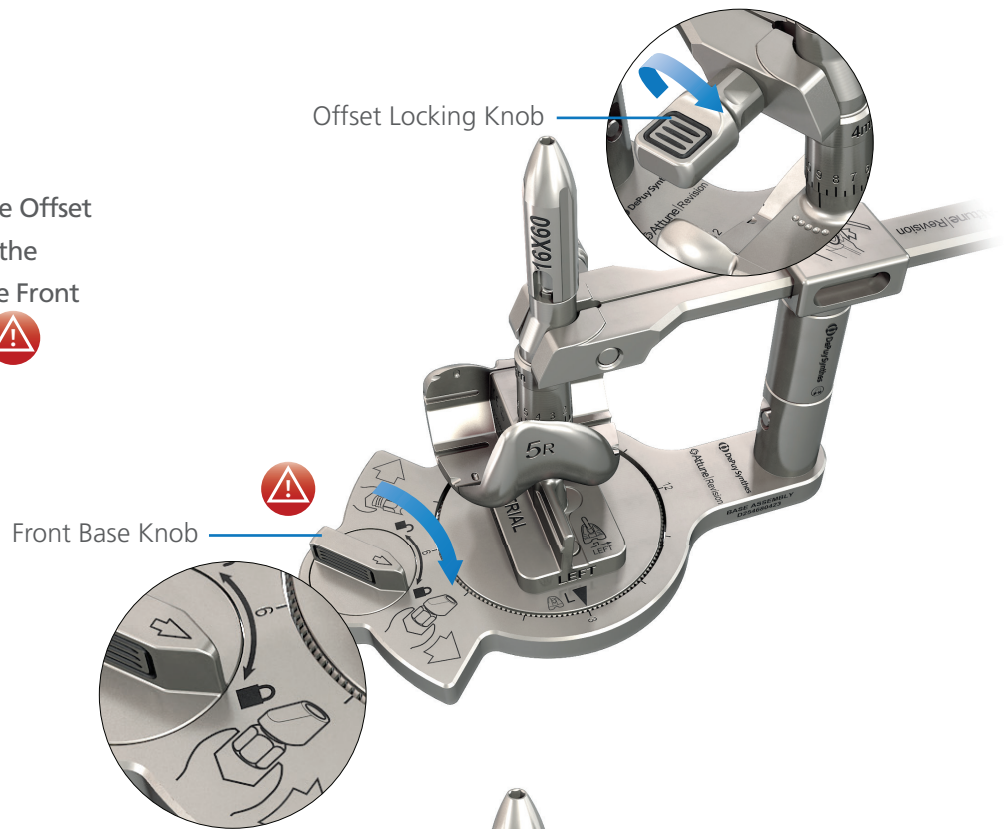

The Assembly Jig is now locked and replicates the Trial orientation.

1. Loosen the Offset Stabilizer Arm from the Femoral Offset Adaptor Trial.
2. Slide the Offset Stabilizer Arm backwards.
3. Lift the Femoral Trial Assembly out of the Assembly Base.
4. Lift the Femoral Trial Post out of the Assembly Base.



CAUTION

Do not unlock Assembly Base Knob, as this has set your orientation.

Revision Femoral Component and Offset Stem Implant Assembly



Offset Stem

Assemble the Femoral Implant Post to the Assembly Base and transfer the Shim from the Femoral Trial Post to the Femoral Implant Post.

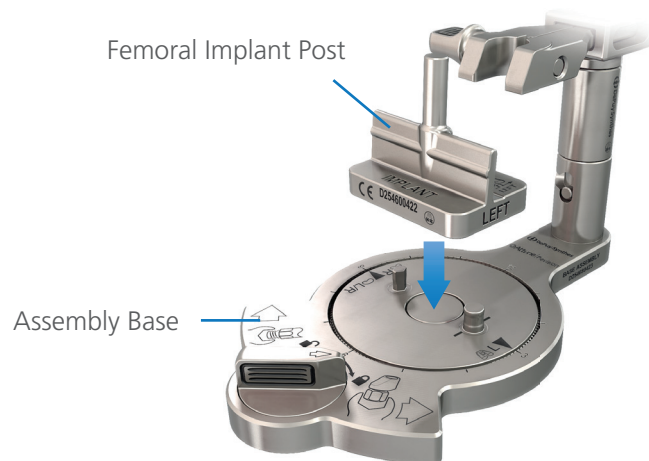

Remove the Poly Plug from the Revision Femoral Implant by utilizing the Poly Plug Remover in the Sleeve Counter Torque Wrench or Tibial Straight Stem Wrench and rotating the Poly Plug counter clockwise.

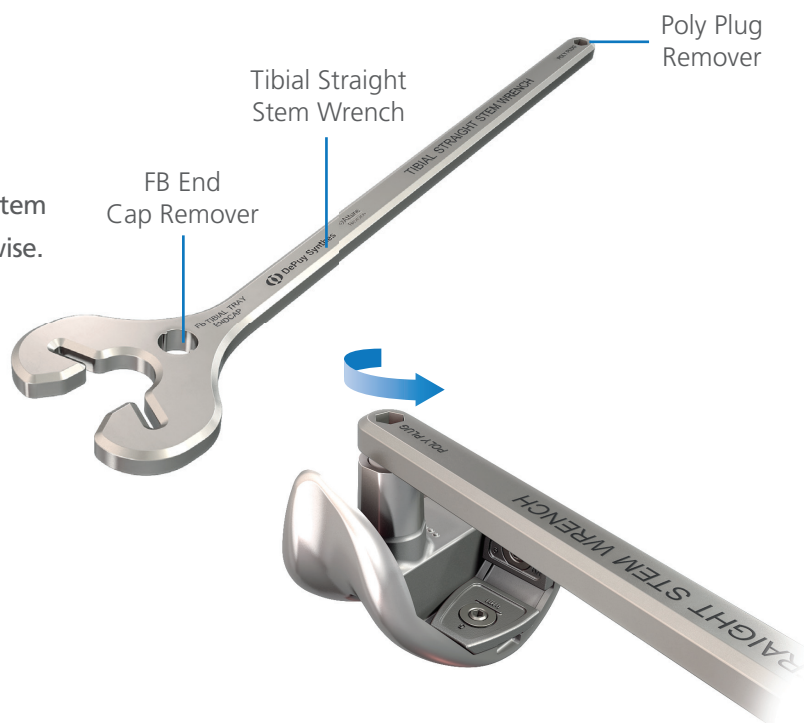

Revision Femoral Component and Offset Stem Implant Assembly



Offset Stem

Place the Revision Femoral Implant on the Femoral Implant Post by engaging the post in the boss area of the Implant.



Ensure the Offset Locking Nut is in the correct starting position by rotating in the opposite direction of the arrow on the Offset Adaptor until hand tight.

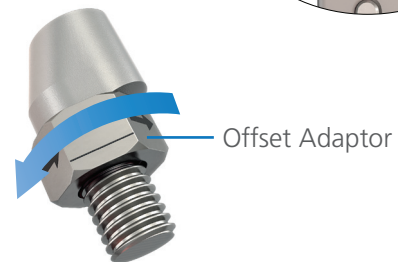

Ensure the line on the Locking Nut is closest to the Femoral Component.



Thread the Offset Adaptor clockwise on to the Revision Femoral Implant until the Offset Adaptor is fully seated.



Revision Femoral Component and Offset Stem Implant Assembly



Offset Stem

Once fully seated, rotate the Offset Adaptor counter clockwise until it aligns with the Offset Stabilizer Arm. 

Slide the Offset Stabilizer Arm forward and tighten on to the Offset Adaptor by rotating the Offset Stabilizer Arm Lock Knob clockwise. Ensure the black mark is aligned in the alignment window.

The implant has now been aligned to the orientation of the Assembly Jig, which was set off of the Trial.

The next step is to tighten the Offset Locking Nut and Stem.

Rotate the Offset Locking Nut in the direction of the arrow on the Offset Adaptor Implant until hand tight.



CAUTION

In order to ensure that the Offset Adaptor is not inserted 180 degrees out of position, ensure that angled face of the Offset Adaptor is away from the Offset Stabilizer Arm.



CAUTION

Do not rotate the Offset Adaptor more than 360 degrees.

Revision Femoral Component and Offset Stem Implant Assembly



Offset Stem

Assemble the Assembly Wrench Adaptor to the Implant Assembly Wrench, with the Offset Locking Nut Wrench facing outward.

Holding the **Implant Assembly Wrench** with left hand, assemble it to the Offset Locking Nut so that the angle between the Implant Assembly Wrench and the Offset Stabilizer Arm is approximately 90 degrees. This will make it easier to apply the desired torque.

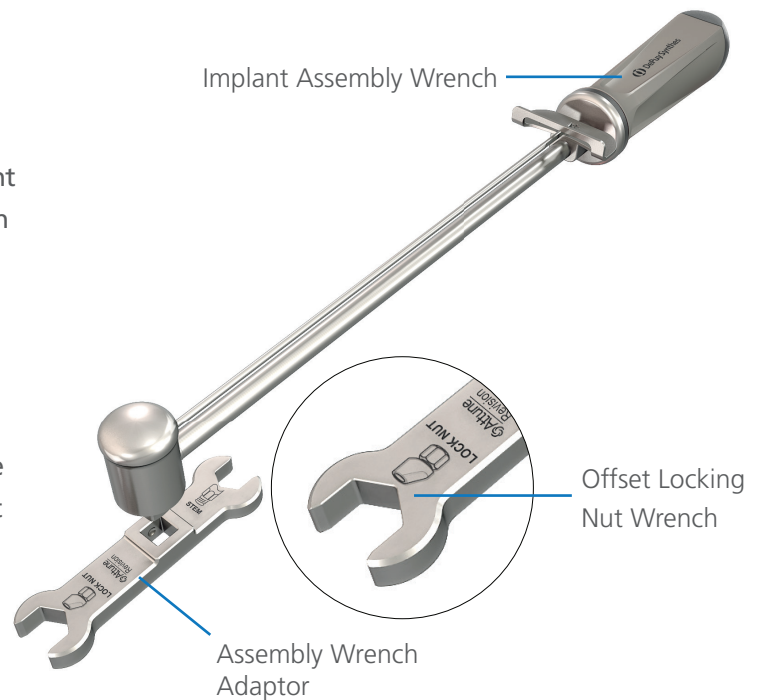

Implant Assembly Wrench

Offset Locking Nut Wrench

Assembly Wrench Adaptor

Hold the **Offset Stabilizer** in the right hand and rotate the Implant Assembly Wrench counter clockwise, gradually bringing hands together to tighten the Locking Nut until the marker is within the torque range marking. ⚠️

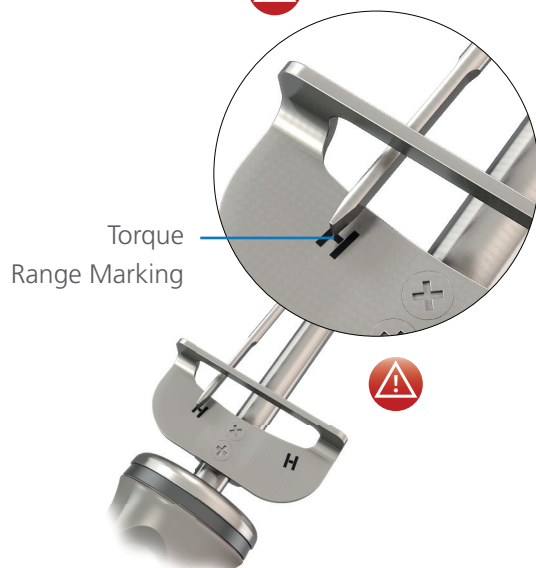

Torque Range Marking

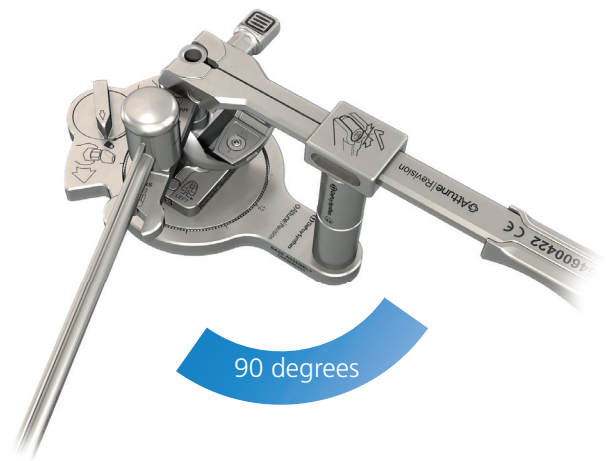

90 degrees



CAUTION

Do not apply so much torque that the marker fully passes the torque range marking.

Revision Femoral Component and Offset Stem Implant Assembly



Offset Stem

Thread the appropriate Stem on to the Offset Adaptor by rotating the Stem clockwise on to the Offset Adaptor until hand tight.



Assemble the Assembly Wrench Adaptor to the Implant Assembly Wrench, with the Stem Wrench facing outward.

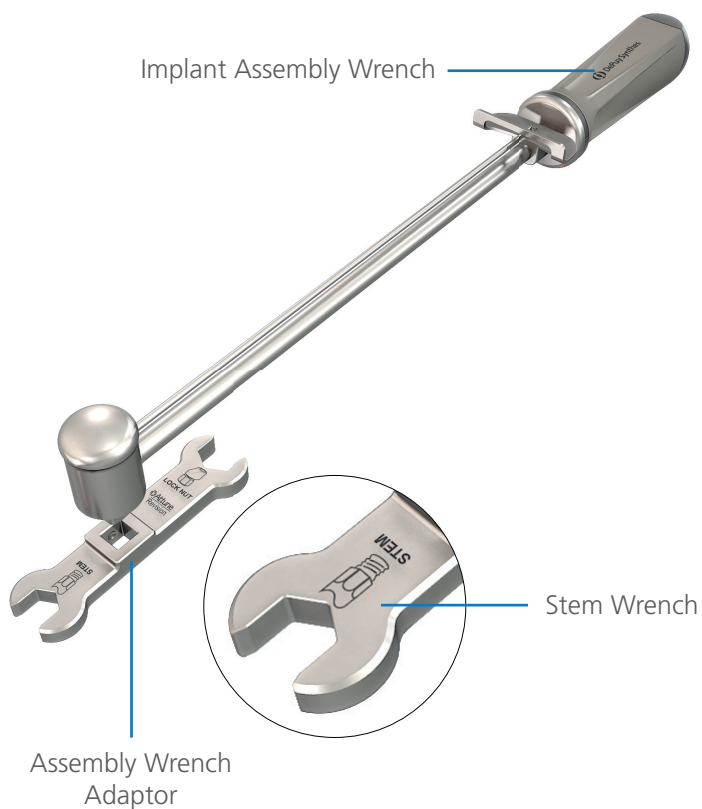

Revision Femoral Component and Offset Stem Implant Assembly



Offset Stem

Hold the **Implant Assembly Wrench** in the right hand and position on the Hex of the Stem that has been threaded on to the Revision Femoral Implant to create an angle of approximately 90 degrees with the Offset Stabilizer Arm.

Grasp the **Offset Stabilizer Arm** with left hand and gradually bring hands together to rotate the Implant Assembly Wrench clockwise to tighten the Stem until the marker is within the torque range marking. ⚠️

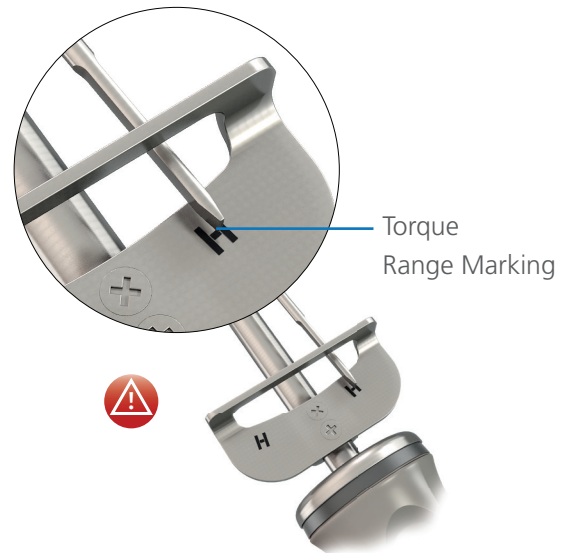
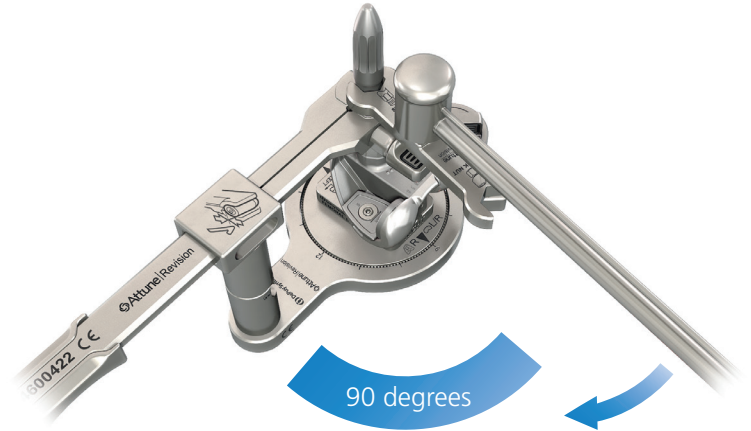

Loosen the front knob first to release any tension in the system. Then loosen the Locking Knob of the Offset Stabilizer Arm and slide back to remove the final Implant Construct.

Confirm visually that the implant offset is in the correct orientation relative to the Trial.



Trial

Implant



CAUTION

Do not apply so much torque that the marker fully passes the torque range marking.

Revision Femoral Component and Femoral Sleeve Assembly



Femoral Sleeve and Stem

Assemble Augments to the Femoral Implant **before** Stems or Sleeves as described on **page 172**.

Slide the appropriate sized Femoral Shim onto the correct wing, Left or Right, of the Femoral Implant Post.

For example, for a size 4 Femoral select the 4 Femoral Shim.

The Poly Plug should be retained in the Revision Femoral Component when being assembled with a Femoral Sleeve.

Place the Revision Femoral Implant on the Femoral Implant Post.

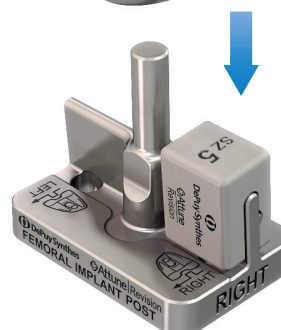
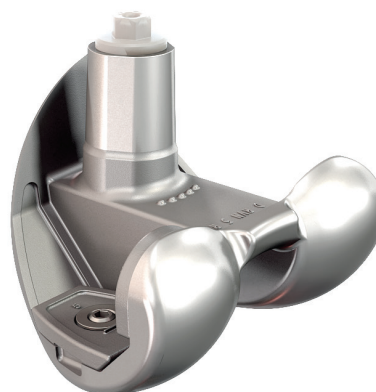
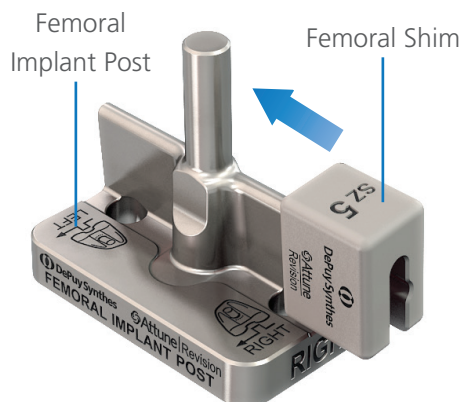

Revision Femoral Component and Femoral Sleeve Assembly



Femoral Sleeve and Stem

Using the retained Femoral Trial Assembly and Sleeve orientation features as a reference, position the Femoral Sleeve Implant in the correct orientation on the Revision Femoral Implant.

Remove the Poly Plug from the Femoral Sleeve by utilizing the Poly Plug Remover in the Sleeve Counter Torque Wrench and rotating the Poly Plug counter clockwise.

Once the desired rotation has been set, gently press on the Femoral Sleeve to establish an initial taper engagement.

Fully seat and lock the Sleeve Taper on the Revision Femoral Implant, using the Femoral End of the ATTUNE Revision Sleeve Impactor and a mallet.

i INFORMATION

To aid in visualization, the Femoral Trial and Broach Assembly may be placed on the Femoral Trial Post.

Trial Orientation Features

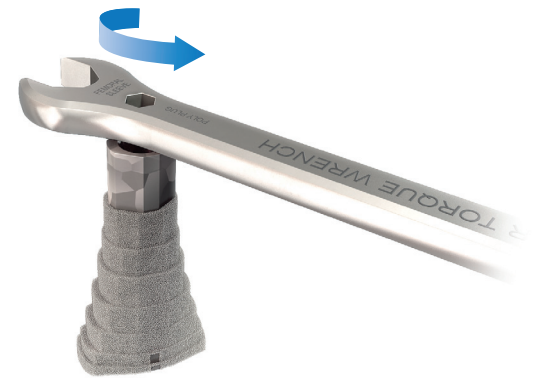
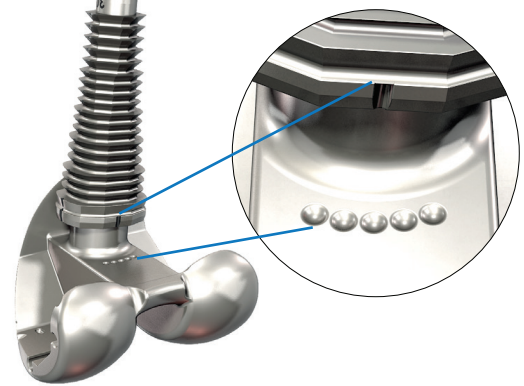

Implant Orientation Features

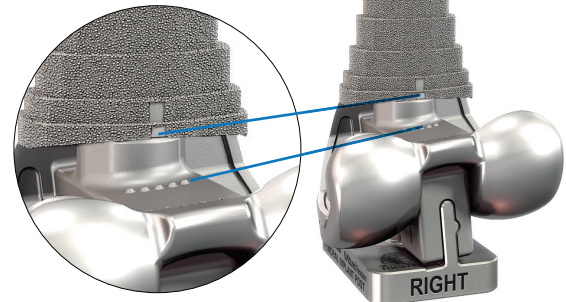

Femoral End



Femoral End



Revision Femoral Component and Femoral Sleeve Assembly



Femoral Sleeve and Stem

Thread the appropriate Stem on to the Femoral Sleeve until hand tight.



Assemble the Assembly Wrench Adaptor to the Implant Assembly Wrench with the Stem Wrench facing outward.

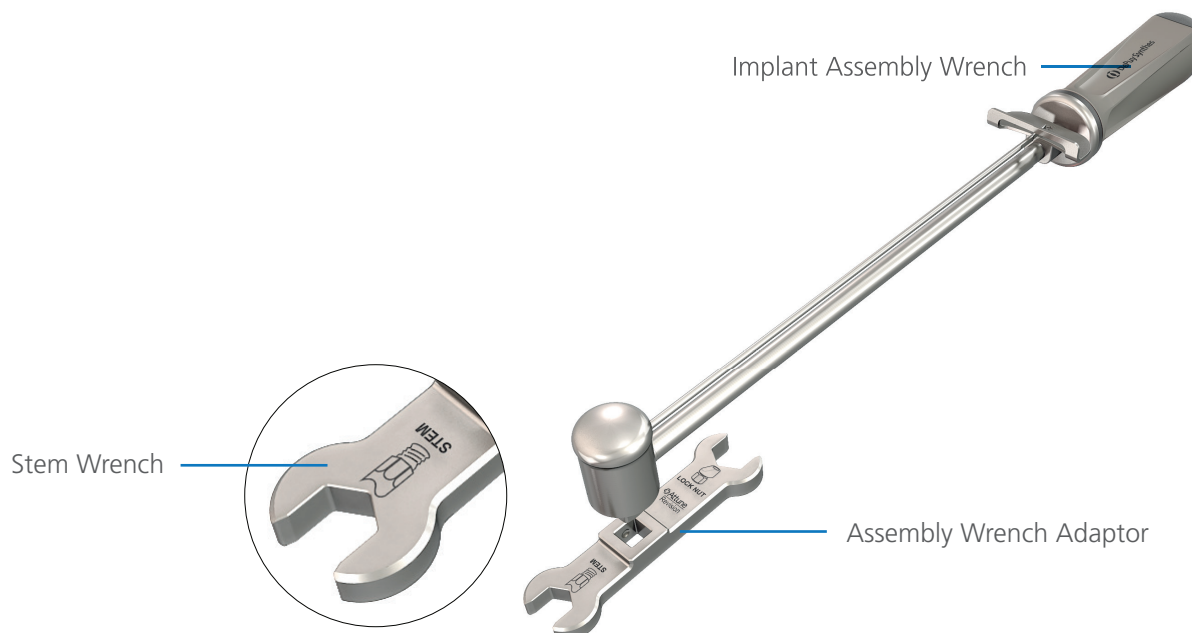

Revision Femoral Component and Femoral Sleeve Assembly



Femoral Sleeve and Stem

Hold the **Implant Assembly Wrench** in the **right hand** and position on the Hex of the Stem that has been threaded on to the Revision Femoral Implant.

Hold the **Sleeve Counter Torque Wrench** in the **left hand** and position on the Femoral Sleeve to create an angle of approximately 90 degrees with the Implant Assembly Wrench. This will make it easier to apply the desired torque.

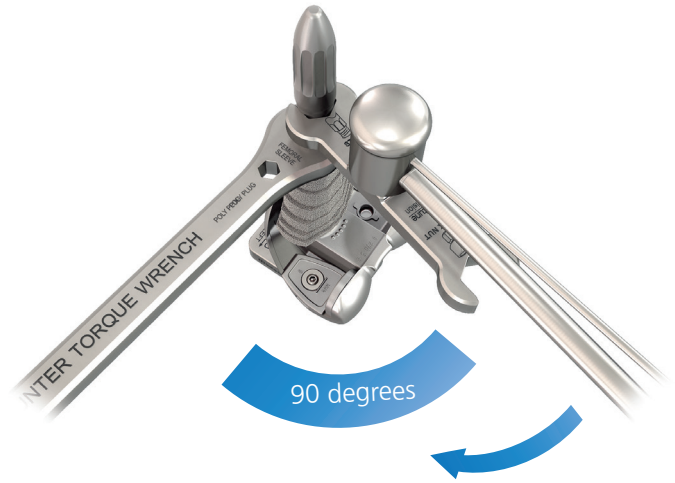

Gradually rotate the Implant Assembly Wrench towards the Sleeve Counter Torque Wrench until the marker is within the torque range marking. 

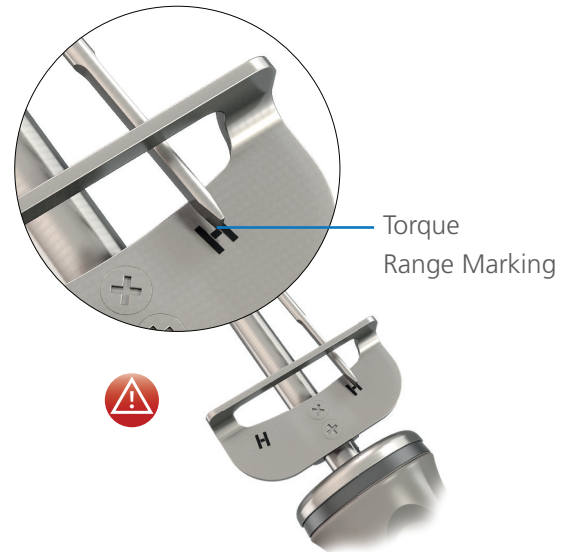

Using the alignment features of the Femoral Trial and Implant confirm visually that the Implant Sleeve is in the correct orientation relative to the Trial.



CAUTION

Do not apply so much torque that the marker fully passes the torque range marking.



Cementing Technique



Bone should be cleansed and dried prior to applying cement and implantation of all components.

During cementing of implants, movement of the components should be minimized while the cement is curing.

Things to consider:

- Avoid leaving dead space in the prepared bone
- When a Press-Fit Stem is to be implanted, no cement should be applied to the Stem or the medullary canal
- When implanting a Porous Coated Sleeve, do not put cement on the sleeve or in the medullary canal

For additional information on cementing, please refer to the “Guidance for Cementing Primary Total Knee Replacements” document.



CAUTION

Blood lamination can reduce the mechanical properties of the cement; therefore, it is vital to choose cement that reaches its working phase quickly. If applying cement to both the implant and bone, implantation should be completed early in its dough state to ensure good cement-cement adhesion and reduce the risk of dry laminations; which can weaken the cement.

Revision FB Tibial Construct alone or with Cemented Stems or Augments

Consider the use of a cement restrictor.

Apply a thick layer of cement to the bone, the implant surface or to both.

It is critical to ensure that cement fully surrounds the cone of the Revision FB Tibial Base Implant and any Cemented Stems or Augments.

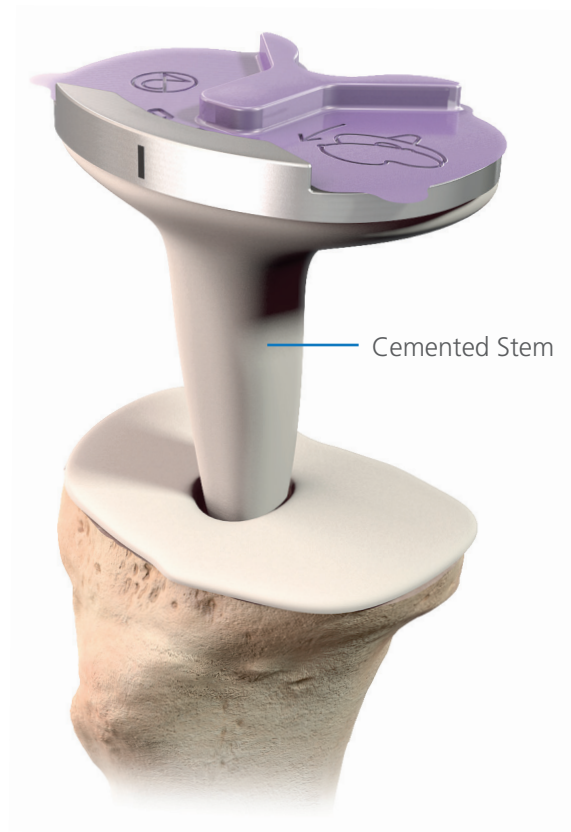

Revision FB Tibial Construct with Press-Fit Stems or Augments

Apply a thick layer of cement to the proximal tibial bone, the underside and cone of the Revision FB Tibial Base Implant and the bone contacting surface of any Tibial Augments. 

Care should be taken to avoid cement from contacting the Press-Fit Stem and being driven down the canal.

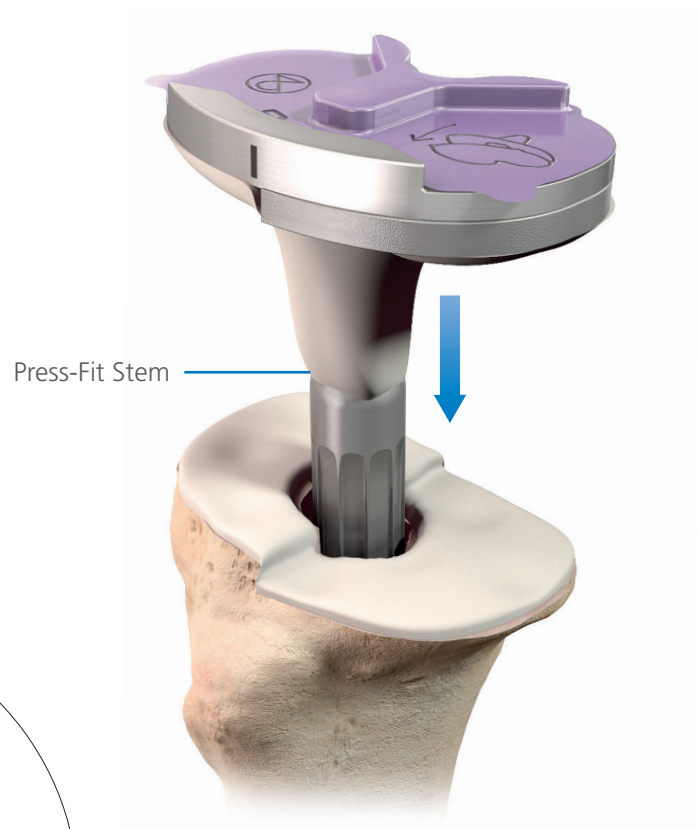

CAUTION

If cementing the Offset Adaptor, difficulties in extraction may be encountered.

Revision Femoral Construct with Cemented Stems, Augments, and/or Cemented Sleeves

Consider the use of a cement restrictor.

Apply a thick layer of cement to the Revision Femoral Component and any Cemented Stems, Augments or Sleeves and the femur.

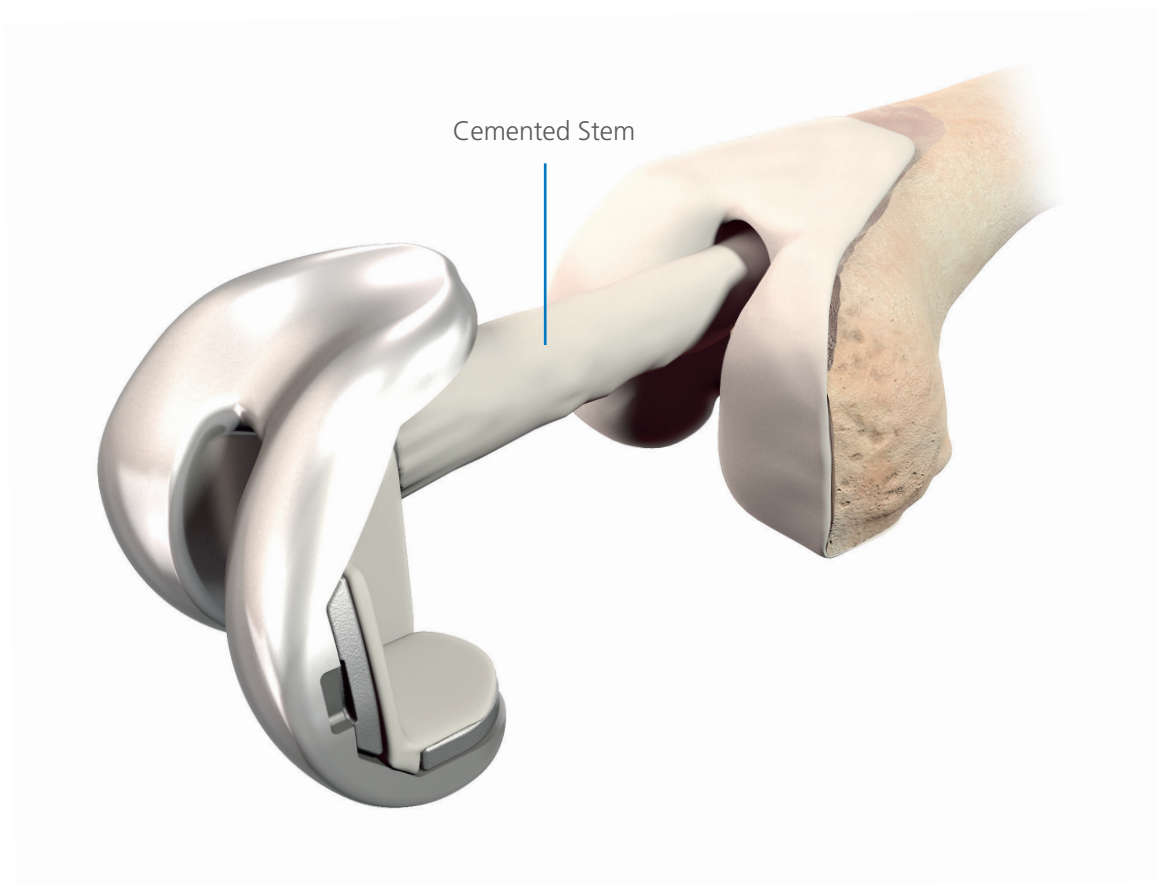

Revision Femoral Construct with Press-Fit Stems and Augments

Apply a thick layer of cement to the distal femoral bone, the Revision Femoral Component, and the bone contacting surface of any Augments.

Care should be taken to avoid cement from contacting the Press-Fit Stem and being driven down the canal. 

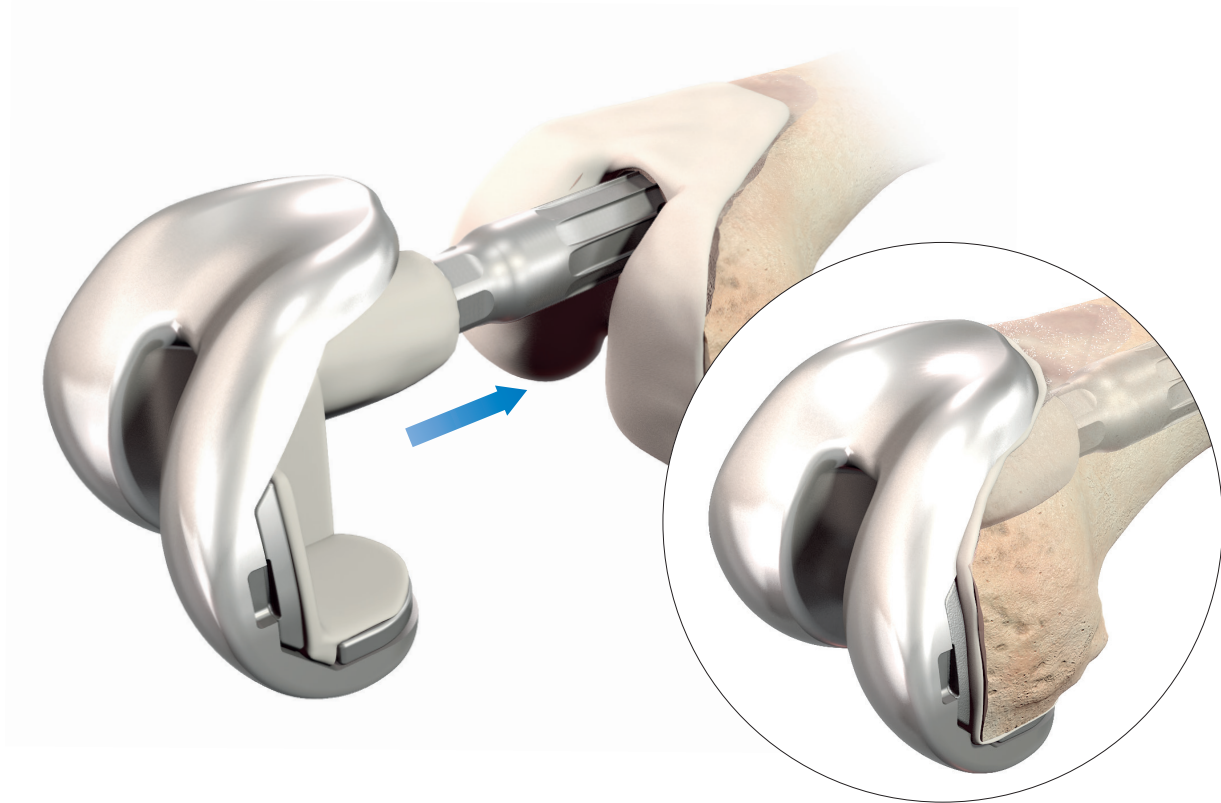

CAUTION

If cementing the Offset Adaptor, difficulties in extraction may be encountered.

Revision Femoral Construct with Press-Fit Stems and Porous Coated Sleeves and Augments

Apply a thick layer of cement to the distal femoral bone, the Revision Femoral Component, and the bone contacting surface of any Augments.

Care should be taken to avoid cement from contacting the Press-Fit Stem and the Porous Coated Sleeve and being driven down the canal.

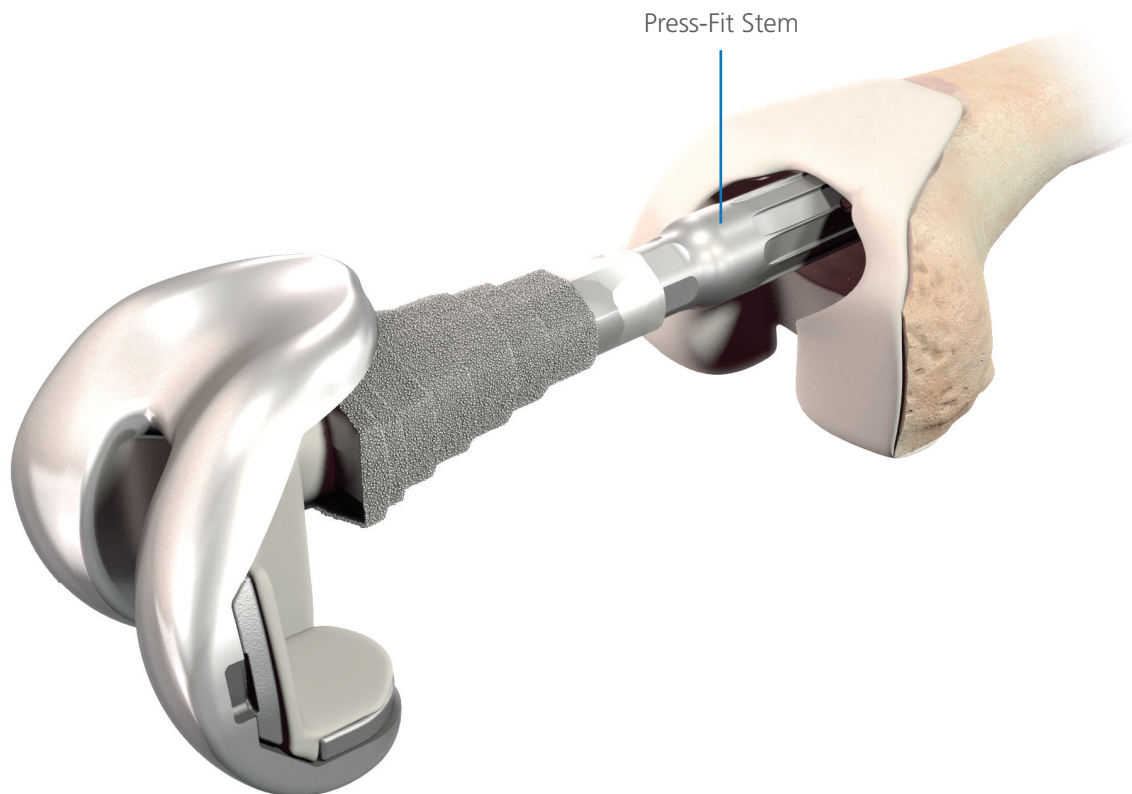

Seating the Tibial Construct

Carefully insert the Revision Tibial Base Implant using the ATTUNE System Impactor, avoiding malrotation.

Impact to seat the Revision Tibial Base Implant and to pressurize the cement. Then use a Curette to remove all extruded cement.



i INFORMATION

*The Fixed Bearing Tibial Base Implant should be directly impacted to the bone prior to mating with the polyethylene Tibial Insert as shown in the Tibial Insert Implantation section on **page 212**.*

The polyethylene Tibial Insert should not be attached to the Tibial Base prior to Tibial Base implantation.

! CAUTION

To prevent damage to the bearing surface, do not remove the Base Protector before impacting the Base. Care must be taken not to pull cement from under the edge of the implant in order to ensure the edges remain sealed.

Seating the Femoral Construct

Place the Revision Femoral Component Assembly onto the bone by hand.

Seat the Revision Femoral Component Assembly using the ATTUNE System Impactor.

Use only condylar impaction to seat the Revision Femoral Component Assembly. Notch impaction will attempt to extend the implant relative to the Stem or Sleeve and be in conflict with the bone preparation.

Then use a Curette to remove all extruded cement.

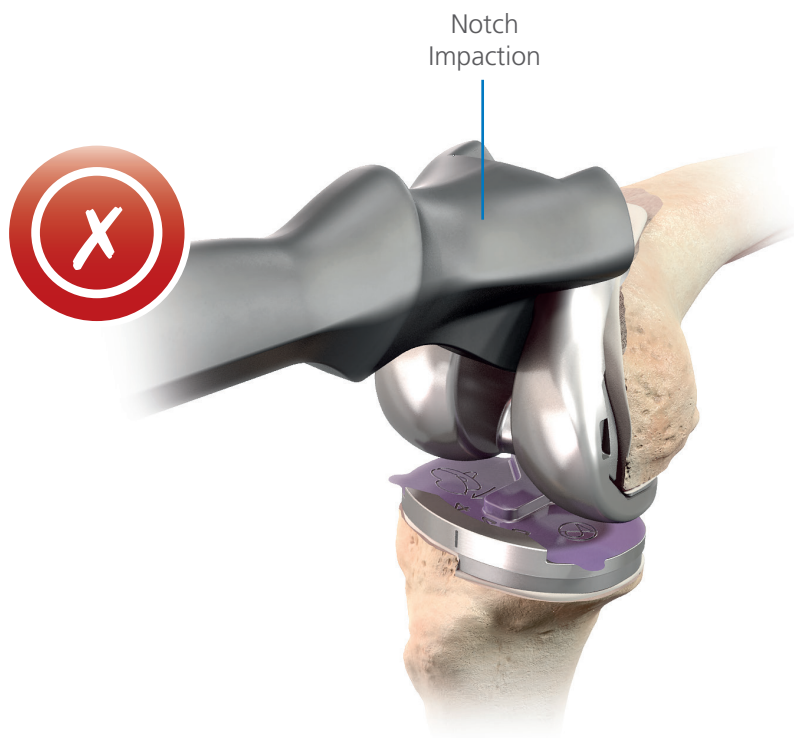
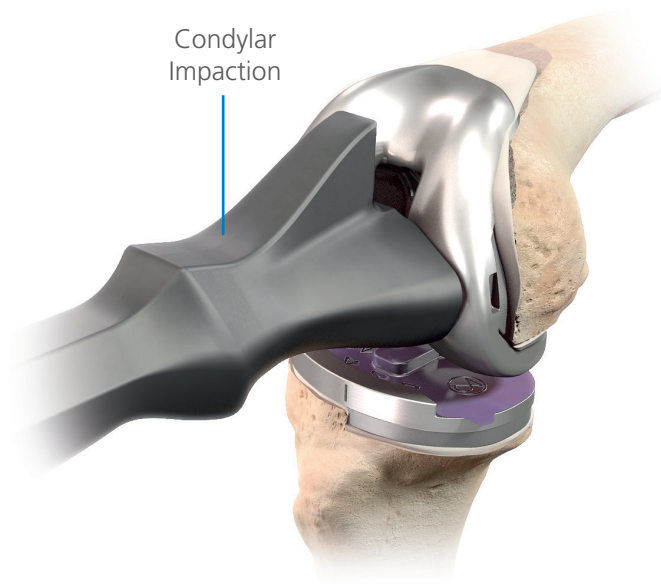

Solid Tibial Trial Extraction

A Trial reduction may be performed using a Tibial Insert Trial. The ATTUNE Primary INTUITION Insert Trial Handle can then be used to aid in removal of Tibial Insert Trials.

ATTUNE Primary INTUITION Insert Trial Handle



Connect the Insert Trial Handle to the anterior features on the Tibial Insert Trial and pull assembly up and out of the joint space to remove the Tibial Insert Trial.



This upward movement works with the geometry of the condyles to aid in removal of the Revision Tibial Insert Trial.

Lift the handle of the ATTUNE Primary INTUITION Insert Trial Handle

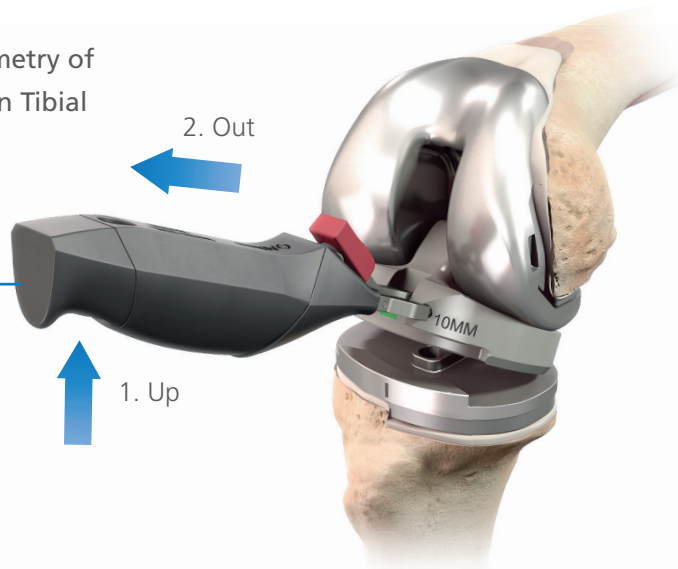

Tibial Insert Implantation

Remove any loose fragments or particulates from the final Tibial Base.

For Fixed Bearing Tibial Base components, the Revision Tibial Insert must be inserted vertically into the Fixed Bearing Tibial Base.

First, engage the Reinforcement Pin into the central hole in the Fixed Bearing Tibial Base.

Second, ensure that the anterior recess on the Insert is aligned with the anterior locking features of the Tibial Base.

Third, using the Revision FB Insert Impactor, impact the Fixed Bearing Insert to engage the locking mechanism of the Insert into the Base.



PS or CR Tibial Insert Implantation

If an ATTUNE PS or CR Insert is being utilized with the Revision Fixed Bearing Tibial Base, angle the Tibial Insert posteriorly and slide the posterior tabs into the posterior undercuts of the Tibial Base.



The Fixed Bearing Tibial Insert is impacted into place on the Tibial Base, using the Fixed Bearing Insert Impactor.

Position the Impactor at approximately 60 degrees on the Insert so that the notch rests on the anterior edge of the center of the insert. Use a mallet to strike the Fixed Bearing Insert Impactor.

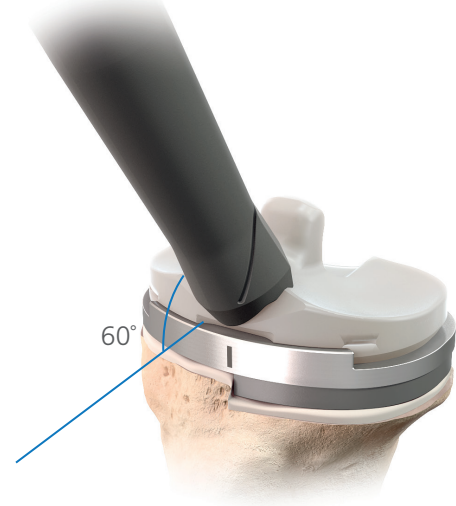

Final Patella Preparation



Connect the Patella Clamp Button Holder to the Patella Drill Clamp.

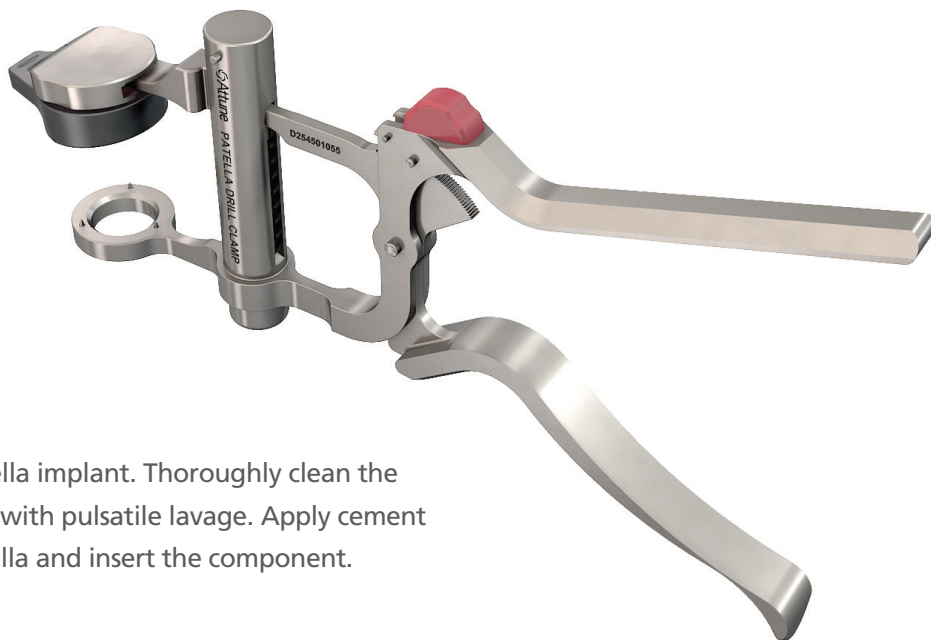

Apply cement to the patella implant. Thoroughly clean the cut surface of the patella with pulsatile lavage. Apply cement to the surface of the patella and insert the component.

Patella Component Implantation

The Medialized Dome or Medialized Anatomic Patella Buttons are designed to fully seat and stabilize the implant as the cement polymerizes.

Center the Medialized Dome or Medialized Anatomic Patella Button and Button Holder Assembly over the articular surface of the implant and the metal backing plate against the anterior cortex of the patella, avoiding skin entrapment.

Engage the Patella Drill Clamp to firmly hold the Patella Implant until polymerization is complete. Remove all extruded cement with a Curette.

Release the Patella Drill Clamp by unlocking the Locking-Switch on the handle and slightly squeezing the Patella Drill Clamp Handles to disengage the locking mechanism.



Reduce the patella.

Final Medialized
Dome Patella

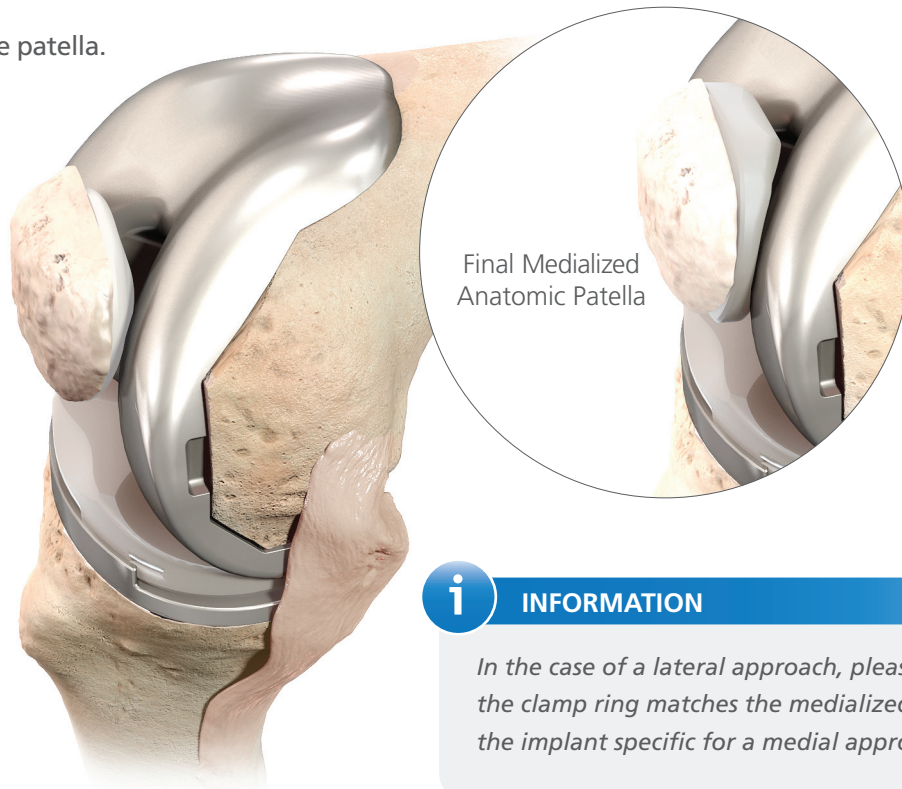

INFORMATION

In the case of a lateral approach, please consider that the clamp ring matches the medialized geometry of the implant specific for a medial approach.

Final Cement Curing

Confirm seating by circumferential inspection. Move the leg into extension, and then lift the leg back into flexion for final removal of excess cement.

Once all components are implanted, extending the leg will further pressurize the cement. The leg should then remain in extension until the cement hardens for the appropriate time depending on the cement type used. 



CAUTION

Care should be taken when flexing the knee past 45 degrees to avoid putting force on the posterior aspect of the Tibial Base while the cement is curing.

Femoral Sleeve Disassembly

Should a Femoral Sleeve Implant need to be removed from an ATTUNE Revision Femoral Component Implant, use the Femoral Sleeve Taper Separator:

Fully thread the Femoral Sleeve Taper Separator Base into the Revision Femoral Implant utilizing the 6 mm Hex Attachment with the T-Handle Torque Driver until tight.

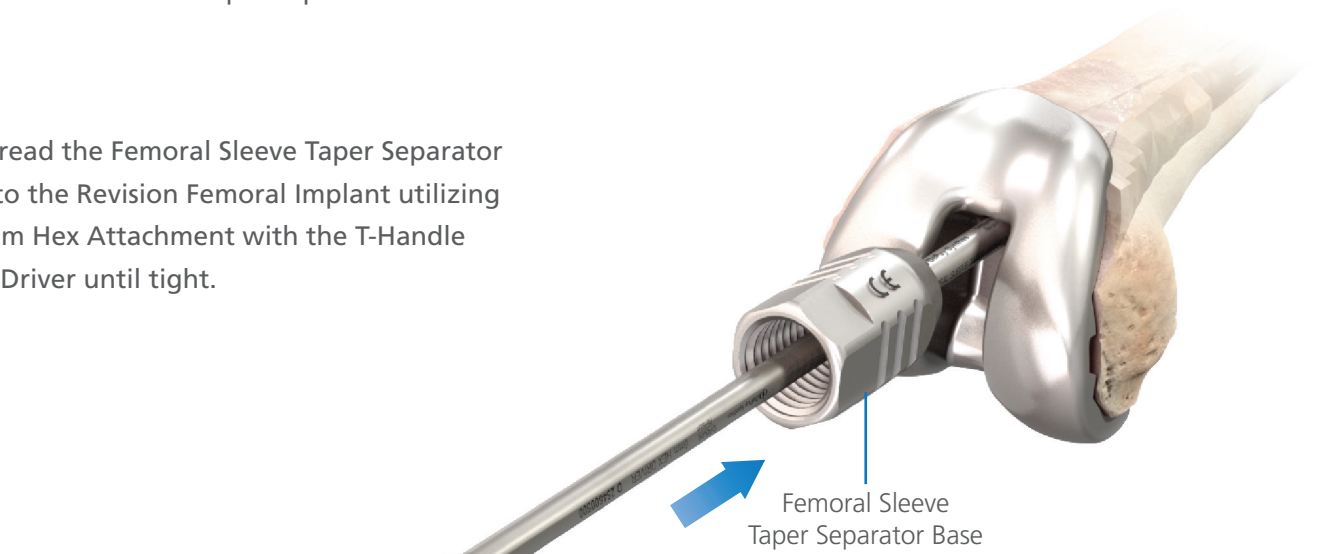

Fully insert the Femoral Sleeve Separator Push Rod into the Femoral Sleeve Taper Separator Base.

Femoral Sleeve Separator Push Rod

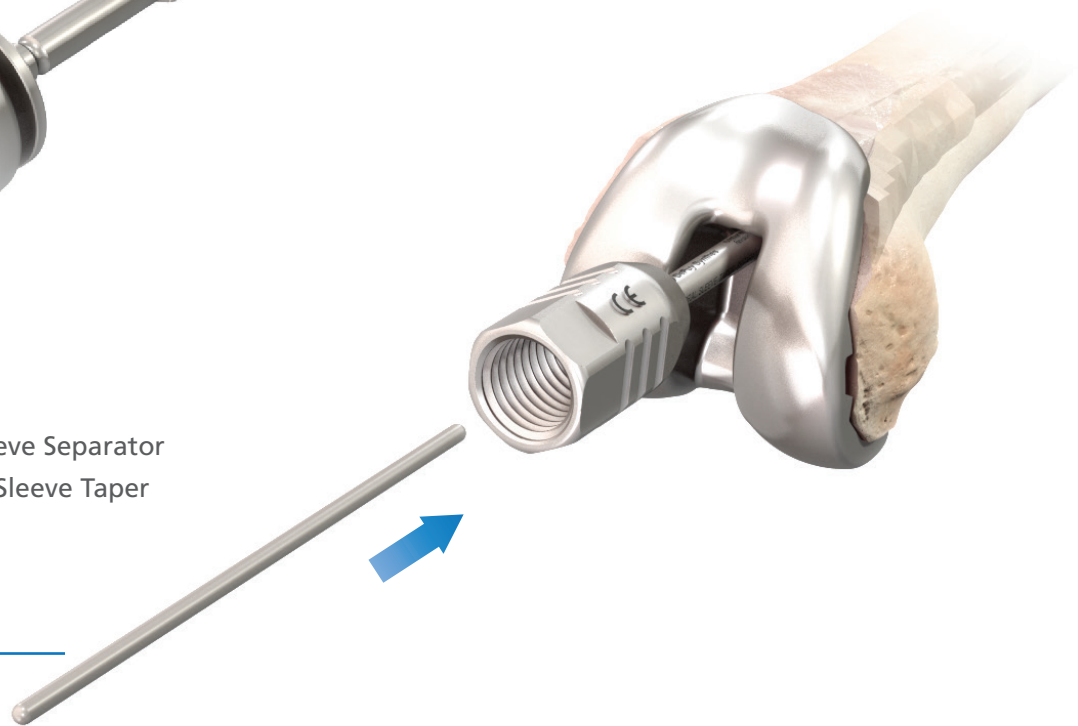

Femoral Sleeve Disassembly

Thread the Femoral Sleeve Taper Separator Driver into the Femoral Sleeve Taper Separator Base.

Femoral Sleeve Taper Separator Driver



Place the Hex of the Taper Separator Hex Wrench onto the Femoral Sleeve Taper Separator Base. Place the hex of the Taper Separator Rod/Handle onto the Femoral Sleeve Taper Separator Driver.

Hold the Taper Separator Hex Wrench while turning the Taper Separator Rod/Handle clockwise until the Revision Femoral Implant separates from the Femoral Sleeve.

Taper Separator Hex Wrench

Taper Separator Rod/Handle

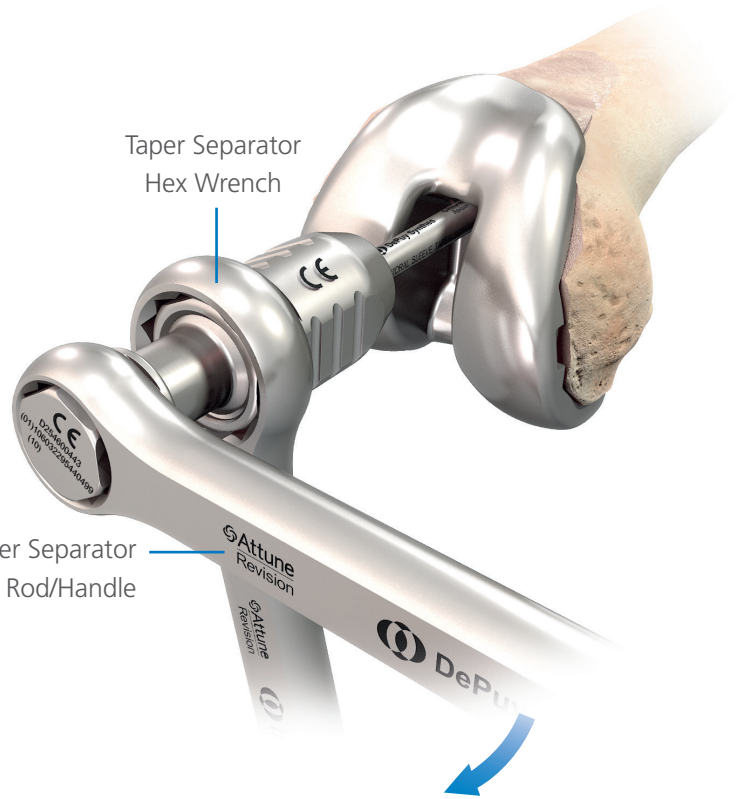

INFORMATION

If unable to disassemble the Sleeve after applying an initial torque, it may be necessary to tap the end of the Separator Driver with a Mallet, re-adjust wrench placement, and reapply torque with the wrenches.

Appendix A: Femoral Preparation with the KINCISE™ Surgical Automated System

Femoral Sleeve and Stem



Conventional Cut Guide

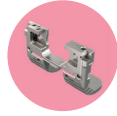

FE Guide



Femoral Sleeve and Stem

Assemble the corresponding Stem Trial to the smallest Femoral Broach.

Connect the correct side, "Left or Right", Broach Stop of the appropriate size grouping, 1-3, 4-7, 8-10, to the KINCISE ATTUNE Revision Broach Adapter.

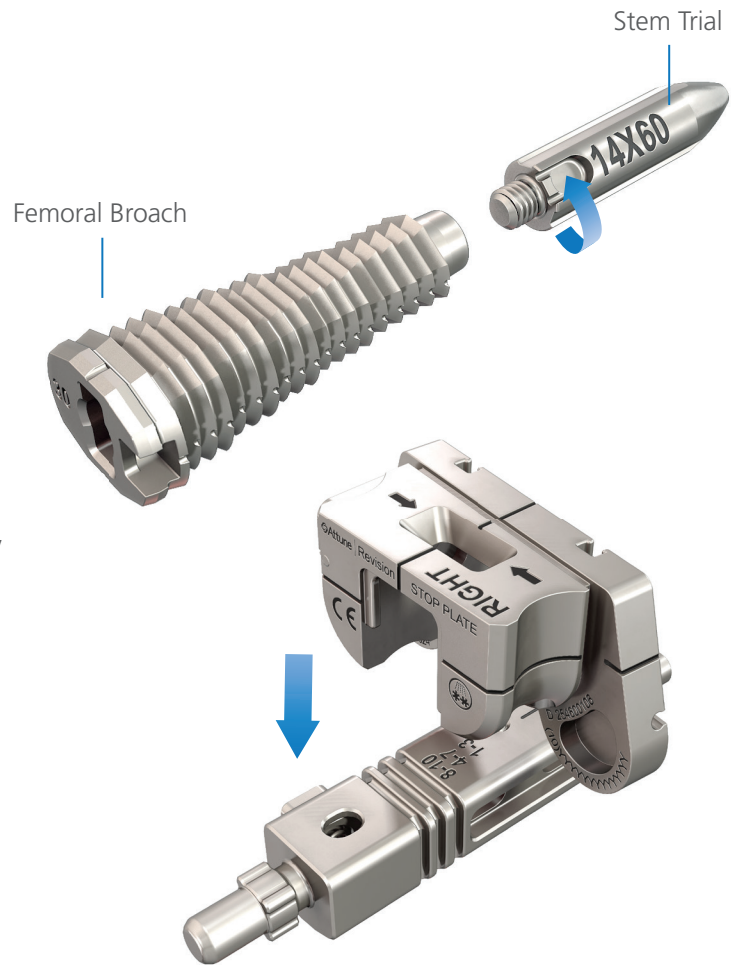

CAUTION

A Broach Stop must be utilized when broaching the femur.

Appendix A: Femoral Preparation with the KINCISE™ Surgical Surgical Automated System

Femoral Sleeve and Stem



Conventional Cut Guide

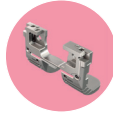

FE Guide



Femoral Sleeve and Stem

Connect the Broach Assembly to the KINCISE Surgical Impactor and introduce to the reamed femoral canal.

To connect the KINCISE ATTUNE Revision Broach Adapter to the KINCISE Surgical Impactor, rotate the Locking Collar to the unlocked position by aligning the arrow symbol on the Locking Collar with the unlock symbol on the body.

Insert the KINCISE ATTUNE Revision Broach Adapter into the KINCISE Surgical Impactor then rotate the Locking Collar back to the locked position.

Connect the 30 mm Femoral Broach to the KINCISE ATTUNE Revision Broach Adapter. Press the thumb button to open the latch to allow for connection to the Broach.

Position of the Femoral Broach should be done as described on Page 85 of this technique.

By pulling the trigger on the KINCISE Surgical Impactor, impact the Broach into the femur until the Broach Stop or Broach Stop/Shim is contacting the most prominent aspect of the distal femur. If there is significant bone loss on the distal femur, consider putting Broach Stop Shims on the Broach Stop to aid in to replicate the expected joint line when broaching.

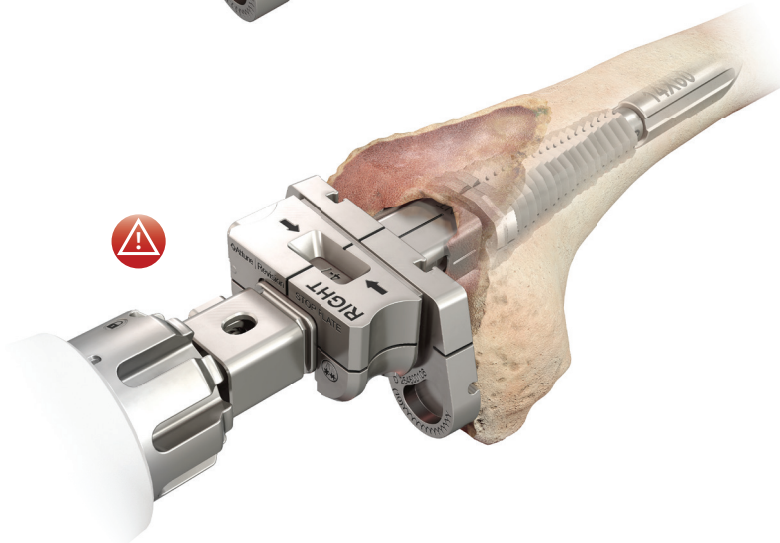
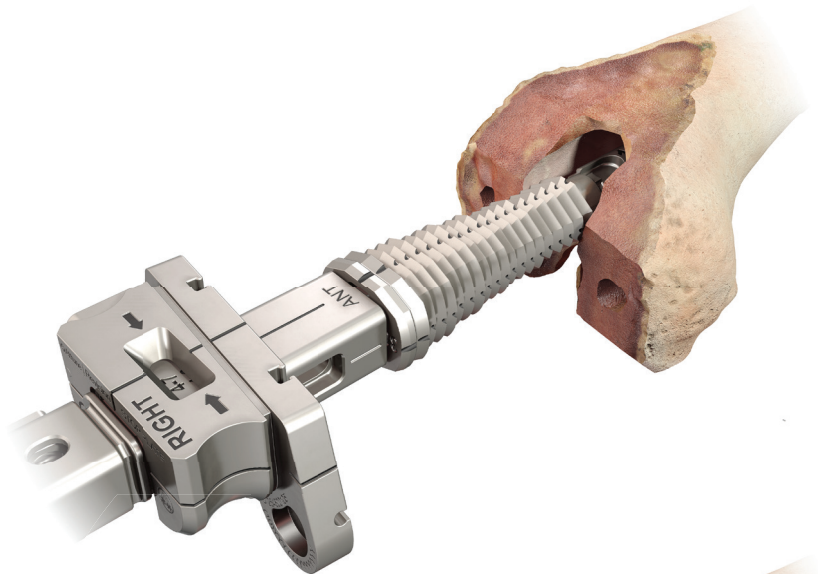

CAUTION

Ensure the Broach Adapter is fully locked to the handpiece before use to prevent the Adapter from disengaging during use.

Appendix A: Femoral Preparation with the KINCISE™ Surgical Automated System

Distal Clean-Up Resection



Conventional Cut Guide

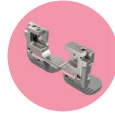

FE Guide



Femoral Sleeve and Stem

If desired, once rotational stability and the corresponding Broach size are achieved, a distal clean-up resection may be performed using the proximal surface of the Broach Stops or Broach Stop Shim, if used. If a resection is performed, reseat the Broach.

Disconnect the Broach from the KINCISE ATTUNE Revision Broach Adapter, leaving the Femoral Broach in the bone.

Continue to follow the steps for Femoral Preparation on Page 90 to complete prep for final Sleeve and Stem.

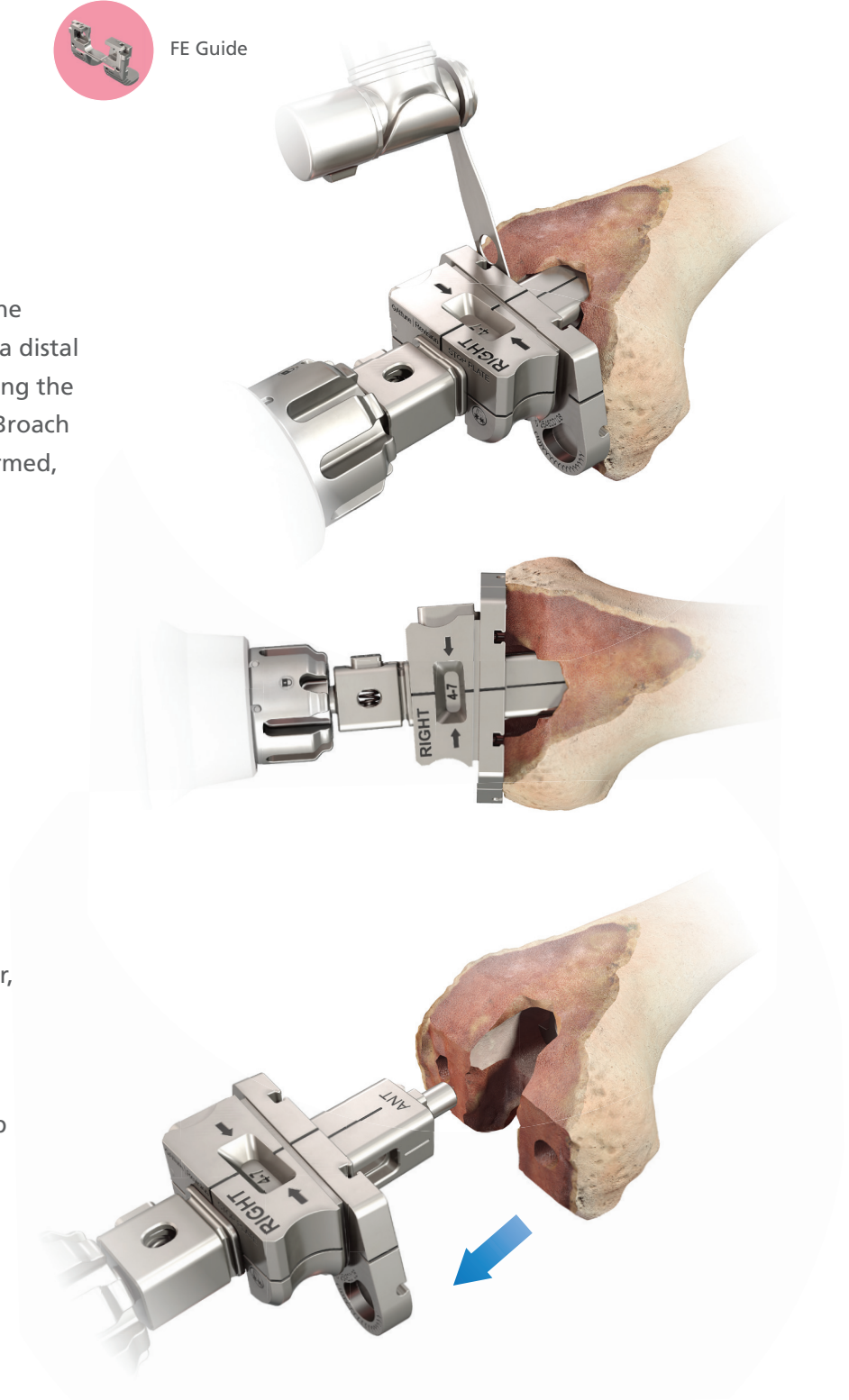

Compatibility Information

ATTUNE Revision FB Tibial Insert to ATTUNE Revision CRS Femoral Component /
ATTUNE Revision FB Tibial Base Compatibility¹

		ATTUNE Revision CRS Femoral Component	ATTUNE Revision FB Tibial Base
Tibial Insert	ATTUNE CR FB Tibial Insert	No	Yes
	ATTUNE PS FB Tibial Insert	Yes	Yes
	ATTUNE Revision CRS FB Insert	Yes	Yes

Patella to ATTUNE Revision CRS Femoral Component Compatibility¹



		ATTUNE Revision CRS Femoral Component
Patella	ATTUNE Medialized Dome	Yes
	ATTUNE Medialized Anatomic	Yes

ATTUNE Revision Femoral Sleeve to ATTUNE Revision Offset Adaptor Compatibility¹

	ATTUNE Revision Offset Adaptor
ATTUNE Revision Femoral Sleeves	No
ATTUNE Revision Cemented Stems	No
ATTUNE Revision CRS Femoral Component	Yes
ATTUNE Revision FB Tibial Base	Yes
ATTUNE Revision Press-Fit Stems	Yes

Compatibility Data

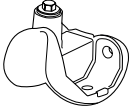

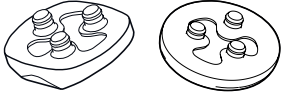



Table 7: ATTUNE Revision Knee Compatibility Chart¹









SIZE SZ																			
Pink	1	1	1	2	3										29	32	35	38	41
Dark Blue	2	2	1	2	3	4									29	32	35	38	41
Grey	3	3	1	2	3	4	5								29	32	35	38	41
Black	4	4		2	3	4	5	6								32	35	38	41
Green	5	5			3	4	5	6	7							32	35	38	41
Yellow	6	6				4	5	6	7	8						32	35	38	41
Light Blue	7	7					5	6	7	8	9						35	38	41
Red	8	8						6	7	8	9	10					35	38	41
Purple	9	9							7	8	9	10						38	41
Brown	10	10								8	9	10						38	41

Symbols on Surgical Instruments

Some of the instruments have markings on them for guidance.

The interpretation of these markings is as detailed in the table below.

Symbol or Text	Definition
	Cleaning position here
	Dismantle for cleaning
	Unlock
	Lock
L	Left
R	Right
CR	ATTUNE Cruciate Retaining Implant
PS	ATTUNE Posterior Stabilized Implant
FB	Fixed Bearing
L	Lateral (for Patella Trials)
M	Medial (for Patella Trials)
LL	Left Lateral
RL	Right Lateral
	Femoral Implant Icon
	Base Protector
FEM	Femur
ANT	Anterior

Symbol or Text	Definition
FLEXION	Flexion
EXTENSION	Extension
SZ	Size
TIB	Tibia
	Caution
DEG	Degrees
CEM	Cemented
LM	Left Medial
RM	Right Medial
	Cemented/Press-Fit Stem Assembly Icon
	Offset Adaptor Assembly Icon
	Femoral Implant Icon
	Femoral Trial Icon
	Indication Arrow
	Tibial Implant Icon
	Offset Adaptor Gap Assessment Icon

Reference

1. Data on file at DePuy Orthopaedics, Inc. SEA 103236081.



DePuy Orthopaedics, Inc.
700 Orthopaedic Drive
Warsaw, IN 46582
USA
Tel: +1 (800) 366-8143
Fax: +1 (800) 669-2530

DePuy International, Ltd.
St Anthony's Road
Leeds LS11 8DT
England
Tel: +44 (0) 113 270 0461

DePuy (Ireland)
Loughbeg, Ringaskiddy
Co. Cork, Ireland
Tel: +35 (321) 491 4000
Fax: +35 (321) 491 4199



www.depuysynthes.com